

VOLKSWAGEN

AKTIENGESELLSCHAFT



*moving*  
ideas

ANNUAL REPORT

*2013*

# Key Figures

## VOLKSWAGEN GROUP

Volume data <sup>1</sup>	2013	2012	%
Vehicle sales (units)	9,728,250	9,344,559	+4.1
Production (units)	9,727,848	9,255,384	+5.1
Employees at Dec. 31	572,800	549,763	+4.2
Financial data (IFRSs), € million	2013	2012 <sup>2</sup>	%
Sales revenue	197,007	192,676	+2.2
Operating profit	11,671	11,498	+1.5
Profit before tax	12,428	25,487	-51.2
Profit after tax	9,145	21,881	-58.2
Profit attributable to Volkswagen AG shareholders	9,066	21,712	-58.2
Cash flows from operating activities	12,595	7,209	+74.7
Cash flows from investing activities attributable to operating activities	14,936	16,840	-11.3
Automotive Division <sup>3</sup>			
EBITDA <sup>4</sup>	20,594	19,895	+3.5
Cash flows from operating activities	20,612	16,232	+27.0
Cash flows from investing activities attributable to operating activities <sup>5</sup>	16,199	16,455	-1.6
of which: investments in property, plant and equipment	11,040	10,271	+7.5
as a percentage of sales revenue	6.3	5.9	
capitalized development costs	4,021	2,615	+53.8
as a percentage of sales revenue	2.3	1.5	
Net cash flow	4,413	-223	x
Net liquidity at Dec. 31	16,869	10,573	+59.5
Return ratios in %	2013	2012	%
Return on sales before tax	6.3	13.2	
Return on investment (RoI) in the Automotive Division	14.5	16.6	
Return on equity before tax (Financial Services Division) <sup>6</sup>	14.3	13.1	

1 Volume data including the unconsolidated Chinese joint ventures.

2 Prior-year figures adjusted to reflect application of IAS 19R.

3 Including allocation of consolidation adjustments between the Automotive and Financial Services divisions.

4 Operating profit plus net depreciation/amortization and impairment

losses/reversals of impairment losses on property, plant and equipment, capitalized development costs, leasing and rental assets, goodwill and financial assets as reported in the cash flow statement.

5 Excluding acquisition and disposal of equity investments: €14,497 million (€12,528 million).

6 Profit before tax as a percentage of average equity.

## VOLKSWAGEN AG

Volume data	2013	2012	%
Vehicle sales (units)	2,495,745	2,580,266	-3.3
Production (units)	1,169,151	1,148,774	+1.8
Employees at Dec. 31	107,559	101,794	+5.7
Financial data (HGB), € million	2013	2012	%
Sales	65,587	68,361	-4.1
Net income for the year	3,078	6,380	-51.8
Dividends (€)			
per ordinary share	4.00	3.50	
per preferred share	4.06	3.56	

This version of the annual report is a translation of the German original. The German takes precedence.

# Moving Globally

Key Figures

Moving Globally

VOLKSWAGEN GROUP DELIVERIES – IN THOUSAND UNITS

## NORTH AMERICA

2011 668  
2012 843  
2013 891

+5.6%

## EUROPE/REMAINING MARKETS

2011 4,058  
2012 4,170  
2013 4,201

+0.7%

## SOUTH AMERICA

2011 963  
2012 1,082  
2013 992

-8.3%

## ASIA-PACIFIC

2011 2,577  
2012 3,181  
2013 3,647

+14.7%

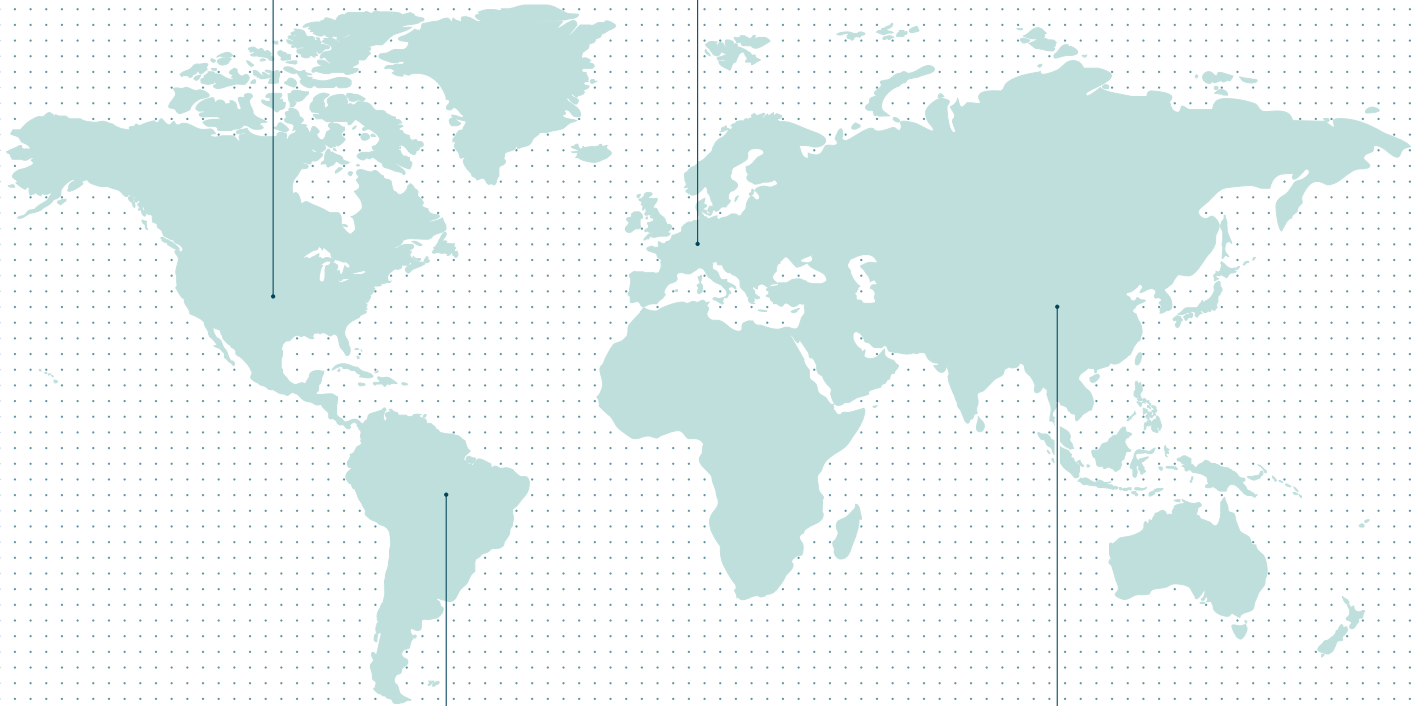



---

*Key Figures*

*Moving  
Globally*





*12 brands  
on the move*

# VOLKSWAGEN

AKTIENGESELLSCHAFT



Audi



SEAT

ŠKODA



BENTLEY



PORSCHE



Commercial  
Vehicles



SCANIA



# VOLKSWAGEN FINANCIAL SERVICES

AKTIENGESELLSCHAFT

Twelve brands  
with an individual identity  
and a common goal:  
mobility. For everyone, all  
over the world.



*Volkswagen is “Das Auto”.*  
*The brand delivers innovative, responsible mobility*  
*to many people – all over the world.*



*e-up!*



Volkswagen e-up! 60 kW energy consumption in kWh/100 km combined 11.7; CO<sub>2</sub> emissions in g/km combined 0.

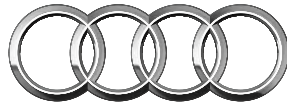

**Audi**

*Audi is “Vorsprung durch Technik”. Lightweight construction, efficient drivetrains and innovative assistance systems – Audi covers its progressive technologies in clear lines and sporty design.*

A3 Sportback e-tron



Audi A3 Sportback e-tron 150 kW fuel consumption in l/100 km combined 1.5; CO<sub>2</sub> emissions in g/km combined 35.



León ST



SEAT León ST fuel consumption in l/100 km combined from 5.9 to 3.2; CO<sub>2</sub> emissions in g/km combined from 137 to 85.



*SEAT combines temperament and precision.  
The Mii, Ibiza, or León: the Spanish brand's  
cars thrill people with their emotional design,  
high quality and engineering perfection.*



**ŠKODA**



*Clever solutions for everyday car journeys – that is ŠKODA's aspiration. The traditional Czech brand combines functionality and everyday practicality with high quality and timeless design.*



*Rapid Spaceback*



ŠKODA Rapid Spaceback fuel consumption in l/100 km combined from 5.8 to 3.8; CO<sub>2</sub> emissions in g/km combined from 134 to 99.

W12 Flying Spur



Bentley W12 Flying Spur 460 kW fuel consumption in l/100 km urban 22.4/extra-urban 10.2/combined 14.7; CO<sub>2</sub> emissions in g/km combined 343.





**BENTLEY**

*To build the best car in its class – that was the dream  
of Walter Owen Bentley, racing driver and entrepreneur.*

*This high standard still holds today – every Bentley  
delivers tailored luxury, perfect craftsmanship and  
powerful performance.*



*A car or a work of art? A Bugatti is both.  
The Molsheim manufacturing facility produces  
aesthetically and technically unique cars  
that travel faster than any other super sports car.*

---

*Veyron 16.4 Grand Sport Vitesse*



Bugatti Veyron 16.4 Grand Sport Vitesse 882 kW fuel consumption in l/100 km urban 37.2 / extra-urban 14.9 / combined 23.1; CO<sub>2</sub> emissions in g/km combined 539.

---

*Aventador LP 700-4 Roadster*



Lamborghini Aventador LP 700-4 Roadster 515 kW fuel consumption in l/100 km urban 24.7 / extra-urban 10.7 / combined 16.0; CO<sub>2</sub> emissions in g/km combined 370.



*An uncompromisingly sporty identity, extreme design,  
ultimate performance – that is what Lamborghini stands for.  
The ultra-lightweight machines from Sant’Agata  
Bolognese are the epitome of Italian sports car engineering.*



PORSCHE

*Porsche's mission is to build sports cars that go at full throttle on the circuit but also hold their own on everyday journeys. German engineering brilliance creates the most efficient sports cars in the world.*

918 Spyder



Porsche 918 Spyder 652 kW fuel consumption in l/100 km combined 3.1; energy consumption in kWh/100 km combined 12.7; CO<sub>2</sub> emissions in g/km combined 72.



---

*Panigale R*





*A Ducati is not a motorcycle, it's a way of life.  
Push yourself and your machine to the max, without  
compromises, a life of freedom. The tremendous  
emotion is backed by superior engine technology and  
innovative lightweight design.*



## **Commercial Vehicles**

*Volkswagen Commercial Vehicles specializes in satisfying individual mobility and transport needs. The light commercial vehicles Caddy, Transporter, Multivan, Crafter and Amarok all excel as reliable, flexible and economical companions for everyday use or for recreation.*



*Amarok Canyon*



Volkswagen Amarok Canyon fuel consumption in l/100 km combined from 8.5 to 7.6; CO<sub>2</sub> emissions in g/km combined from 224 to 199.



*Scania trucks, buses and engines  
offer maximum efficiency and absolute reliability.  
The premium brand in the commercial  
vehicles segment stands for high cost-effectiveness  
and comprehensive service.*

*Streamline*



TCX in Euro 6 standard





*Technical expertise based on over 250 years of innovation can be found in all of MAN's products: its trucks and buses as well as large-bore engines and turbines.*





# VOLKSWAGEN FINANCIAL SERVICES

THE KEY TO MOBILITY

*Volkswagen Financial Services are the key to mobility  
for the Group's customers. Tailored financial  
services mean that many people are able to realize  
their dream of owning a car.*

# Contents

1

## STRATEGY

- 07 Report of the Supervisory Board
- 12 Letter to our Shareholders
- 16 The Board of Management of Volkswagen Aktiengesellschaft

2

## DIVISIONS

- 21 Brands and Business Fields
- 24 Volkswagen Passenger Cars
- 26 Audi
- 28 ŠKODA
- 30 SEAT
- 32 Bentley
- 34 Porsche
- 36 Volkswagen Commercial Vehicles
- 38 Scania
- 40 MAN
- 42 Volkswagen Group China
- 44 Volkswagen Financial Services

3

## GROUP MANAGEMENT REPORT

- 49 Goals and Strategies
- 50 Internal Management System and Key Performance Indicators
- 52 Structure and Business Activities
- 54 Corporate Governance Report
- 60 Remuneration Report
- 65 Executive Bodies
- 69 Disclosures Required under Takeover Law
- 72 Business Development
- 85 Shares and Bonds
- 94 Results of Operations, Financial Position and Net Assets
- 109 Volkswagen AG (condensed, in accordance with the German Commercial Code)
- 113 Sustainable Value Enhancement
- 143 Report on Expected Developments
- 151 Report on Risks and Opportunities
- 164 Prospects for 2014

A large, stylized teal number '4' is positioned on the left side of the page. It is set against a background of a light teal dotted grid that extends to the right.A large, stylized teal number '5' is positioned on the right side of the page. It is set against a background of a light teal dotted grid that extends to the left.

**CONSOLIDATED FINANCIAL STATEMENTS**

**169** Income Statement  
**170** Statement of Comprehensive Income  
**172** Balance Sheet  
**174** Statement of Changes in Equity  
**176** Cash Flow Statement  
**177** Notes  
**283** Responsibility Statement  
**284** Auditor's Report

**ADDITIONAL INFORMATION**

**286** Glossary  
**287** Index  
**288** List of Tables  
**289** Contact Information  
**290** Scheduled Dates

This annual report was published on the occasion of the Annual Media Conference on March 13, 2014.

*“Our pursuit of innovation and perfection and our responsible approach will help to make us the world’s leading automaker by 2018 – both economically and ecologically.”*

PROF. DR. MARTIN WINTERKORN, CHAIRMAN OF THE BOARD OF MANAGEMENT OF VOLKSWAGEN AKTIENGESELLSCHAFT



*1*



*Strategy*

*2018*

# 1

STRATEGY

07	Report of the Supervisory Board
12	Letter to our Shareholders
16	The Board of Management of Volkswagen Aktiengesellschaft

8102

# *Report of the Supervisory Board*

---

(IN ACCORDANCE WITH SECTION 171(2) OF THE AKTG)

Ladies and Gentlemen,

in fiscal year 2013, the Supervisory Board of Volkswagen AG addressed the Company's position and development regularly and in detail. In compliance with the suggestions and recommendations of the German Corporate Governance Code and the legal requirements, we supported the Board of Management in its running of the business and advised it on issues relating to the management of the Company. The Supervisory Board was directly involved in all decisions of fundamental importance to the Group. In addition, we discussed current strategic considerations with the Board of Management at regular intervals.

The Supervisory Board was informed by the Board of Management regularly, promptly and comprehensively in writing or orally on the development of the business and the Company's planning and position, including the risk situation and risk management. In addition, the Board of Management reported to us on an ongoing basis on compliance-related topics and other topical issues. In all cases we received the documents relevant to our decisions in good time for our meetings. We also received a detailed monthly report from the Board of Management on the current business position and the forecast for the current year. Any variances in performance as against the plans and targets previously drawn up were explained by the Board of Management in detail, either orally or in writing. We analyzed the reasons for the variances together with the Board of Management so as to enable countermeasures to be derived.

The Chairman of the Supervisory Board consulted with the Chairman of the Board of Management at regular intervals between meetings about, among other things, the Volkswagen Group's strategy and planning, the development of the business, the Group's risk situation and risk management, and compliance issues.

The Supervisory Board held a total of five meetings in fiscal year 2013. The average attendance ratio was 93%; no member of the Supervisory Board took part in fewer than half of the meetings. In addition, resolutions on urgent matters were adopted in writing or using electronic communications media.

## **COMMITTEE ACTIVITIES**

The Supervisory Board has established a total of four committees in order to perform the duties entrusted to it: the Executive Committee, the Nomination Committee, the Mediation Committee in accordance with section 27(3) of the Mitbestimmungsgesetz (MitbestG – German Codetermination Act) and the Audit Committee. The Executive Committee consists of three shareholder representatives and three employee representatives. The members of the Nomination

Committee are the shareholder representatives on the Executive Committee; the remaining two committees are each composed of two shareholder representatives and two employee representatives. The members of the committees as of December 31, 2013 are given on page 68 of this annual report.

The Executive Committee met four times during the reporting period. These meetings primarily served to prepare in detail the resolutions by the Supervisory Board and to deal with contractual issues concerning the Board of Management other than remuneration.

The Nomination Committee is responsible for proposing suitable candidates for the Supervisory Board to recommend for election to the Annual General Meeting. The Committee met once during 2013.

The Mediation Committee did not have to be convened in the past fiscal year.

The Audit Committee met five times during the reporting period. It focused primarily on the consolidated financial statements, risk management (including the internal control system), and the work performed by the Company's compliance organization. In addition, the Audit Committee addressed the Group's quarterly reports and the half-yearly financial report as well as current financial reporting issues and their examination by the auditors. The Audit Committee also put the audit of the financial statements out to tender in the reporting period.

Furthermore, the shareholder and employee representatives met for separate preliminary discussions before each of the Supervisory Board meetings.

#### **TOPICS DISCUSSED BY THE SUPERVISORY BOARD**

At the Supervisory Board meeting on February 22, 2013 we approved, after a detailed examination, the consolidated financial statements prepared by the Board of Management and the annual financial statements of Volkswagen AG for 2012, as well as the combined management report. We also examined the dependent company report submitted by the Board of Management and came to the conclusion that there were no objections to be raised to the concluding declaration by the Board of Management in the report. Other items on the agenda included the revision of the rules governing the variable remuneration for the Board of Management, the approval of the decision on the location of a new production facility for the Shanghai-Volkswagen Automotive Company joint venture in South China and strategic financing measures at the Volkswagen Group. We also issued a supplementary declaration to the declaration of conformity with the German Corporate Governance Code dated November 23, 2012 at this meeting.

At the meetings on April 24 and 25, 2013 we prepared for, and performed a follow-up evaluation of, the 53rd Annual General Meeting of Volkswagen AG on April 25, 2013 and the conclusion of a control and profit and loss transfer agreement with MAN SE. We also resolved on the composition of the Executive Committee of the Supervisory Board.

Among other things, we approved the issue of a mandatory convertible note in resolutions that were adopted by circulating written documents in June 2013.



At the Supervisory Board meeting on September 20, 2013, we primarily discussed strategic issues and received a comprehensive status report on the control and profit and loss transfer agreement with MAN SE.

The Supervisory Board meeting on November 22, 2013 addressed in detail, and subsequently approved, the Volkswagen Group's investment and financial planning for the period from 2014 to 2018. Other topics dealt with at the meeting included in particular the annual declaration of conformity with the German Corporate Governance Code and increasing the standard age limit for proposals for elections to the Supervisory Board.

#### **CONFLICTS OF INTEREST**

Mr. Jürgen Dorn, member of the Supervisory Board of Volkswagen AG, who is also a member of the Supervisory Boards of MAN SE and MAN Truck & Bus AG, did not take part in the resolution on April 24, 2013 on the conclusion of a control and profit and loss transfer agreement with MAN SE. The Chairman of the Supervisory Board of Volkswagen AG, who is also the Chairman of the Supervisory Board of MAN SE, participated in the resolution.

At the above-mentioned meeting, the Supervisory Board also resolved that the Board of Management of Volkswagen AG would vote at the Annual General Meeting of AUDI AG to elect Ms. Ursula Piëch to the Supervisory Board and to elect the remaining shareholder representatives on the Supervisory Board of AUDI AG for an additional term of office. Ms. Ursula Piëch, who is a member of the Supervisory Board of Volkswagen AG, did not participate in this resolution.

At its meeting on November 22, 2013, the Supervisory Board approved the acquisition of the MAN financial services companies by Volkswagen Financial Services AG companies. Mr. Jürgen Dorn abstained from voting. Prof. Dr. Ferdinand K. Piëch took part in the vote.

At its meetings on April 24 and November 21, 2013, the Executive Committee of the Supervisory Board addressed topics previously dealt with by the Committee for Major Shareholder Business Relationships (Ausschuss für Geschäfte mit Großaktionären – AFGG), which was dissolved on September 21, 2012. In this context, the Executive Committee granted individual approvals to transactions with Porsche Automobil Holding SE and the State of Lower Saxony. The Executive Committee members who are also members of the Supervisory Board of Porsche Automobil Holding SE took part in the votes. Executive Committee member Mr. Stephan Weil is Minister-President of the State of Lower Saxony and also took part in the votes. The Executive Committee members were guided exclusively by the interests of the Company when voting. No material conflicts of interest were discernible in this respect. All approvals were granted unanimously.

No other discernible conflicts of interest were reported or arose in the reporting period.

#### **CORPORATE GOVERNANCE AND DECLARATION OF CONFORMITY**

The application of the German Corporate Governance Code at the Volkswagen Group was discussed at the Supervisory Board meetings on February 22 and November 22, 2013: in February, we issued a supplementary declaration to our declaration of conformity dated November 23, 2012, while in November we addressed the changes to the Code published by the Government Commission on the German Corporate Governance Code on June 10, 2013 and issued the annual declaration on the Code's recommendations in accordance with section 161 of the AktG together with the Board of Management.

The joint declarations of conformity by the Board of Management and the Supervisory Board are permanently available on the Volkswagen AG website at [www.volkswagenag.com/ir](http://www.volkswagenag.com/ir). Additional information on the implementation of the recommendations and suggestions of the German Corporate Governance Code can be found in the corporate governance report starting on page 54 and on page 282 of the notes to the consolidated financial statements.

#### **MEMBERS OF THE SUPERVISORY BOARD AND BOARD OF MANAGEMENT**

Wolfgang Ritmeier, Jürgen Stumpf and Bernd Wehlauer resigned from the Supervisory Board of Volkswagen AG at the end of 2012. Effective January 1, 2013, Dr. Hans-Peter Fischer, Chairman of the Board of Management of the Volkswagen Management Association, Jürgen Dorn, Chairman of the Group Works Council and SE Works Council of MAN SE, and Stephan Wolf, Deputy Chairman of the General and Group Works Council of Volkswagen AG, were appointed by the court to the Supervisory Board of Volkswagen AG as their successors.

Effective February 19, 2013, the State of Lower Saxony appointed the Minister-President, Stephan Weil, and the Minister of Economic Affairs, Labor and Transport, Olaf Lies, to the Supervisory Board of Volkswagen AG. They succeeded David McAllister and Jörg Bode, who stepped down from the Supervisory Board as of the same day.

Jassim Al-Kuwari stepped down from the Supervisory Board of Volkswagen AG as of April 25, 2013. He was succeeded by Ahmad Al-Sayed, who was appointed by the court as his replacement on the Supervisory Board effective June 28, 2013.

The scheduled term of office of Dr. Wolfgang Porsche as a member of Volkswagen AG's Supervisory Board expired at the end of the 53rd Annual General Meeting on April 25, 2013. The Annual General Meeting elected Dr. Porsche to the Supervisory Board for a further full term of office.

There were no changes to the Board of Management during the reporting period.

#### **AUDIT OF THE ANNUAL AND CONSOLIDATED FINANCIAL STATEMENTS**

The Annual General Meeting on April 25, 2013 elected PricewaterhouseCoopers Aktiengesellschaft Wirtschaftsprüfungsgesellschaft as auditors for fiscal year 2013. The auditors audited the annual financial statements of Volkswagen AG, the consolidated financial statements of the Volkswagen Group and the combined management report, and issued unqualified audit reports on all of these documents. In addition, they analyzed the risk management and internal control systems, concluding that the Board of Management had taken the measures required by section 91(2) of the AktG to ensure early detection of any risks endangering the continued existence of the Company. The Report by Volkswagen AG on Relationships with Affiliated Companies in Accordance with section 312 of the AktG for the period from January 1 to December 31, 2013 (dependent company report) submitted by the Board of Management was also audited by the auditors, who issued the following opinion: "In our opinion and in accordance with our statutory audit, we certify that the factual disclosures provided in the report are correct and that the Company's consideration concerning legal transactions referred to in the report was not unduly high."

The members of the Audit Committee and the members of the Supervisory Board were provided in each case with the documentation relating to the annual financial statements, including the dependent company report, and the audit reports prepared by the auditors in good time for their meetings on February 20, 2014 and February 21, 2014 respectively.

The auditors reported extensively at both meetings on the material findings of their audit and were available to provide additional information.

Taking into consideration the audit reports and the discussion with the auditors as well as their own conclusions, the Audit Committee prepared the documents for our own examination of the consolidated financial statements, the annual financial statements of Volkswagen AG, the combined management report and the dependent company report and reported on these at the Supervisory Board meeting on February 21, 2014. Following this, the Audit Committee recommended that we approve the annual financial statements. We examined the documents in depth in the knowledge and on the basis of the report by the Audit Committee and the audit report as well as in talks and discussions with the auditors. We came to the conclusion that they are due and proper and that the assessment of the position of the Company and the Group presented by the Board of Management in the management report corresponds to the assessment by the Supervisory Board. We therefore concurred with the auditors' findings and approved the annual financial statements prepared by the Board of Management and the consolidated financial statements at our meeting on February 21, 2014. The annual financial statements are thus adopted. Our examination of the dependent company report did not result in any objections to the concluding declaration by the Board of Management in the dependent company report. We reviewed the proposal on the appropriation of net profit submitted by the Board of Management, taking into account in particular the interests of the Company and its shareholders, and endorsed the proposal.

Our thanks and appreciation go to the members of the Board of Management, the Works Council, the management and all the employees of Volkswagen AG and its affiliated companies for their work in 2013. Their collective hard work and commitment helped the Volkswagen Group to record a strong performance in a challenging market environment and to make substantial progress towards achieving the goals set out in its Strategy 2018.

Wolfsburg, February 21, 2014



Prof. Dr. Ferdinand K. Piëch  
Chairman of the Supervisory Board

# *Letter to our Shareholders*

*Dear Shareholders,*

What does growth mean to you? Of course, the automotive industry primarily measures growth in terms of increasing unit sales, rising revenue and a strong financial performance. In this respect, we succeeded in keeping the Volkswagen Group on a growth path in fiscal year 2013, despite the difficult economic environment.

With 9.73 million vehicles delivered, sales revenue of €197.0 billion and an operating profit of €11.7 billion, we met and even exceeded our goals for 2013. You – our Company’s owners – naturally also profit from this growth, not least through a significantly higher proposed dividend of €4.00 per ordinary share and €4.06 per preferred share.

For the Volkswagen Group, though, growth is not measured solely on the basis of unit sales or financial performance indicators. By implementing our Strategy 2018, we aim to also grow qualitatively in every respect and in all areas of the Company. This means that our goal is to become better and better, more efficient, more environmentally friendly and even more customer-centric – from development through production down to sales.

2013 was a growth year for your Company in this sense as well. One of the highlights was the targeted expansion of our production network, with seven new plants in China, Mexico and Russia. In terms of “sustainable mobility”, we became the first automaker to commit to the goal of cutting the CO<sub>2</sub> emissions of our European new vehicle fleet to 95 g/km by 2020. We have already made significant progress towards this goal, coming in under the 130 g/km mark for the first time in the past year. We clearly underscored our bid for technological leadership in e-mobility with the e-up!, the e-Golf, the Audi A3 e-tron and the Porsche Panamera S E-Hybrid. Our modular toolkits are the foundation for this – in 2014, we will build around two million Group vehicles using the Modular Transverse Toolkit alone, easily twice as many as in 2013. And finally, our Commercial Vehicles segment is also making considerable progress. Scania, MAN and Volkswagen Commercial Vehicles are growing closer together and will make positive headlines in the coming years.



*“The Volkswagen Group  
once again became a great  
deal more innovative,  
more international and more  
competitive last year.”*

---

MARTIN WINTERKORN

Overall, the Volkswagen Group once again became a great deal more innovative, more international and more competitive last year. In other words, we grew both quantitatively and qualitatively. We are proud of this – and I would like to thank our more than 570,000 employees for their tremendous dedication and the hard work behind these successes.

Without a doubt, the economy, the competition and the markets will again demand much from us this year. Nevertheless, I am convinced that, together, we will also overcome the next obstacles on our road to becoming the world's best automotive group. The Volkswagen Group's strengths are plain to see: we have a unique brand and model portfolio, and an extremely successful Financial Services segment. We are well positioned around the world and have strong, rock-solid finances to build on. And above all, we have technological expertise and innovative power that is unparalleled in our industry. We can and will continue to keep the Volkswagen Group on a strong and healthy growth path on this basis. To do so, we are counting not least on your faith in us. This is why I am asking you, as Volkswagen's shareholders, to continue to follow and support your Company on its challenging, but rewarding journey to the top.

Sincerely,

A handwritten signature in blue ink that reads "Martin Winterkorn". The signature is written in a cursive, flowing style.

Prof. Dr. Martin Winterkorn



STRATEGY  
*The Board of Management*







# The Board of Management

OF VOLKSWAGEN AKTIENGESELLSCHAFT

(from left to right)

Dr. h.c. Leif Östling  
*Commercial Vehicles*

—  
Christian Klingler  
*Sales and Marketing*

—  
Prof. Rupert Stadler  
*Chairman of the Board of Management of AUDI AG*

—  
Dr.-Ing. E.h. Michael Macht  
*Production*

—  
Prof. Dr. rer. pol. Horst Neumann  
*Human Resources and Organization*

—  
Prof. Dr. rer. pol. Dr.-Ing. E.h. Jochem Heizmann  
*China*

—  
Hans Dieter Pötsch  
*Finance and Controlling*

—  
Prof. Dr. Dr. h.c. mult. Martin Winterkorn  
*Chairman of the Board of Management  
of Volkswagen Aktiengesellschaft  
Research and Development*

—  
Dr. rer. pol. h.c. Francisco Javier Garcia Sanz  
*Procurement*

Curriculum Vitae

[www.volkswagenag.com](http://www.volkswagenag.com) > The Group > Senior Management



# 2

## *Divisions*

UNIT SALES BY MARKET, 2013 VS. 2012 (in percent)

+0.5

NORTH AMERICA

-8.1

SOUTH AMERICA

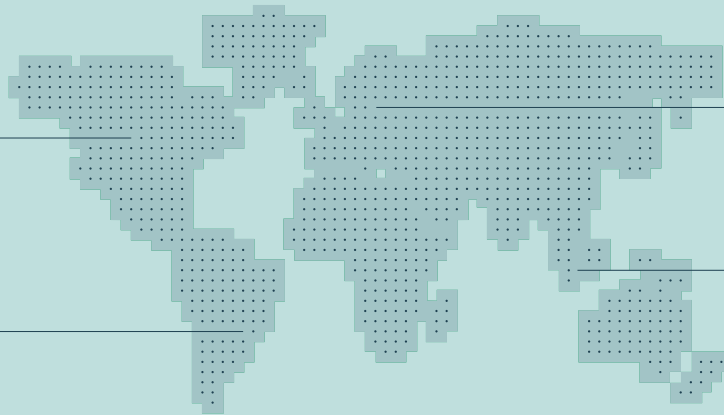

+0.7

EUROPE/  
OTHER MARKETS

+13.7

ASIA-PACIFIC

# 2

.....

**DIVISIONS**

.....

21 Brands and Business Fields .....  
24 Volkswagen Passenger Cars .....  
26 Audi .....  
28 ŠKODA .....  
30 SEAT .....  
32 Bentley .....  
34 Porsche .....  
36 Volkswagen Commercial Vehicles .....  
38 Scania .....  
40 MAN .....  
42 Volkswagen Group China .....  
44 Volkswagen Financial Services .....



# Brands and Business Fields

Successful business growth despite difficult conditions.  
Product initiatives continued.

## GROUP STRUCTURE

The Volkswagen Group consists of two divisions: the Automotive Division and the Financial Services Division. The former has comprised both the Passenger Cars Business Area and the Commercial Vehicles/Power Engineering Business Area since January 1, 2013. We report the Passenger Cars segment and the reconciliation in the Passenger Cars Business Area. The light commercial vehicles business and the trucks and buses businesses have been presented under the Commercial Vehicles segment since January 1, 2013. We report on the Commercial Vehicles and Power Engineering segments under the Commercial Vehicles/Power Engineering Business Area. The prior-year figures were adjusted accordingly. The activities of the Automotive Division comprise the development of vehicles and engines, the production and sale of passenger cars, light commercial vehicles, trucks, buses and motorcycles, as well as the genuine parts, large-bore diesel engines, turbomachinery, special gear units, propulsion components and testing systems businesses. The Ducati brand, which was acquired in 2012, is allocated to the Audi brand and is thus presented in the Passenger Cars reporting segment. The Financial Services Division, which corresponds to the Financial Services segment, combines dealer and customer financing, leasing, banking and insurance activities, fleet management and mobility offerings.

## VOLKSWAGEN GROUP

Division	Automotive									Financial Services	
Brand/ Business Field	Volkswagen Passenger Cars	Audi	ŠKODA	SEAT	Bentley	Porsche	Volkswagen Commercial Vehicles	Scania	MAN	Other	Dealer and customer financing Leasing Direct bank Insurance Fleet business Mobility offerings

In this chapter, we present the key volume and financial data relating to the Group brands and to Volkswagen Financial Services. In light of the ongoing positive development of our business in China and the continuing growth in the importance of the Chinese market, we also report on business developments and the results of our activities in China in this chapter.

The production figures and deliveries to customers are presented by product line. Unit sales figures refer to models sold by the various brand companies, including vehicles of other Group brands. In some cases, there are marked differences between delivery figures and unit sales as a result of the positive growth of our business in China.

In addition, we explain unit sales and sales revenue in our markets: Europe/Other markets, North America, South America and Asia-Pacific.

#### KEY FIGURES BY MARKET

The Volkswagen Group continued on its successful trajectory in 2013 despite challenging markets. Unit sales increased by 4.1% to 9.7 million vehicles and sales revenue rose by 2.2% to €197.0 billion.

In the Europe/Other markets region, the Group's unit sales were up slightly year-on-year at 4.2 million vehicles in the reporting period (+0.7%). Sales revenue also rose by 1.5% to €117.1 billion.

In North America, the Group recorded a slight increase in unit sales, by 0.5% to 0.9 million units. At €27.4 billion, sales revenue was up by 9.5% on 2012. The initial full-year integration of Porsche more than offset the negative effects due to exchange rates.

In the highly competitive South American region, sales declined by 8.1% to 1.0 million vehicles in 2013. Sales revenue slipped by 4.5% to €17.5 billion due to lower volumes and adverse exchange rate movements.

The Asia-Pacific markets recorded ongoing high demand for Group models. Including the Chinese joint ventures, we sold 3.6 million vehicles there during the reporting period, 13.7% more than in 2012. Sales revenue rose by 3.2% to €35.0 billion; this was impacted by negative exchange rate effects. These figures do not include the sales revenue generated by our Chinese joint ventures, since these are accounted for using the equity method.

DIVISIONS  
Brands and Business Fields

KEY FIGURES BY BRAND AND BUSINESS FIELD<sup>1</sup>

Thousand vehicles/€ million	VEHICLE SALES		SALES REVENUE		SALES TO THIRD PARTIES		OPERATING PROFIT	
	2013	2012	2013	2012	2013	2012	2013	2012 <sup>2</sup>
Volkswagen Passenger Cars	4,704	4,850	99,397	103,942	71,426	77,110	2,894	3,643
Audi	1,349	1,299	49,880	48,771	34,560	33,461	5,030	5,365
ŠKODA	719	727	10,324	10,438	5,379	5,633	522	712
SEAT	459	429	6,874	6,485	3,044	2,785	-152	-156
Bentley	11	9	1,679	1,453	1,122	1,274	168	100
Porsche <sup>3</sup>	155	62	14,326	5,879	13,175	5,442	2,579	943
Volkswagen Commercial Vehicles	436	437	9,370	9,450	4,651	4,920	448	421
Scania <sup>3</sup>	80	67	10,360	9,314	10,360	9,314	974	930
MAN <sup>3</sup>	140	134	15,861	15,999	15,744	15,900	319	813
VW China <sup>4</sup>	3,038	2,609	-	-	-	-	-	-
Other	-1,364	-1,279	-40,047	-36,929	20,227	20,516	-2,725 <sup>5</sup>	-2,682 <sup>5</sup>
Volkswagen Financial Services	-	-	18,983	17,872	17,319	16,322	1,614	1,408
<b>Volkswagen Group</b>	<b>9,728</b>	<b>9,345</b>	<b>197,007</b>	<b>192,676</b>	<b>197,007</b>	<b>192,676</b>	<b>11,671</b>	<b>11,498</b>
Automotive Division	9,728	9,345	175,003	172,822	176,914	174,525	9,807	9,913
of which: Passenger Cars Business Area <sup>6</sup>	9,071	8,706	140,077	138,571	147,107	145,122	9,013	8,968
Commercial Vehicles/Power Engineering Business Area <sup>6</sup>	657	639	34,927	34,251	29,808	29,403	794	945
Financial Services Division	-	-	22,004	19,854	20,093	18,151	1,863	1,585

1 All figures shown are rounded, so minor discrepancies may arise from addition of these amounts.

2 Prior-year figures adjusted to reflect application of IAS 19R.

3 Including financial services; Porsche as from August 1, 2012.

4 The sales revenue and operating profit of the joint venture companies in China are not included in the figures for the Group. The Chinese companies are accounted for using the equity method and recorded a proportionate operating profit of €4,296 million (€3,678 million).

5 Mainly intragroup items recognized in profit or loss, in particular from the elimination of intercompany profits; the figure includes depreciation and amortization of identifiable assets as part of the purchase price allocation for Scania, Porsche Holding Salzburg, MAN and Porsche.

6 Volkswagen Commercial Vehicles has been reported within the Automotive Division under Commercial Vehicles since January 1, 2013; the prior-year figures have been adjusted.

KEY FIGURES BY MARKET<sup>1</sup>

Thousand vehicles/€ million	VEHICLE SALES		SALES REVENUE	
	2013	2012	2013	2012
Europe/Other markets	4,209	4,179	117,062	115,384
North America	901	896	27,434	25,046
South America	987	1,075	17,495	18,311
Asia-Pacific <sup>2</sup>	3,632	3,194	35,016	33,936
<b>Volkswagen Group<sup>2</sup></b>	<b>9,728</b>	<b>9,345</b>	<b>197,007</b>	<b>192,676</b>

1 All figures shown are rounded, so minor discrepancies may arise from addition of these amounts.

2 The sales revenue of the joint venture companies in China is not included in the figures for the Group and the Asia-Pacific market.



The Volkswagen Passenger Cars brand can look back on a positive performance in fiscal year 2013. The new Golf was an outstanding success that strengthened the brand's competitive position. And the e-up! launched the brand into the era of e-mobility.

#### BUSINESS DEVELOPMENT

At the beginning of 2013, the Volkswagen Passenger Cars brand unveiled the XL1, the most economical series automobile in the world, at the Geneva Motor Show. The two-seater, which features a plug-in hybrid system, is the Group's technological spearhead and consumes just 0.9 l of diesel per 100 km. The brand also presented the Golf estate and the sporty Golf GTI and Golf GTD models. The e-up!, the Volkswagen Group's first pure-play electric drive vehicle, made its debut at the IAA in Frankfurt am Main. The pure-play electric version of the Golf was presented at the same time; production is scheduled to start at the beginning 2014. In addition, the close-to-production Golf Sportsvan study also premiered; it will round off the Golf family from mid-2014. The world premiere of the new Golf R – the series' flagship model – completed the showing at the IAA.

The Volkswagen Passenger Cars brand delivered 5.9 million vehicles last year, recording growth of 3.4% compared with 2012 despite challenging market conditions. This was primarily due to the 16.6% increase in sales in China, the largest single market. Demand in Mexico also developed positively, growing by 16.2%.

Unit sales by the Volkswagen Passenger Cars brand in the reporting period declined by 3.0% to 4.7 million vehicles. Demand for the new Golf, the up! and the new Beetle Cabrio was extremely encouraging. The difference between deliveries and unit sales is attributable to the fact that the vehicle-producing joint ventures in China are not counted as Volkswagen Passenger Cars brand companies.

At 5.9 million vehicles, the Volkswagen Passenger Cars brand produced 2.6% more cars than in 2012. Alongside the locations in China, the plants in Wolfsburg, Pune (India) and Kaluga (Russia) recorded the highest growth rates. Production of the new Golf began in China; in Puebla, Mexico, this successful model has been rolling off the production line there since January 2014 for the North American market.

#### SALES REVENUE AND EARNINGS

The Volkswagen Passenger Cars brand generated sales revenue of €99.4 billion in 2013, falling 4.4% short of the prior-year figure as a result of exchange rate and volume-related factors. Operating profit, which declined by 20.6% to €2.9 billion, was impacted in particular by the lower unit sales and upfront investments in new technologies. The operating return on sales was 2.9% (3.5%).

# 5.9 million

---

*Vehicles produced*



PRODUCTION

Units	2013	2012
Jetta/Bora	871,413	866,678
Golf	824,629	825,591
Lavida/Sagitar	727,291	480,927
Polo	725,291	726,784
Passat/CC	651,027	705,435
Tiguan	472,958	453,081
Santana/Magotan	456,073	385,883
Gol	454,725	502,486
Fox	164,763	197,823
up!	143,188	141,515
Touran	135,382	152,683
Beetle	109,517	107,939
Touareg	70,861	77,635
Sharan	40,159	48,399
Suran	39,674	37,602
Scirocco	23,400	33,620
Eos	7,651	11,138
Phaeton	5,812	10,190
Parati	–	6,380
	<b>5,923,814</b>	<b>5,771,789</b>

VOLKSWAGEN PASSENGER CARS BRAND

	2013	2012*	%
Deliveries (thousand units)	5,932	5,738	+ 3.4
Vehicle sales	4,704	4,850	– 3.0
Production	5,924	5,772	+ 2.6
Sales revenue (€ million)	99,397	103,942	– 4.4
Operating profit	2,894	3,643	– 20.6
as % of sales revenue	2.9	3.5	

\* Prior-year figures adjusted to reflect application of IAS 19R.

# Golf Sportsvan



DELIVERIES BY MARKET  
in percent

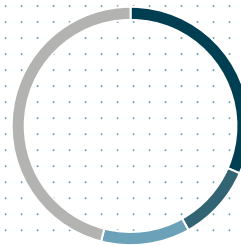

Europe/Remaining markets 31.5  
North America 10.4  
South America 12.1  
Asia-Pacific 46.0

**i** FURTHER INFORMATION [www.volkswagen.com](http://www.volkswagen.com)



Audi delivered a record number of vehicles in 2013, exceeding its volume target of 1.5 million units originally set for 2015 two years ahead of schedule. 2013 was also a year of expansion for the international production structures. The new production facilities further extend the brand's competitive position in the premium segment worldwide.

#### BUSINESS DEVELOPMENT

In fiscal year 2013, the Audi brand expanded its global production network in addition to its ongoing expansion of the German sites in Ingolstadt and Neckarsulm, thereby laying the groundwork for further growth. For example, the existing engine and assembly plant in Győr, Hungary, was expanded into an automobile production facility with an end-to-end process chain. The new A3 saloon has been produced there since mid-2013 – the first model to be completely produced at this location; series production of the new A3 Cabriolet began there in October 2013. A new FAW-Volkswagen joint venture vehicle plant opened in Foshan, China, kicking off local production of the A3 saloon and the A3 Sportback.

In terms of products, the past fiscal year was dominated by the successive expansion of the A3 family. The A3 saloon has launched Audi into the world's fastest growing market segment: the compact saloon class. The Audi brand also added to its range of especially sporty S and RS models with a large number of product innovations – such as the SQ5, RS 6 Avant and RS 7 Sportback models. The Audi brand delivered 1.6 million vehicles in the reporting period, exceeding the record 2012 figure by 8.3%. This means that, in 2013, Audi met its target set for 2015 of 1.5 million Audi deliveries per year ahead of schedule. The Asia-Pacific (+20.9%) and North America (+12.7%) regions in particular grew at a fast pace.

Unit sales by the Audi brand in 2013 amounted to 1.3 million vehicles, 3.9% more than in the previous year; in addition, the FAW-Volkswagen Chinese joint venture sold a further 411 thousand Audi vehicles. The A3 family and the Q3, Q5 and Q7 SUV models recorded particularly high growth in demand. Automobili Lamborghini S.p.A. sold 2,111 vehicles (2,120 vehicles) in its fiftieth year.

At 1.6 million vehicles, 9.5% more Audi models were produced last year than in 2012. Lamborghini produced 2,122 vehicles (2,197 vehicles).

#### SALES REVENUE AND EARNINGS

At €49.9 billion, the Audi brand's sales revenue in the reporting period exceeded the prior-year figure by 2.3% despite adverse currency effects. The decline in operating profit from €5.4 billion to €5.0 billion is primarily attributable to upfront investments in new products and new technologies, the impact of the systematic expansion of the international production network and the challenging market environment at many locations. The brand generated an operating return on sales of 10.1% (11.0%). The financial key performance indicators for the Lamborghini and Ducati brands are included in the financial figures for the Audi brand.

*1,578 thousand*

*Deliveries to customers in the year 2013*

PRODUCTION

Units	2013	2012
<b>Audi</b>		
A4	338,449	329,759
A6	288,739	284,888
Q5	231,435	209,799
A3	221,097	164,666
Q3	152,163	106,918
A1	120,520	123,111
A5	98,207	103,357
Q7	63,400	54,558
A8	39,717	35,932
A7	30,799	28,950
TT	18,358	21,880
R8	2,500	2,241
	<b>1,605,384</b>	<b>1,466,059</b>
<b>Lamborghini</b>		
Aventador Coupé	710	958
Aventador Roadster	403	18
Gallardo Coupé	653	822
Gallardo Spyder	280	399
Huracán Coupé	76	–
	<b>2,122</b>	<b>2,197</b>
<b>Audi brand</b>	<b>1,607,506</b>	<b>1,468,256</b>
Ducati, motorcycles*	45,018	15,734

\* Starting in July 2012.

# A3 saloon



AUDI BRAND

	2013	2012*	%
Deliveries (thousand units)	1,578	1,457	+ 8.3
Vehicle sales	1,349	1,299	+ 3.9
Production	1,608	1,468	+ 9.5
Sales revenue (€ million)	49,880	48,771	+ 2.3
Operating profit	5,030	5,365	–6.2
as % of sales revenue	10.1	11.0	

\* Prior-year figures adjusted to reflect application of IAS 19R.

DELIVERIES BY MARKET  
in percent

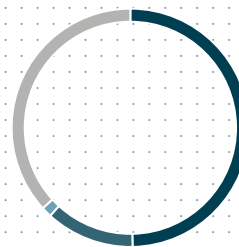

Europe/Remaining markets 49.7  
North America 12.1  
South America 1.4  
Asia-Pacific 36.8

**i** FURTHER INFORMATION [www.audi.com](http://www.audi.com)



The ŠKODA brand continued the largest model rollout in its history in 2013, launching eight new models or model variants. The Rapid Spaceback is its first model in the compact hatchback segment.

#### BUSINESS DEVELOPMENT

2013 was a transition year for the ŠKODA brand as it vigorously continued its model initiative. The third generation of the Octavia, available as a saloon and an estate, met with an extremely positive reception from trade press and the public. The new edition of the brand's bestselling model offers many clever little details. The Octavia RS, the sporty version, rounds off the family. At mid-year, the revamped Superb – the brand's flagship model – arrived in saloon and estate model versions at dealerships. The Rapid saloon unveiled to the European market in the previous year was joined by the sporty Rapid Spaceback, ŠKODA's first hatchback in the compact class; both its rear seating and boot space offer superior spaciousness. The compact Yeti SUV model was revamped and is now available in two editions – the Outdoor and the City. In China, the launch of the Rapid notchback saloon represented an important addition to the model portfolio in the reporting period.

The ŠKODA brand delivered 921 thousand vehicles worldwide, down 2.0% year-on-year. The switch to new models, in particular for the Octavia, and the strained situation in many markets depressed sales in the first half of 2013 in particular. By contrast, the brand increased sales in the second half of the year, ending the year with the best December in the company's history.

At 719 thousand vehicles, unit sales for the ŠKODA brand were down 1.1% year-on-year. Demand was high for the Rapid and Citigo models, which were not affected by the model start-ups. The difference between figures for deliveries and unit sales is mainly due to the fact that the vehicle-producing joint ventures in China are not counted as ŠKODA brand companies.

In 2013, the ŠKODA brand produced 932 thousand units worldwide, only slightly lower than in the previous year (943 thousand units). The main Mladá Boleslav production facility was comprehensively expanded and modernized for the production of the Rapid and Octavia model series.

#### SALES REVENUE AND EARNINGS

The ŠKODA brand's sales revenue amounted to €10.3 billion in 2013, down 1.1% on the previous year. Negative volume-related and mix effects and exchange rate factors were the reason for the decline in operating profit from €712 million to €522 million. The operating return on sales was 5.1%, compared with 6.8% in the previous year.

**€10.3 billion**

---

*Sales revenue in 2013*

PRODUCTION

Units	2013	2012
Octavia	356,471	406,360
Fabia	196,597	255,025
Rapid	124,112	8,292
Superb	96,226	106,847
Yeti	84,265	90,952
Citigo	42,971	36,687
Roomster	31,425	39,249
	<b>932,067</b>	<b>943,412</b>

ŠKODA BRAND

	2013	2012	%
Deliveries (thousand units)	921	939	-2.0
Vehicle sales	719	727	-1.1
Production	932	943	-1.2
Sales revenue (€ million)	10,324	10,438	-1.1
Operating profit	522	712	-26.7
as % of sales revenue	5.1	6.8	

# Octavia Combi

DELIVERIES BY MARKET  
in percent

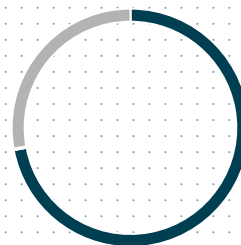

Europe/Remaining markets 72.0  
North America 0.0  
South America 0.2  
Asia-Pacific 27.8

**i** FURTHER INFORMATION [www.skoda-auto.com](http://www.skoda-auto.com)



Spanish brand SEAT drove forward its model rollout in 2013 and further expanded the Leon family. The Leon ST is the brand's first representative in the compact estate segment. The young model range helped the brand lift its sales figures.

#### BUSINESS DEVELOPMENT

SEAT celebrated two anniversaries in 2013: the first SEAT rolled off the production line in 1953, or 60 years ago. In addition, the plant in Martorell, Spain, celebrated the twentieth anniversary of its opening. More than 8 million vehicles representing 32 models have been manufactured here since then.

The product rollout launched in the previous year continued in 2013; the new Ibiza Cupra was the first. During the year, SEAT expanded its successful Leon series to include the Leon SC, a three-door version, and the Leon ST – the brand's first compact estate and also the lightest estate in its class. The Leon is becoming the second key pillar of the brand alongside the Ibiza.

The SEAT brand increased its deliveries to customers by 10.6% to 355 thousand vehicles in fiscal year 2013, generating the highest sales figure in five years. The Leon family in particular spurred sales growth, mainly concentrated in Germany (+20.3%), the United Kingdom (+17.0%) and Spain (+6.0%).

Unit sales for the SEAT brand rose by 6.9% to 459 thousand vehicles in the reporting period. This figure includes the Q3 manufactured for Audi.

SEAT produced 353 thousand vehicles in 2013, exceeding the prior-year figure by 9.8%. The last Exeo rolled off the production line in July 2013; this model had been produced for five years.

#### SALES REVENUE AND EARNINGS

The SEAT brand generated sales revenue of €6.9 billion in fiscal 2013, up 6.0% year-on-year. The operating result narrowed from €-156 million in the previous year to €-152 million. Volume and mix improvements as well as lower material costs were positive factors, while launch costs for the new models and restructuring costs had an offsetting effect. The brand recorded an operating return on sales of -2.2% (-2.4%).

# 10.6%

---

*Increase in deliveries*

PRODUCTION

Units	2013	2012
Ibiza	145,041	160,887
Leon	114,568	71,295
Altea/Toledo	43,055	32,478
Mii	25,489	26,409
Alhambra	19,990	19,393
Exeo	4,681	10,854
	<b>352,824</b>	<b>321,316</b>

SEAT BRAND

	2013	2012	%
Deliveries (thousand units)	355	321	+ 10.6
Vehicle sales	459	429	+ 6.9
Production	353	321	+ 9.8
Sales revenue (€ million)	6,874	6,485	+ 6.0
Operating result	-152	-156	+ 2.9
as % of sales revenue	-2.2	-2.4	

# Leon SC

DELIVERIES BY MARKET  
in percent

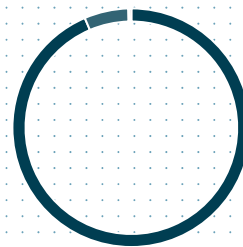

Europe/Remaining markets 93.6  
North America 6.0  
South America 0.1  
Asia-Pacific 0.3

**i** FURTHER INFORMATION [www.seat.com](http://www.seat.com)



The Bentley brand continued on its successful course in 2013 and posted a new sales record. It launched the new Flying Spur.

#### BUSINESS DEVELOPMENT

The Continental GTC Speed Convertible celebrated its world premiere in 2013. Its top speed of 325 km/h makes it the fastest convertible in the world. Bentley had launched the Continental GT Speed coupé as the sporty top-of-the-range model in the series in the previous year. The second generation of the Flying Spur – the strongest and fastest saloon in Bentley history – made its debut in the reporting period.

For the fourth year in succession, Bentley recorded double-digit volume growth. Deliveries increased by 18.9% year-on-year to 10,120 vehicles. The US market, which grew by 28.0% to 2,963 units, was once again the largest single market for Bentley, followed by China with 2,126 units. The brand was also extremely successful in the Europe (+17.3%) and Middle East (+48.4%) regions.

Bentley sold 10,564 vehicles in the reporting period, a 15.0% increase year-on-year. The Continental GT and Flying Spur models were extremely well received by customers.

The Bentley brand produced 10,876 vehicles in 2013; this corresponds to an increase of 19.4% compared with the prior-year period.

#### SALES REVENUE AND EARNINGS

The Bentley brand generated sales revenue of €1.7 billion in the period from January to December 2013, exceeding the prior-year figure by 15.5%. Higher volumes, favorable exchange rates and mix effects lifted operating profit by 66.9% to €168 million. The operating return on sales increased to 10.0% (6.9%).

# 10.0%

---

*Operating return on sales in 2013*



PRODUCTION

Units	2013	2012
Continental GT Coupé	3,602	3,536
Continental GT Convertible	2,197	2,638
Flying Spur	3,960	1,764
Mulsanne	1,117	1,169
	<b>10,876</b>	<b>9,107</b>

BENTLEY BRAND

	2013	2012	%
Deliveries (units)	10,120	8,510	+ 18.9
Vehicle sales	10,564	9,186	+ 15.0
Production	10,876	9,107	+ 19.4
Sales revenue (€ million)	1,679	1,453	+ 15.5
Operating profit	168	100	+ 66.9
as % of sales revenue	10.0	6.9	

# Flying Spur

DELIVERIES BY MARKET  
in percent

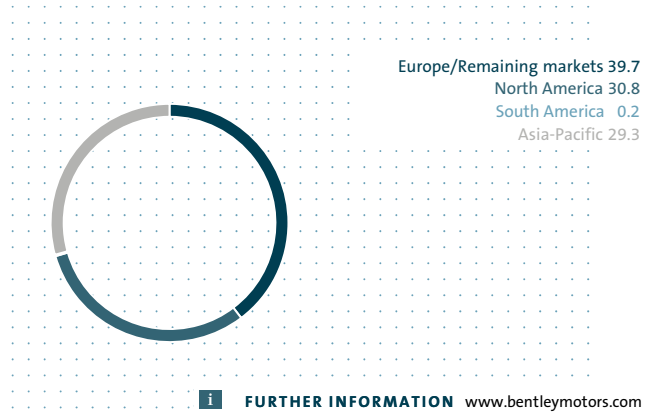
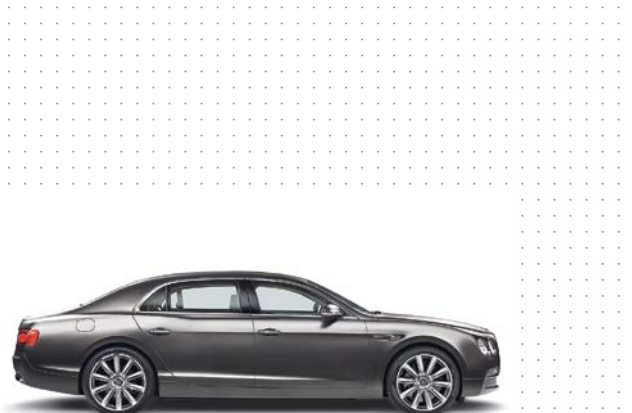

**i** FURTHER INFORMATION [www.bentleymotors.com](http://www.bentleymotors.com)



The Porsche brand can look back on a very successful 2013. Among other things, it made extensive investments to restructure and expand its plants. Porsche aims to appeal to new customers with the Macan. The brand also celebrated a special anniversary last year: 50 years of the Porsche 911.

#### BUSINESS DEVELOPMENT

In 2013, the Porsche brand systematically pursued its projects to safeguard its future: it modernized its main production facility in Stuttgart and expanded the development center in Weissach. In addition, it significantly expanded the Leipzig plant, where Porsche's fifth model series – the Macan – is being produced. At the same time, Porsche's next generation Panamera increased the attractiveness of the product range. The focus of public attention was on the new Panamera S E-Hybrid – the world's first plug-in hybrid in the luxury class. In addition, the brand unveiled the limited-edition 918 Spyder super sports car, which also boasts an innovative plug-in hybrid drive.

With over 820,000 manufactured vehicles, the Porsche 911 is the world's most successful sports car. The brand's emotional linchpin marked its 50th anniversary in 2013. Porsche presented a new edition of the high-performance 911 GT3 – a racetrack-worthy series sports car – in addition to the Turbo and Turbo S.

The key figures presented in this chapter comprise Porsche's Automotive and Financial Services businesses. The prior-year figures relate to the period since Porsche was consolidated in the Volkswagen Group, i.e. from August 1, 2012.

Porsche delivered 162 thousand sports cars to customers in the past fiscal year. The USA remained the largest single market, where 42 thousand customers bought a Porsche model. It was followed by China, where sales figures were also encouraging (37 thousand vehicles). Porsche delivered 21 thousand models to customers in its home market of Germany.

The Porsche brand produced 166 thousand vehicles in the reporting period. Production of the new series began at year-end – like the Cayenne and the Panamera, the Macan is also produced at the Leipzig plant.

#### SALES REVENUE AND EARNINGS

The Porsche brand recorded a highly successful fiscal year 2013. Sales revenue amounted to €14.3 billion (€5.9 billion). Operating profit was €2.6 billion (€0.9 billion), while the operating return on sales was 18.0% (16.0%).

# 911

---

*50 years of a style icon*

PRODUCTION

Units	2013	2012*
Cayenne	81,916	36,664
911 Coupé/Cabriolet	29,751	11,409
Boxster/Cayman	28,996	6,839
Panamera	24,798	8,772
Macan	312	–
918 Spyder	35	–
	<b>165,808</b>	<b>63,684</b>

PORSCHE BRAND

	2013	2012*
Deliveries (thousand units)	162	60
Vehicle sales	155	62
Production	166	64
Sales revenue (€ million)	14,326	5,879
Operating profit	2,579	943
as % of sales revenue	18.0	16.0

\* August 1 to December 31, 2012. Prior-year figures adjusted to reflect application of IAS 19R.

# 911

DELIVERIES BY MARKET  
in percent

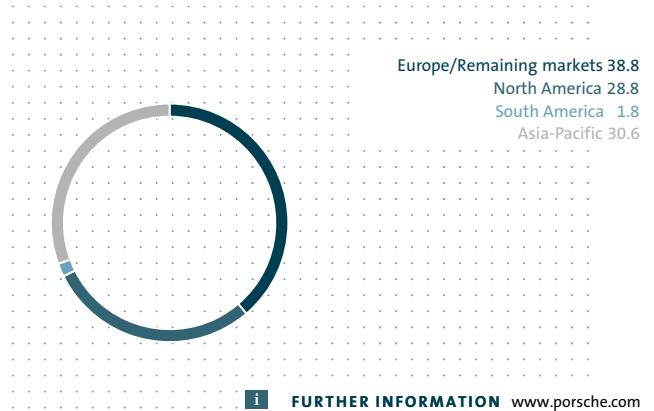
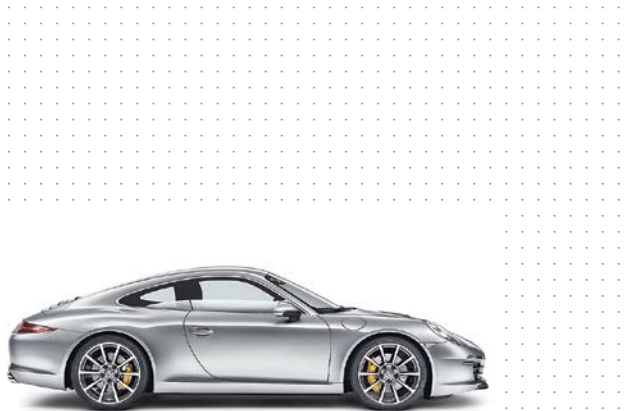

**i** FURTHER INFORMATION [www.porsche.com](http://www.porsche.com)



**Commercial  
Vehicles**

Volkswagen Commercial Vehicles recorded excellent sales figures in 2013 despite declining European markets, slightly exceeding the prior-year volume. This was driven in particular by growth in the Americas and the Asia-Pacific region.

**BUSINESS DEVELOPMENT**

In the past year, Volkswagen Commercial Vehicles unveiled a large number of new models in its product portfolio. The brand presented the Amarok Single Cab as a three-way tipper with numerous features and selectable all-wheel drive at the International Trade Fair for Construction Machinery. The new special edition Amarok Dark Label made its debut at the IAA in Frankfurt am Main. The model's dark attachments highlight its sporty, elegant features. The Caddy BlueMotion, the most economical Caddy ever made, also premiered there. In 2013, the brand celebrated the 9 million milestone for vehicles manufactured at the main production facility in Hanover since the plant opened in 1956. It also celebrated the 25th anniversary of the California camper. Volkswagen Commercial Vehicles marked this occasion with an attractive special edition featuring extensive equipment as a standard.

At 552 thousand vehicles delivered to customers worldwide, Volkswagen Commercial Vehicles slightly exceeded the prior-year figure by 0.3% in the reporting period. The brand recorded an encouraging increase in demand especially in North and South America and the Asia-Pacific region. Demand increased for the Saveiro and Amarok models. Volkswagen Commercial Vehicles intends to become more global, making it less dependent on regional market fluctuations.

At 436 thousand (437 thousand) vehicles, unit sales to the dealer organization in fiscal year 2013 were on a level with the previous year.

The Volkswagen Commercial Vehicles brand increased its production by 5.0% to a total of 511 thousand vehicles last year. The Crafter produced at a contractual partner's plants is not included in these figures. The Caravelle/Multivan, Transporter and Amarok models produced at the main production facility in Hanover amounted to 153 thousand (150 thousand) units. The Poznan location produced 170 thousand (162 thousand) Caddy and T5 models. Production of the Volkswagen Commercial Vehicles brand's most successful model in Brazil ended with a limited special edition of the Volkswagen T2.

**SALES REVENUE AND EARNINGS**

Volkswagen Commercial Vehicles' sales revenue of €9.4 billion in the reporting period was roughly on a level with the prior-year figure of €9.5 billion. Successful cost optimization measures lifted operating profit by 6.4% to €448 million. The operating return on sales rose from 4.5% in the previous year to 4.8%.

**5.0%**

---

*Increase in production in 2013*

PRODUCTION

Units	2013	2012
Caravelle/Multivan, Kombi	107,033	112,492
Saveiro	93,334	79,694
Amarok	91,739	78,633
Caddy Kombi	77,792	74,561
Caddy	71,069	70,079
Transporter	69,880	71,085
	<b>510,847</b>	<b>486,544</b>

VOLKSWAGEN COMMERCIAL VEHICLES BRAND

	2013	2012	%
Deliveries (thousand units)	552	550	+ 0.3
Vehicle sales	436	437	-0.3
Production	511	487	+ 5.0
Sales revenue (€ million)	9,370	9,450	-0.9
Operating profit	448	421	+ 6.4
as % of sales revenue	4.8	4.5	

# Amarok



DELIVERIES BY MARKET  
in percent

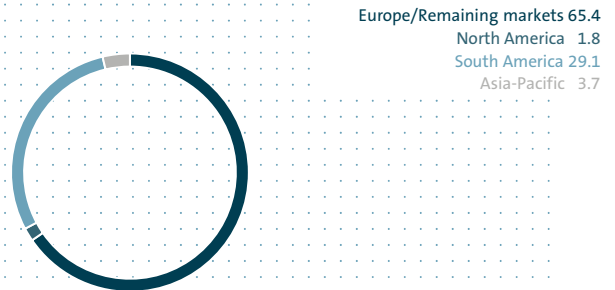

**i** FURTHER INFORMATION [www.volkswagen-commercial-vehicles.com](http://www.volkswagen-commercial-vehicles.com)



The Scania brand presented further product innovations in 2013 and rounded off its range of Euro 6 engines. It also unveiled other innovations such as new safety and driver assistance systems – while continuing to focus on individual customer solutions and cost efficiency.

#### BUSINESS DEVELOPMENT

Scania's long-term goal is to sell 120,000 trucks, 15,000 buses and 20,000 engines worldwide in 2020. To do this, the brand is systematically enhancing its services. In addition, every vehicle is tailored to meet customer-specific transportation requirements, thus improving its profitability.

In fiscal year 2013, the brand presented the new Scania Streamline, a long-distance model that drives forward its ongoing efforts to reduce fuel consumption. The Swedish commercial vehicles manufacturer also launched a V8 engine with 544 kW (730 PS) and rounded off its offering of Euro 6 engines to a total of 15. These include drivetrains that can be powered up to 100% by biodiesel or gas. In addition, it launched new and enhanced safety and driver assistance systems – one example is the Advanced Emergency Braking system. These systems increase productivity and traffic safety.

The introduction of the Euro 6 emission standard on January 1, 2014 lifted orders for trucks in Europe, in particular in the second and third quarters. Orders also rose in South America.

Scania increased its global deliveries to customers in 2013 by 19.4% year-on-year to 80 thousand vehicles. Demand in the South American (+47.9%) and Western European (+15.6%) markets was up on the previous year. Bus delivery volumes rose by 7.9% to 7 thousand (6 thousand) units. Demand also increased for the service and genuine parts business in the reporting period.

The Scania brand produced 83 thousand vehicles in 2013, 23.8% more than a year earlier. This included 7 thousand buses.

#### SALES REVENUE AND EARNINGS

The Scania brand's sales revenue rose by 11.2% to €10.4 billion in the reporting period due to volume-related factors. Nevertheless, negative exchange rate effects together with increased competition and the associated pressure on margins meant that operating profit did not record more pronounced of year-on-year growth, rising to €974 million (€930 million). In 2013, the operating return on sales for the brand was 9.4% after 10.0% in the previous year.

# 23.8%

---

*Increase in production*

PRODUCTION

Units	2013	2012
Trucks	75,957	60,647
Buses	6,897	6,283
	<b>82,854</b>	<b>66,930</b>

SCANIA BRAND

	2013	2012	%
Orders received (thousand units)	81	72	+ 12.5
Deliveries	80	67	+ 19.4
Vehicle sales	80	67	+ 19.4
Production	83	67	+ 23.8
Sales revenue (€ million)	10,360	9,314	+ 11.2
Operating profit	974	930	+ 4.7
as % of sales revenue	9.4	10.0	

# Citywide

DELIVERIES BY MARKET  
in percent

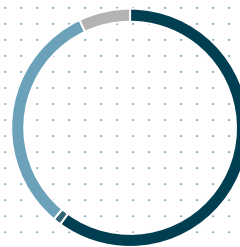

Europe/Remaining markets 60.0  
North America 1.1  
South America 31.9  
Asia-Pacific 7.0

**i** FURTHER INFORMATION [www.scania.com](http://www.scania.com)



MAN can look back on over 250 consecutive years of company history. For the supplier of trucks, buses, diesel engines, turbomachinery and special gear units, 2013 was dominated by the product changeover to the new Euro 6 emission standard in force in Europe since January 2014.

#### BUSINESS DEVELOPMENT

MAN's flexible solutions enable it to focus on individual customer and market needs. The Euro 6 emission standard was the core topic in the past fiscal year in the commercial vehicles segment: MAN celebrated world premieres of new Euro 6 engines across all of its model series. In addition, MAN and its NEOPLAN bus brand unveiled the entire bus portfolio with economical, high-performance Euro 6 engines. The Power Engineering business area introduced innovative products that were also well received. For example, an MAN steam turbine engine has been generating electricity in the world's largest solar power plant in Abu Dhabi since 2013.

The key figures presented in this chapter comprise the Trucks and Buses, Power Engineering and Financial Services businesses.

The economic environment remained difficult for the MAN brand in fiscal 2013. The European commercial vehicles market declined again significantly in the first half of 2013 due to the continuing sovereign debt crisis. There were considerable pull-forward effects in the second half of 2013 because of the new Euro 6 emission standard that came into force from January 1, 2014. MAN also benefited from higher orders in South America driven mainly by attractive financing conditions and high transportation demand. This lifted orders by 2.4% to 138 thousand vehicles. MAN delivered 140 thousand commercial vehicles to customers in the reporting period, 4.5% more than in the previous year. The sales figures include 16 thousand buses (+4.2%). The Power Engineering business area recorded an order intake of €3.9 billion in the reporting period, down 3.2% year-on-year. The continued difficult situation in the shipping industry, ongoing economic uncertainties and tougher financing conditions led to delays in awarding contracts.

The MAN brand increased production by 13.6% to 141 thousand commercial vehicles in the reporting period, 16 thousand (16 thousand) of which were buses.

#### SALES REVENUE AND EARNINGS

The MAN brand generated sales revenue of €15.9 billion in the period from January to December 2013, which was on a level with the previous year (€16.0 billion); roughly a quarter of this figure was attributable to the Power Engineering segment. MAN's operating profit, down from €813 million to €319 million, was mainly impacted in the Power Engineering area by lower volumes, tougher competitive pressure and declining revenue from the license business, and in particular by the recognition of project-specific contingency reserves. The operating return on sales was 2.0% (5.1%).

# 140 thousand

*Commercial vehicles sold in 2013*



PRODUCTION

Units	2013	2012
Trucks	125,423	108,417
Buses	15,788	15,887
	<b>141,211</b>	<b>124,304</b>

MAN BRAND

	2013	2012*	%
Orders received (thousand units)	138	135	+ 2.4
Deliveries	140	134	+ 4.5
Vehicle sales	140	134	+ 4.5
Production	141	124	+ 13.6
Sales revenue (€ million)	15,861	15,999	-0.9
Operating profit	319	813	-60.7
as % of sales revenue	2.0	5.1	

\* Prior-year figures adjusted to reflect application of IAS 19R.

TGX

DELIVERIES BY MARKET  
in percent

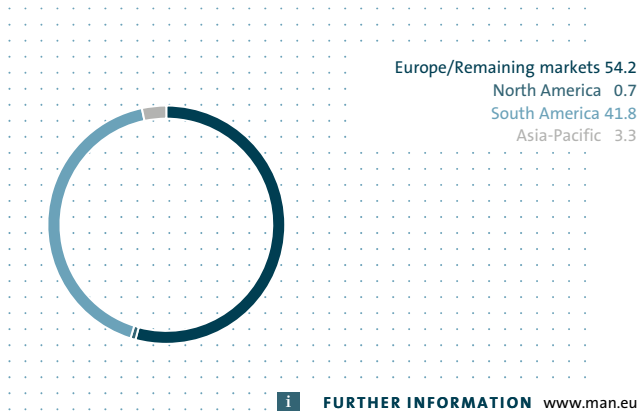

**i** FURTHER INFORMATION [www.man.eu](http://www.man.eu)

## Volkswagen Group China

The Volkswagen Group generated record highs again in China, its largest single market, and continued its new model rollout there: five new facilities opened in the reporting period alone. They meet the highest standards in terms of resource-friendly and particularly environmentally responsible production.

### BUSINESS DEVELOPMENT

In the reporting period, Volkswagen celebrated 30 years since it entered the Chinese market. The first vehicle – a Santana – rolled off the production line in Shanghai in April 1983; Chinese streets today are still full of this model. The joint venture Shanghai-Volkswagen reached a milestone in November 2013, when the ten-millionth vehicle rolled off the production line. As planned, the Volkswagen Group expanded its production network in China in the reporting period and five new facilities went into operation: Shanghai-Volkswagen played a pioneering role at the new location in Urumqi in western China – the vehicle plant is the first in a region where purchasing power is expected to rise sharply over the coming years. At the new location in Ningbo in southeastern China, production of the new ŠKODA Superb began in October 2013. With the opening of the Foshan site, our joint venture FAW-Volkswagen simultaneously launched local production of the new Golf, the first vehicle to be based on the Modular Transverse Toolkit in China. The Changchun engine plant opened in August 2013. It produces the latest generation of drivetrains for Volkswagen Passenger Cars and Audi brand models. The new components plant in Foshan also started producing components at the end of 2013. Our capacity in China now comprises a total of 17 locations for vehicle and components production. Volkswagen in China stands for both environmentally friendly mobility and sustainable growth.

The Volkswagen Group's presence in the Chinese passenger car market comprises over 60 models from its Volkswagen Passenger Cars, Volkswagen Commercial Vehicles, Audi, ŠKODA, SEAT, Lamborghini, Bentley, Porsche and Bugatti brands. The Volkswagen Group delivered 3.3 million vehicles (including imports) to customers in China in the reporting period, a 16.2% increase year-on-year that strengthened our good market position in China. The Volkswagen Lavalida, New Passat, Magotan, Jetta and Tiguan, ŠKODA Octavia, Audi A6 and Audi Q5 models were particularly popular with Chinese customers.

# 3,271 thousand

---

*Deliveries to customers in China*

## EARNINGS

Thousand units	2013	2012	%
Deliveries	3,271	2,815	+ 16.2
Vehicle sales	3,038	2,609	+ 16.4
Production	3,135	2,643	+ 18.6

€ million	2013	2012
Operating profit (100%)	9,569	8,424
Operating profit (proportionate)	4,296	3,678

In fiscal year 2013, our joint ventures sold 3.0 million locally produced vehicles, recording growth of 16.4%. In addition to established Group models and models that have been modified for the Chinese market (with a longer wheelbase, for example), the joint venture companies also produce vehicles specially designed for Chinese customers; examples of these include the Volkswagen Lavida, New Bora and Santana models.

The joint ventures produced a total of 3.1 million vehicles in the reporting period, a year-on-year increase of 18.6%. The goal is to increase Volkswagen's annual capacity in China to over four million vehicles by 2018. The joint venture companies are expected to invest a total of around €18.2 billion in new production facilities and products in China between 2014 and 2018. These investments will be financed entirely by the companies' cash flows.

The joint ventures generated a proportionate operating profit of €4.3 billion in fiscal year 2013, an increase of €0.6 billion on the prior-year figure. This positive development is due to significantly higher volumes, lower material costs and improvements in the mix.

The Chinese joint venture companies' figures are not included in Group earnings as they are accounted for using the equity method. Their profits are included solely in the Group's financial result on a proportionate basis.

## LOCAL PRODUCTION

Units	2013	2012
Volkswagen Passenger Cars	2,459,463	2,082,580
Audi	420,000	333,556
ŠKODA	255,202	226,653
<b>Total</b>	<b>3,134,665</b>	<b>2,642,789</b>

# New Lavida



## VOLKSWAGEN FINANCIAL SERVICES

AKTIENGESELLSCHAFT

Volkswagen Financial Services marked new highlights with innovative products in 2013, thereby supporting sales by the Volkswagen Group brands. It added finance offerings from MAN and Ducati to its portfolio of services and continued its international expansion.

### STRUCTURE OF VOLKSWAGEN FINANCIAL SERVICES

Volkswagen Financial Services' portfolio of services covers dealer and customer financing, leasing, banking and insurance activities, fleet management and mobility offerings. Volkswagen Financial Services AG is responsible for coordinating the Group's global financial services activities, the only exceptions being the Scania, MAN (until December 31, 2013) and Porsche brands, and the financial services business of Porsche Holding Salzburg. The principal companies in this division in Europe are Volkswagen Bank GmbH, Volkswagen Leasing GmbH and Volkswagen Versicherungsdienst GmbH. VW CREDIT, INC. operates financial services activities in North America. Volkswagen Financial Services is currently active in 49 countries, with more being added.

### BUSINESS DEVELOPMENT

Volkswagen Financial Services continued its successful course in fiscal year 2013, recording growth in three dimensions: international expansion into new markets, the extension of the product portfolio and close cooperation with Volkswagen Group brands.

The new business area Ducati Financial Services began operations in 2013. Its first step was to present attractive financial services for customers of the Ducati brand in the Italian market; shortly after, it supplemented these with offerings in the German and US markets. Further international expansion continued in Greece and Turkey.

In the area of New Mobility, Volkswagen Financial Services significantly expanded its carsharing activities. It invested in Collect Car B.V. in April 2013, which leads the Dutch carsharing market and is better known as "Greenwheels". The objective of the investment is to develop the business model and roll it out in other countries, in particular in Europe.

In 2013, Volkswagen Autoversicherung AG – a strategic partnership between Volkswagen Financial Services AG and Allianz SE – was successfully launched in the market. It offers car insurance at attractive conditions to customers of the Volkswagen Group's brands.

# 10.7 million

---

*Contracts as of December 31, 2013*

In the reporting period, Volkswagen Bank GmbH partnered with energy utility LichtBlick in connection with the launch of the e-up! in Germany. This has offered green energy – exclusively generated from renewable sources – to customers in Germany since May 2013 in addition to attractive financing options for the Volkswagen Group’s electric vehicles.

Volkswagen Financial Services AG acquired MAN Finance International GmbH as of January 1, 2014. This purchase expands Volkswagen Financial Services AG’s activities to include MAN’s financing, leasing and rental activities.

Volkswagen Financial Services companies were highly successful in 2013 in the course of their refinancing activities. A key element of the strategy is selective diversification, both in relation to the instruments used and by currency area. The main refinancing sources are money market and capital market instruments, asset-backed securities (ABS) transactions and deposits from the direct banking business.

Internationalization was a particular focus in 2013 and was driven forward by developing local financing instruments. For example, the Volkswagen Dogus joint venture in Turkey made its debut in the local capital market. In Brazil, Banco Volkswagen continued its 2012 success with a second publicly marketed transaction.

ABS issues are used to securitize loan and leasing receivables in various currency areas. Receivables amounting to €9.4 billion were securitized in 15 ABS transactions worldwide in 2013. In the first quarter of 2013, Volkswagen Financial Services AG marketed European loan receivables in the Driver Ten transaction. Following this, the Volkswagen Car Lease 17 transaction successfully placed leasing receivables on the market. As the year went on, the financial services providers expanded the ABS program internationally. The Driver France One transaction involving securitized auto loans was the first transaction successfully completed in France. Driver Australia One in Australia expanded the ABS program into a new currency area and a new continent. Australia is the seventh country after Germany, the United Kingdom, Spain, Japan, Brazil and France where Volkswagen Financial Services AG is active on the capital markets with its Driver platform. Auto loans were successfully securitized for a second time in Brazil and Japan. In the USA, VW CREDIT INC. used its established securitization programs, placing two VALET transactions using auto loans and one VALT transaction securitized with leasing receivables in the local market.

# €1.6 billion

---

*Operating profit for 2013*



The number of new finance, leasing and service/insurance contracts signed in the past fiscal year rose by 13.4% to 4.3 million. The Customer Financing/Leasing area recorded a 9.0% rise in the number of contracts to 6.9 million on December 31, 2013. The number of contracts in the Service/Insurance area also grew by 15.7% year-on-year to 3.8 million. At 10.7 million, the total number of contracts again reached a record high (+11.3%). Based on unchanged credit eligibility criteria, the share of financed or leased vehicles increased to 28.9% (27.5%) of total Group delivery volumes.

Volkswagen Bank direct was managing 1,418 thousand accounts at the end of the reporting period (1,438 thousand). The Volkswagen Financial Services Division employed 10,945 people as of the reporting date.

#### SALES REVENUE AND EARNINGS

Volkswagen Financial Services generated sales revenue of €19.0 billion in 2013, up 6.2% on the prior-year figure. Operating profit rose by 14.6% to €1.6 billion. Volume and margin improvements more than offset higher risk provisions and deteriorations in exchange rates as well as higher expenses for meeting banking regulatory requirements. As in previous years, Volkswagen Financial Services once again made a significant contribution to the Volkswagen Group's earnings.

#### VOLKSWAGEN FINANCIAL SERVICES

		2013	2012 <sup>1</sup>	%
Number of contracts	thousands	10,725	9,640	+ 11.3
Customer financing		4,946	4,551	+ 8.7
Leasing		1,983	1,808	+ 9.7
Service/Insurance		3,796	3,281	+ 15.7
Receivables from	€ million			
Customer financing		50,735	48,779	+ 4.0
Dealer financing		13,154	12,942	+ 1.6
Leasing agreements		16,181	15,476	+ 4.6
Direct banking deposits	€ million	21,285	22,004	- 3.3
Total assets	€ million	115,067	111,052	+ 3.6
Equity	€ million	11,582	11,314	+ 2.4
Liabilities <sup>2</sup>	€ million	99,465	95,630	+ 4.0
Equity ratio	%	10.1	10.2	
Return on equity before tax <sup>3</sup>	%	14.9	13.4	
Leverage <sup>4</sup>		8.6	8.5	
Operating profit	€ million	1,614	1,408	+ 14.6
Profit before tax	€ million	1,711	1,414	+ 21.0
Employees at Dec. 31		10,945	10,133	+ 8.0

1 Prior-year figures adjusted to reflect application of IAS 19R.

2 Excluding provisions and deferred tax liabilities.

3 Profit before tax as a percentage of average equity (continuing operations).

4 Liabilities as a percentage of equity.

# 3

# Group Management Report

(COMBINED MANAGEMENT REPORT OF THE VOLKSWAGEN GROUP AND VOLKSWAGEN AG)

VOLKSWAGEN GROUP CUSTOMER DELIVERIES WORLDWIDE *(in millions)*

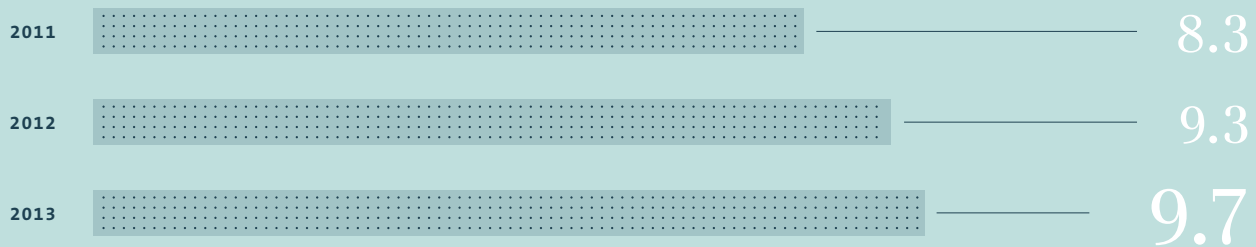



GROUP MANAGEMENT REPORT

49 Goals and Strategies

50 Internal Management System and Key Performance Indicators

52 Structure and Business Activities

54 Corporate Governance Report

60 Remuneration Report

65 Executive Bodies

69 Disclosures Required Under Takeover Law

72 Business Development

85 Shares and Bonds

94 Results of Operations, Financial Position and Net Assets

109 Volkswagen AG (condensed, in accordance with the German Commercial Code)

113 Sustainable Value Enhancement

143 Report on Expected Developments

151 Report on Risks and Opportunities

164 Prospects for 2014

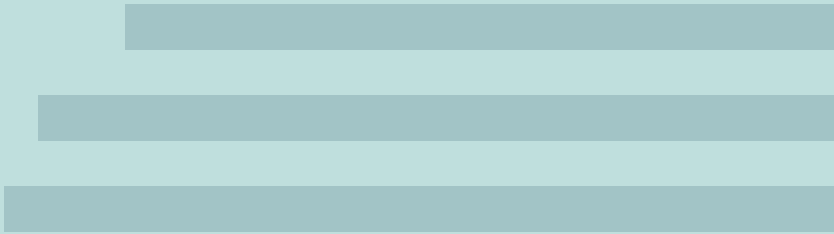



# Goals and Strategies

The Volkswagen Group aims to increase its unit sales and profitability for the long term. This is why its Strategy 2018 – with which Volkswagen intends to become the global economic and environmental leader among automobile manufacturers by 2018 – has been anchored in the Company.

Our Strategy 2018 focuses on positioning the Volkswagen Group as a global economic and environmental leader among automobile manufacturers. We have defined four goals that are intended to make Volkswagen the most successful, fascinating and sustainable automaker in the world by 2018:

- > Volkswagen intends to deploy intelligent innovations and technologies to become a world leader in customer satisfaction and quality. We see high customer satisfaction as one of the key requirements for the Company's long-term success.
- > The goal is to increase unit sales to more than 10 million vehicles a year; in particular, Volkswagen intends to capture an above-average share of growth in the major growth markets.
- > Volkswagen's aim is a long-term return on sales before tax of at least 8% so as to ensure that the Group's solid financial position and ability to act are guaranteed even in difficult market periods.
- > Volkswagen aims to be the most attractive employer in the automotive industry by 2018. To build the best vehicles, we need the best team in the sector; highly qualified, fit and, above all, motivated.

We are focusing in particular on the environmentally friendly orientation and profitability of our vehicle projects so that the

Volkswagen Group has the right products for success even in more challenging economic conditions. At the same time, this will mean that capital expenditure remains at manageable levels. Our attractive and environmentally friendly range of vehicles, which we are selectively expanding, and the strong position enjoyed by our individual brands in the markets worldwide, are key factors allowing us to leverage the Group's strengths and to systematically increase our competitive advantages.

Our activities are primarily oriented on setting new ecological standards in the areas of vehicles, drivetrains and lightweight construction. Our modular toolkit system, which we are enhancing on an ongoing basis, allows us to constantly improve production efficiency and flexibility, thus increasing the Group's profitability.

In addition, we want to continually expand the Volkswagen Group's customer base by further increasing satisfaction among our existing customers and acquiring new, satisfied customers around the world, particularly in the growth markets. In order to ensure this, we are increasingly adapting our products to meet local requirements and focusing on the specific features of individual markets. We shall continue the measures we are currently taking to improve our productivity and quality regardless of the economic situation and without any time limit. These include our regional development teams and our cooperation with local suppliers, among other things. Other key elements include standardizing processes in both the direct and indirect areas of the Group and reducing production throughput times. Together with disciplined cost and investment management, these measures play a major role in ensuring that we reach our long-term profitability targets and safeguard solid long-term liquidity.

We will only successfully meet the challenges of today and tomorrow if all employees – from vocational trainees through to senior executives – consistently deliver excellence so as to ensure the quality of the Volkswagen Group's innovations and products for the long term and at the highest level. Outstanding performance, the success that comes from it and participation in its rewards are at the heart of our human resources strategy.

## STRATEGY 2018

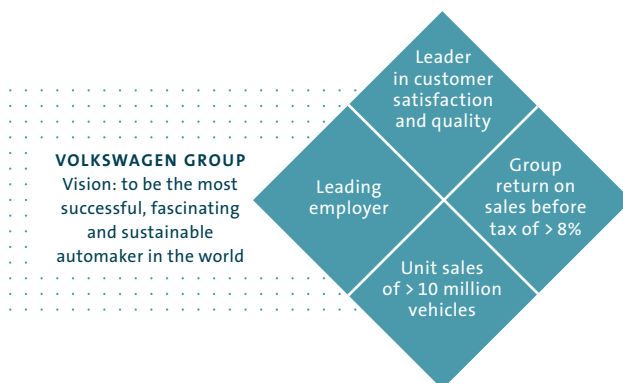

# *Internal Management System and Key Performance Indicators*

Based on the goals set out in our Strategy 2018, this chapter describes how the Volkswagen Group is managed and the key performance indicators used for this. Alongside financial measures, our management system also contains nonfinancial key performance indicators.

The Volkswagen Group's performance and success can be measured using both financial and nonfinancial key performance indicators. The following starts by describing the internal management process, and then explains the Volkswagen Group's core performance indicators.

## INTERNAL MANAGEMENT PROCESS IN THE VOLKSWAGEN GROUP

The starting point for the Volkswagen Group's internal management is the medium-term planning conducted once a year. This covers a period of five years and forms the core of our operational planning. It is used to formulate and check the requirements for realizing strategic projects designed to meet Group targets in technical and economic terms – and particularly in relation to earnings and liquidity effects. In addition, it is used to coordinate all business areas with respect to the strategic action areas concerned: functions/processes, products and markets.

When planning the Company's future, the individual planning components are determined on the basis of the timescale involved:

- > The long-term unit sales plan, which sets out market and segment growth and then derives the Volkswagen Group's delivery volumes from them.
- > The product program as the strategic, long-term factor determining corporate policy.
- > Capacity and utilization planning for the individual locations.

The coordinated results of the upstream planning processes are used as the basis for the medium-term financial planning: the Group's financial planning, including the brands and business fields, comprises the income statement, cash flow and balance sheet planning, profitability and liquidity, as well as the upfront investments needed for alternative products and the implementation of strategic options.

The first year of the medium-term planning period is then fixed and a budget drawn up for the individual months. This is planned in detail down to the level of the operating cost centers.

During the year, the budget is reviewed each month to establish the degree to which the targets have been met. In the process, target/actual comparisons, prior-year comparisons, variance analyses and, if necessary, action plans to ensure targets are met, are indispensable instruments within the management system. For the current fiscal year, detailed revolving monthly forecasts are prepared for the coming three months and the full year. These forecasts take into account the current risks and opportunities. The focus of intrayear internal management is therefore on adapting ongoing operations. At the same time, the current forecast serves as a potential, ongoing corrective to the medium-term and budget planning that follows on from it.

**CORE PERFORMANCE INDICATORS FOR INTERNAL MANAGEMENT**

The Volkswagen Group's internal management is based on seven core performance indicators, which are derived from the goals set out in our Strategy 2018:

**CORE PERFORMANCE INDICATORS IN THE VOLKSWAGEN GROUP**

Deliveries to customers
Sales revenue
Operating profit
Operating return on sales
Capex/sales revenue in the Automotive Division
Net cash flow in the Automotive Division
Return on investment (ROI) in the Automotive Division

Deliveries to customers are defined as the handover of a new vehicle to the end customer. This figure shows the popularity of our products with customers and is the measure we use to determine our competitive position in our markets. Increasing deliveries to customers is closely linked to our objectives of offering superior customer satisfaction and quality, as well as achieving unit sales of more than 10 million vehicles. High customer satisfaction, combined with and based on the outstanding quality of our vehicles, is one of the most important preconditions for the Company's success. Demand for our products is what drives our unit sales and production, and hence determines capacity utilization at our locations. Only a top team can meet the goals we have set ourselves and ensure long-term financial success.

Sales revenue, which does not include the figures for our equity-accounted Chinese joint ventures, reflects our market success in financial terms. Following adjustment for our use of resources, operating profit reflects the Company's actual business activity and documents economic output in our core business. The operating return on sales is the ratio of operating profit to sales revenue.

The ratio of investments in property, plant and equipment (capex) to sales revenue in the Automotive Division represents both our innovative power and our competitiveness. It compares our capital expenditure – largely for modernizing and expanding our product range and environmentally friendly drivetrains, as well as for increasing capacity and improving production processes – to the Automotive Division's sales revenue.

Net cash flow in the Automotive Division represents the excess funds from operating activities available for dividend payments, for example. It is calculated as cash flows from operating activities less cash flows from investing activities attributable to operating activities.

We use the return on investment (RoI) to calculate the return on invested capital for a particular period in the Automotive Division, including the Chinese joint ventures on a proportionate basis, by calculating the ratio of operating profit after tax to invested capital. If the return on investment (RoI) exceeds the market cost of capital, the value of the Company has increased. This is how we measure the success of our brands, locations and vehicle projects.

You can find information and explanations on the sales figures and the Volkswagen Group's financial key performance indicators on pages 78ff. and 94ff.

Detailed descriptions of our activities and additional nonfinancial key performance indicators in the areas of corporate social responsibility, research and development, procurement, production, sales and marketing, quality assurance, employees, information technology and environmental management can be found in the chapter entitled "Sustainable Value Enhancement" beginning on page 113 of this Annual Report.

# Structure and Business Activities

This chapter describes the legal and organizational structure of the Volkswagen Group and explains the material changes in 2013 with respect to equity investments.

## OUTLINE OF THE LEGAL STRUCTURE OF THE GROUP

Volkswagen AG is the parent company of the Volkswagen Group. It develops vehicles and components for the Group's brands, but also produces and sells vehicles, in particular passenger cars and light commercial vehicles for the Volkswagen Passenger Cars and Volkswagen Commercial Vehicles brands. In its function as parent company, Volkswagen AG holds direct and indirect interests in AUDI AG, SEAT S.A., ŠKODA AUTO a.s., Scania AB, MAN SE, Dr. Ing. h.c. F. Porsche AG, Volkswagen Financial Services AG and a large number of other companies in Germany and abroad. More detailed disclosures are contained in the list of shareholdings in accordance with sections 285 and 313 of the Handelsgesetzbuch (HGB – German Commercial Code), which can be accessed at [www.volkswagenag.com/ir](http://www.volkswagenag.com/ir) and is part of the annual financial statements.

Volkswagen AG is a vertically integrated energy company within the meaning of section 3 no. 38 of the Energiewirtschaftsgesetz (EnWG – German Energy Industry Act) and is therefore subject to the provisions of the EnWG. In the electricity sector, Volkswagen AG performs electricity generation, sales and distribution together with a Group subsidiary.

Volkswagen AG's Board of Management is the ultimate body responsible for managing the Group. The Supervisory Board appoints, monitors and advises the Board of Management; it is consulted directly on decisions that are of fundamental significance for the Company.

Information on the remuneration structure for the Board of Management and the Supervisory Board can be found in the Remuneration Report on pages 60 to 64, in the notes to the consolidated financial statements of Volkswagen AG on page 282 and on page 43 of the notes to the annual financial statements of Volkswagen AG.

## ORGANIZATIONAL STRUCTURE OF THE GROUP

The Volkswagen Group is one of the leading multibrand groups in the automotive industry. The Company's business activities comprise the Automotive and Financial Services divisions. All brands in the Automotive Division – with the exception of the Volkswagen Passenger Cars and Volkswagen Commercial Vehicles brands – are legally independent separate companies. The business activities of the various companies in the Volkswagen Group focus on developing, producing and selling passenger cars, light commercial vehicles, trucks and buses. The product portfolio ranges from motorcycles through fuel-efficient small cars down to luxury vehicles. In the commercial vehicles segment, the offering begins with small pickups and extends to buses and heavy trucks. Other business fields manufacture large-bore diesel engines and special gear units, among other things. A broad range of financial services rounds off the offering. With its brands, the Volkswagen Group has a presence in all relevant markets around the world. Western Europe, China, Brazil, the USA, Russia, Mexico and Argentina are currently the key sales markets for the Group.



# Corporate Governance Report

The future of the Volkswagen Group depends on our ability to continually increase the Company's value. Strengthening the trust of our customers and investors is fundamental to this. Transparent and responsible corporate governance therefore takes the highest priority in our daily work.

## GERMAN CORPORATE GOVERNANCE CODE – A BLUEPRINT FOR SUCCESSFUL CORPORATE GOVERNANCE

The German Corporate Governance Code contains recommendations and suggestions for good and responsible corporate governance. It was prepared by the government commission established for the purpose on the basis of the material statutory provisions and nationally and internationally accepted standards of corporate governance. The government commission reviews the German Corporate Governance Code in light of national and international developments on an annual basis and updates it as necessary. The work of the Board of Management and the Supervisory Board of Volkswagen AG is based on the recommendations and suggestions of the German Corporate Governance Code. We consider responsible and transparent corporate governance to be a key prerequisite for sustainably increasing the Company's value. It helps strengthen the trust of our customers and investors in our work and meet the steadily increasing demand for information from national and international stakeholders.

## DECLARATIONS OF CONFORMITY (AS OF THE DATE OF THE RELEVANT DECLARATION)

On February 22, 2013, the Board of Management and the Supervisory Board of Volkswagen AG issued a supplement to the declaration of conformity with the recommendations of the German Corporate Governance Code as required by section 161 of the Aktiengesetz (AktG – German Stock Corporation Act) dated November 23, 2012. This supplement became necessary due to changes in the application of the Code since the declaration of conformity was submitted. In this document, the Board of Management and Supervisory Board declare that the recommendations by the Government Commission on the German Corporate Governance Code of May 15, 2012 published by the German Federal Ministry of Justice on June 15, 2012 (2012 German Corporate Governance Code) have been complied with in full, with the exception of articles 4.2.3(4) (severance payment cap), 5.1.2(2) sentence 3 (age limit for members of the Board of Management), 5.3.2 sentence 3 (inde-

pendence of the Chairman of the Audit Committee), 5.4.1 (4 to 6) (disclosure regarding election recommendations), 5.4.6(2) (performance-related remuneration of members of the Supervisory Board) and 5.5.3 sentence 1 (report to the Annual General Meeting about conflicts of interest that have arisen and how they are being handled). The Board of Management and Supervisory Board also declare that the declaration of conformity submitted on November 23, 2012 has been qualified to exclude compliance with the recommendation in article 4.2.3(3) sentence 3 (exclusion of retroactive changes to comparative parameters) for the 2012 bonus. The reason for this additional exception can be found in the supplement to the declaration of conformity issued on February 22, 2013, which is published on our website, [www.volkswagenag.com/ir](http://www.volkswagenag.com/ir), under the heading "Corporate Governance", menu item "Declarations".

The Board of Management and the Supervisory Board of Volkswagen AG issued the annual declaration of conformity with the German Corporate Governance Code as required by section 161 of the AktG on November 22, 2013. In this document, they declare that, in the period between the declaration of November 23, 2012 and the announcement of the new version of the German Corporate Governance Code dated May 13, 2013 on June 10, 2013, the recommendations of the 2012 German Corporate Governance Code were complied with, with the exception of articles 4.2.3(4) (severance payment cap), 5.1.2(2) sentence 3 (age limit for members of the Board of Management), 5.3.2 sentence 3 (independence of the Chairman of the Audit Committee), 5.4.1(4 to 6) (disclosure regarding election recommendations), 5.4.6(2) (performance-related remuneration of members of the Supervisory Board), 5.5.3 sentence 1 (report to the Annual General Meeting about conflicts of interest that have arisen and how they are being handled) and 4.2.3(3) sentence 3 (exclusion of retroactive changes to comparative parameters).

From June 10, 2013 until submission of the declaration of November 22, 2013, the recommendations of the Government Commission on the German Corporate Governance Code of May 13, 2013 published by the German Federal Ministry of Justice on

June 10, 2013 (2013 German Corporate Governance Code) were complied with, with the following exceptions: articles 4.2.3(4) (severance payment cap), 5.1.2(2) sentence 3 (age limit for members of the Board of Management), 5.3.2 sentence 3 (independence of the Chairman of the Audit Committee), 5.4.1(4 to 6) (disclosure regarding election recommendations), 5.4.6(2) (performance-related remuneration of members of the Supervisory Board), 5.5.3 sentence 1 (report to the Annual General Meeting about conflicts of interest that have arisen and how they are being handled) and 4.2.2(2) sentence 3 (vertical comparison of remuneration).

In this document, the Board of Management and Supervisory Board also declare that, as of the declaration of November 22, 2013, the recommendations of the 2013 German Corporate Governance Code have been and will continue to be complied with, with the exception of articles 4.2.3(4) (severance payment cap), 5.1.2(2) sentence 3 (age limit for members of the Board of Management), 5.3.2 sentence 3 (independence of the Chairman of the Audit Committee), 5.4.1(4 to 6) (disclosure regarding election recommendations), 5.4.6(2) (performance-related remuneration of members of the Supervisory Board) and 5.5.3 sentence 1 (report to the Annual General Meeting about conflicts of interest that have arisen and how they are being handled).

The reasons for these exceptions can be found in the declaration of conformity, which is published on our website, [www.volkswagenag.com/ir](http://www.volkswagenag.com/ir), under the heading "Corporate Governance", menu item "Declarations".

The suggestions of the current version of the German Corporate Governance Code are complied with in full.

Our listed subsidiaries AUDIAG, MAN SE and Renk AG have also issued declarations of conformity with the German Corporate Governance Code.

The Board of Management and the Supervisory Board of AUDIAG issued the declaration of conformity with the German Corporate Governance Code on November 28, 2013. In this document, they state that the recommendations of the 2012 German Corporate Governance Code were complied with until the announcement of the 2013 German Corporate Governance Code on June 10, 2013. However, there were qualifications to articles 5.1.2(2) sentence 3 and 5.4.1(2) sentence 1 (age limit for Board of Management and Supervisory Board members), 5.3.2 sentence 3 (independence of the Chairman of the Audit Committee), 5.3.3 (nomination committee), 5.4.1(4 to 6) (disclosure regarding election recommendations), 5.4.2 (no more than two former Board of Management members to sit on the Supervisory Board), 5.4.3 sentence 1 (election to the Supervisory Board on an individual basis), 5.4.6(2) sentence 2 (performance-related remuneration of members of the Supervisory Board) and 5.5.3 sentence 1 (report to the Annual General Meeting about conflicts of interest that have arisen and how they are being handled). The departure from article 5.4.3 sentence 1 (election to the Supervisory Board on an individual basis) applied until May 15, 2013, after which this recommendation was complied with.

In this document, the two Boards furthermore declared that, as of June 10, 2013, the recommendations of the 2013 German Corporate Governance Code were and will continue to be complied with, with the exception of articles 4.2.3(2) sentence 6 (caps on overall remuneration of the Board of Management and in respect of their variable remuneration components), 5.1.2(2) sentence 3 and 5.4.1(2) sentence 1 (age limit for Board of Management and Supervisory Board members), 5.3.2 sentence 3 (independence of the Audit Committee Chairman), 5.3.3 (nomination committee), 5.4.1(4 to 6) (disclosure regarding election recommendations), 5.4.2 sentence 3 (no more than two former Board of Management members to sit on the Supervisory Board), 5.4.6(2) sentence 2 (performance-related remuneration of members of the Supervisory Board), 5.5.3 sentence 1 (report to the Annual General Meeting about conflicts of interest that have arisen and how they are being handled).

The reasons for these exceptions are explained in the declaration of conformity, which is published at [www.audi.com/cgk-declaration](http://www.audi.com/cgk-declaration).

AUDIAG complies with the suggestions of the current version of the German Corporate Governance Code without exception.

In their declaration of conformity with the German Corporate Governance Code of December 2013, the Executive Board and Supervisory Board of MAN SE declared that, in the period from December 2012 to June 10, 2013, the recommendations of the 2012 German Corporate Governance Code were complied with, with the exception of articles 5.3.2 sentence 3 (independence of the Chairman of the Audit Committee), 5.4.6(2) sentence 2 (performance-related remuneration of members of the Supervisory Board) and 5.5.3 sentence 1 (report to the Annual General Meeting about conflicts of interest that have arisen and how they are being handled).

**i** **DECLARATION OF CONFORMITY OF VOLKSWAGEN AG**  
[www.volkswagenag.com/ir](http://www.volkswagenag.com/ir)

**i** **DECLARATION OF CONFORMITY OF AUDI AG**  
[www.audi.com/cgk-declaration](http://www.audi.com/cgk-declaration)

**i** **DECLARATION OF CONFORMITY OF MAN SE**  
[www.corporate.man.eu/en](http://www.corporate.man.eu/en)

**i** **DECLARATION OF CONFORMITY OF RENK AG**  
[www.renk.biz/corporated-governance.html](http://www.renk.biz/corporated-governance.html)

**i** **CORPORATE GOVERNANCE AT SCANIA AB**  
[www.scania.com/scania-group/corporate-governance](http://www.scania.com/scania-group/corporate-governance)

From June 10, 2013 until submission of the current declaration of conformity, the recommendations of the 2013 German Corporate Governance Code were complied with, with the exception of articles 4.2.2(2) sentence 3 (vertical comparison of remuneration), 5.3.2 sentence 3 (independence of the Chairman of the Audit Committee), 5.4.6(2) sentence 2 (performance-related remuneration of members of the Supervisory Board) and 5.5.3 sentence 1 (report to the Annual General Meeting about conflicts of interest that have arisen and how they are being handled). Following the necessary consultations and the corresponding decision by the Supervisory Board, article 4.2.2(2) sentence 3 (vertical comparison of remuneration) has also been complied with since November 15, 2013.

The Executive Board and Supervisory Board of MAN SE also declare that, as of the date of issue of the current declaration in December 2013, the recommendations of the 2013 German Corporate Governance Code have been complied with, with the exception of articles 5.3.2 sentence 3 (independence of the Chairman of the Audit Committee), 5.4.1(4 to 6) (disclosure regarding election recommendations), 5.4.6(2) sentence 2 (performance-related remuneration of members of the Supervisory Board) and 5.5.3 sentence 1 (report to the Annual General Meeting about conflicts of interest that have arisen and how they are being handled).

The reasons for these exceptions are explained in the declaration of conformity, which is available at [www.corporate.man.eu/en](http://www.corporate.man.eu/en) under the heading "Investor Relations".

At Scania AB, the management and supervisory functions are split between the Annual General Meeting, the Board of Directors, and the President and CEO. They are governed by the articles of association, Swedish company law, the stock exchange admission criteria and other laws and regulations, such as the Swedish Corporate Governance Code. Additional details on Scania AB's corporate governance and the relevant declaration of conformity with the Swedish Corporate Governance Code are available at [www.scania.com/scania-group/corporate-governance](http://www.scania.com/scania-group/corporate-governance).

#### COMPOSITION OF THE SUPERVISORY BOARD

In view of the purpose of the Company, its size and the extent of its international activities, the Supervisory Board of Volkswagen AG strives to take the following criteria into account in its composition:

- > At least three members of the Supervisory Board should be persons who embody in particular the characteristic of internationality.
- > At least four shareholder representative members of the Supervisory Board should be persons who do not represent potential conflicts of interest, particularly conflicts of interest that could arise through a position as a consultant or member of the governing bodies of customers, suppliers, lenders, or other third parties.

- > In addition, at least four of the shareholder representatives must be persons who are independent as defined by article 5.4.2 of the German Corporate Governance Code.
- > At least three Supervisory Board members should be women, including at least two female shareholder representatives.
- > In addition, proposals for elections should not normally include persons who will have reached the age of 75 by the time the election takes place.

The first four criteria have already been met. As a rule, individuals will also not be proposed for election to the Supervisory Board if they are 75 or older at the time of the election.

#### COOPERATION BETWEEN THE BOARD OF MANAGEMENT AND THE SUPERVISORY BOARD

The Supervisory Board advises and monitors the Board of Management with regard to the management of the Company. It is directly involved in decisions of fundamental importance to the Group. The Board of Management and Supervisory Board of Volkswagen AG consult closely on the strategic orientation of the Volkswagen Group. The two boards jointly assess the progress made in implementing the strategy at regular intervals. The Board of Management reports to the Supervisory Board regularly, promptly and comprehensively in both written and oral form on all issues of relevance to strategy, planning, the development of the business, the risk situation, risk management and compliance.

More information on the cooperation between the Board of Management and the Supervisory Board of Volkswagen AG and on the work and structure of the committees of the Supervisory Board can be found in the Report of the Supervisory Board on pages 7 to 11 of this annual report. Information on the members of the Board of Management and Supervisory Board, as well as on the Supervisory Board committees, can be found on pages 65 to 68.

#### REMUNERATION REPORT

Extensive explanations of the remuneration system and the individual remuneration of the members of the Board of Management and the Supervisory Board may be found in the Remuneration Report on pages 60 to 64 of this annual report.

#### CORPORATE GOVERNANCE DECLARATION

The corporate governance declaration, which is part of the combined management report, is permanently available on our website at [www.volkswagenag.com/ir](http://www.volkswagenag.com/ir) under the heading "Mandatory Publications".



## COMPLIANCE

Compliance with international rules and the fair treatment of our business partners and competitors are among the guiding principles followed by our Company. Volkswagen's commitment has always gone beyond statutory and internal requirements; voluntary obligations and ethical principles also form an integral part of our corporate culture.

The Volkswagen Group is also active in the fight against corruption and other illegal economic activity outside of the Company. Since 2002, we have been a member of the United Nations Global Compact, working with around 10,000 participating companies from more than 130 countries to create a more sustainable and fairer global economy.

### Commitment to compliance at the highest level

Compliance is a cornerstone of sustainable business – a view expressly shared by the Company's management. Speaking to an audience of more than 5,000 at a management event in 2013, Chairman of the Board of Management of the Volkswagen Group, Prof. Dr. Martin Winterkorn, emphasized this point: "Operating a sustainable business means we continue to take the subject of compliance seriously. We do not break the law, or other rules and regulations! This applies to all our brands and in all regions. Volkswagen enjoys an excellent reputation internationally. It is our responsibility as managers to ensure that it is upheld." Other members of the Group Board of Management and brand boards of management also called on the workforce to comply with the rules during the past fiscal year.

### Preventive compliance management system

Compliance is an important part of the Governance, Risk and Compliance (GRC) organization in the Volkswagen Group (see the Report on Risks and Opportunities starting on page 151). As part of this, Volkswagen adopts a preventive compliance approach and aims to create a corporate culture that stops potential breaches before they occur by raising awareness and educating employees. Group Internal Audit and Group Security regularly perform the necessary investigative measures, systematically monitor compliance and perform random checks regardless of any suspicion of infringements, as well as investigating specific suspected breaches. Responses are implemented by the Human Resources and Group Legal departments. These processes are closely interrelated, in line with the concept of a comprehensive compliance management system.

Various bodies support the work of the compliance organization at Group and brand company level. These include the Compliance Board at senior management level and the core Compliance team, which ensures coordination with the functional areas.

### Focal points in 2013

Each year, detailed compliance risk assessments are carried out across the Group as part of the standard GRC process. The results are factored into the risk analyses performed by the Volkswagen Group, the brands and the companies, and into the Compliance Program planning.

Compliance activities in 2013 focused on anti-corruption measures in China and on expanding the GRC organization. The China Compliance conference was held in Beijing in May 2013 to prophylactically tackle the subject of preventing corruption in the Chinese Group companies. The Conference was sponsored by the member of the Group Board of Management responsible for the China function and President and CEO of Volkswagen Group China, as well as the CEOs of the Chinese joint ventures FAW-Volkswagen Automotive Company Ltd. and Shanghai-Volkswagen Automotive Company Ltd. All three stressed in their speeches that compliance is a key element of corporate responsibility, helps to safeguard a company's image, and has a direct positive impact on business growth. Among other things, the conference provided an opportunity to train the local management, assess the specific situation in China from a compliance perspective and develop future local compliance strategies in workshops.

The Group Chief Compliance Officer is now supported by 14 Chief Compliance Officers, who are responsible for the brands, the Financial Services Division and Porsche Holding GmbH, Salzburg, as well as 175 compliance officers in the Group companies. In total, staff in 49 countries are employed in the GRC function.

### Work of the Governance, Risk and Compliance organization

The GRC organization provided information on various compliance issues to the Group's brands and companies over the year, using a wide range of traditional communication channels. These include reports in various employee magazines produced by the brands, companies and locations and information stands at works meetings. Electronic media such as intranet portals, smartphone apps, blogs and newsletters are also frequently used to provide compliance information. For example, International Anti-Corruption Day in early December was used at Volkswagen AG as an opportunity to launch a poster campaign highlighting the topic of corruption. The campaign was accompanied by articles in employee magazines, as well as a short animated film on the intranet.

Building on its Code of Conduct, Volkswagen has produced guidelines on various compliance topics. These cover anti-corruption – including checklists and the express prohibition of facilitation payments – and competition and antitrust law. These information documents were provided to employees either in paper form or electronically (on the intranet and the employee portal, for example) and made available to all brands to be adapted to their respective specific requirements.

There are also Group-wide directives on dealing with gifts and invitations, as well as on making donations.

We have communicated the Code of Conduct to all consolidated brand companies and established it as a fundamental part of our corporate culture. It is also increasingly being integrated into our operational processes. For example, since 2010, all new employment contracts entered into between Volkswagen AG on the one part and both management staff and employees covered by collective agreements on the other have included a reference to the Code of Conduct and the obligation to comply with it. In addition, since 2012, all new Volkswagen AG employees have been required to complete an e-learning program on the Group's Code of Conduct. The subject of human rights is an integral part of this training program.

Training on competition and antitrust law is provided to specific target groups. For example, it is a core component of the training provided to sales and procurement employees.

Due to the new requirements of the Geldwäschegesetz (GwG – German Money Laundering Act), a money laundering prevention concept has also been rolled out at the Group companies based in Germany.

The Company considers the excellent reputation enjoyed by the Volkswagen Group in the business world and among the public to be a precious asset. To safeguard its reputation, Volkswagen verifies the integrity of its business partners (business partner check). This check allows us to find out about potential business partners before entering into a relationship with them, reducing the risk of starting a cooperation that could be damaging to the Company or its business.

Providing information to employees at all levels continues to be a core component of our compliance work. Across the Group, approximately 119,000 employees attended events on the topics of compliance, the Code of Conduct, anti-corruption, human rights, anti-money laundering, and competition and antitrust law in 2013. E-learning programs are also an established means of providing employee training. Around 31,600 employees successfully completed the e-learning program on avoiding conflicts of interest and corruption in 2013. Certain Group companies have special e-learning programs on topics such as anti-money laundering. Around 158,000 employees have taken the opportunity for professional development by participating in e-learning programs on compliance issues since 2009.

Employees of all brand companies and a large number of Group companies are able to obtain personal advice about compliance issues, usually by contacting the compliance organization via a dedicated e-mail address. In 2013, employees made extensive use of the IT-based information and advisory tool launched at Volkswagen AG's German locations in 2012.

The Group-wide ombudsman system can be used to report any breaches or suspicions (particularly regarding corruption) in nine different languages to two external lawyers appointed by the Group. Naturally, the people providing the information need not fear being sanctioned by the Company for doing this. In 2013, the ombudsmen passed on 30 reports by people – whose details remained confidential if requested – to Volkswagen AG's Anti-Corruption Officer. In addition, the Anti-Corruption Officer and the head of Group Internal Audit received information on a further 65 cases directly. During local internal audits of the brands and Group companies, 251 reports of suspected fraud were submitted. All information is followed up. All breaches of the law or internal regulations are appropriately punished and may lead to consequences under employment law, including dismissal.

#### Effectiveness review

We review the effectiveness of the compliance measures taken at the Volkswagen Group's brands and companies annually using an integrated survey, which forms part of the standardized GRC process. We check the effectiveness of selected countermeasures as well as management controls used to manage compliance risks. In addition, the continuous improvement of the compliance management system is ensured through independent reviews by the Group Internal Audit function at the units and the regular exchange of information with external bodies, for example.

#### RISK MANAGEMENT

Carefully managing potential risks to the Company is a key component of our daily work. Volkswagen Group's risk management system is oriented toward identifying, assessing, communicating and managing risks. This system is reviewed on an ongoing basis and adjusted in line with new conditions as necessary. A detailed description of the risk management system and our accounting-related internal control system can be found in the Risk Report on pages 151 to 154 of this annual report.

The Supervisory Board has established an Audit Committee, which monitors the financial reporting process and the effectiveness of the internal control system, risk management, the internal audit system and compliance, in particular. It also supervises the audit of financial statements, particularly the independence of the auditors, the additional services provided by the auditors, the audit engagement, the definition of the areas of emphasis for the audit and the agreed fee. As recommended in article 5.3.2 of the German Corporate Governance Code, the Chairman of the Audit Committee, Dr. Ferdinand Oliver Porsche, has particular expertise and experience in the application of financial reporting principles and internal control systems.

#### COMMUNICATION AND TRANSPARENCY

The Volkswagen Group publishes a financial calendar listing all the important dates for its shareholders in its annual report and interim reports and on its website at [www.volkswagenag.com/ir](http://www.volkswagenag.com/ir). The invitations to and the agendas for the shareholders' meetings and any counter motions received are also available on this website. At the shareholders' meetings, shareholders may exercise their voting rights themselves, have this right exercised on their behalf by a third-party proxy whom they have appointed, or use a proxy designated by the Company who will vote on their behalf in accordance with their voting instructions. In addition, we offer our shareholders the opportunity to watch the Annual General Meetings in full on the Internet.

News and information on the Volkswagen Group are available on our website at [www.volkswagenag.com/ir](http://www.volkswagenag.com/ir). The releases and other information are published in both English and German.

Immediately after their publication in line with legal requirements, the Company's ad hoc releases are also published on our website at [www.volkswagenag.com/ir](http://www.volkswagenag.com/ir) under the heading "Mandatory Publications", menu item "Ad-hoc releases".

We publish directors' dealings (section 15a of the WpHG) at [www.volkswagenag.com/ir](http://www.volkswagenag.com/ir) under the heading "Mandatory Publications", menu item "Directors' Dealings".

In addition, details of the notifications filed in compliance with sections 21ff. of the Wertpapierhandelsgesetz (WpHG – German Securities Trading Act) during the reporting period can be found on this website under the heading "Mandatory Publications", menu item "Reporting of voting rights according to WpHG". Notifications relating to other legal issues may be downloaded there under the heading "Mandatory Publications", menu item "Other legal issues".

The supervisory body appointments held by Board of Management members and Supervisory Board members can be found on pages 65 to 68 of this annual report.



# Remuneration Report

The Remuneration Report details the individualized remuneration of the Board of Management and the Supervisory Board of Volkswagen AG, broken down into components, as well as individualized pension provision disclosures for the members of the Board of Management. In addition, we explain in this chapter the main elements of the variable remuneration system for the Board of Management.

## PRINCIPLES OF AND CHANGES TO BOARD OF MANAGEMENT REMUNERATION

The full Supervisory Board resolves on the remuneration system and the total remuneration for each individual member of Volkswagen AG's Board of Management on the basis of the Executive Committee's recommendations. The remuneration of current members of the Board of Management complies with the requirements of the Aktiengesetz (AktG – German Stock Corporation Act) and the recommendations of the German Corporate Governance Code. In particular, the remuneration structure is focused on ensuring sustainable business growth in accordance with the Gesetz zur Angemessenheit der Vorstandsvergütung (VorstAG – German Act on the Appropriateness of Executive Board Remuneration) (section 87(1) of the AktG).

The remuneration system of the members of the Board of Management applicable to date was approved by the 50th Annual General Meeting on April 22, 2010 by 99.44% of the votes cast. At the same time, the Volkswagen Group's positive business performance over the past few years made it necessary to modify and realign Board of Management remuneration and the comparative parameters on which it is based. The remuneration of the Board of Management was modified with the assistance of a remuneration consultant, whose independence has been assured by the Supervisory Board and by the Company.

Material changes to the remuneration system relate to the bonus, the calculation of which was realigned to reflect business development. It also explicitly takes into account the individual performance of members of the Board of Management.

The retroactive adjustment of the comparative parameters for the bonus was held on February 22, 2013 to be a departure from the recommendation in article 4.2.3(3) sentence 3 of the German Corporate Governance Code (in the version dated May 15, 2012), which precludes the retroactive adjustment of performance targets or comparative parameters. This departure was nonrecurring and was related to the bonus for 2012. This recommendation is now being complied with again.

The level of the Board of Management remuneration should be appropriate and attractive in the context of the Company's national and international peer group. Criteria include the tasks of the individual Board of Management member, their personal performance, the economic situation, the performance of and outlook for the Company, as well as how customary the remuneration is when measured against its peer group and the remuneration structure that applies to other areas of Volkswagen. In this context, comparative studies on remuneration are conducted on a regular basis.

## COMPONENTS OF BOARD OF MANAGEMENT REMUNERATION

The remuneration of the Board of Management comprises fixed and variable components. The fixed components of the package ensure firstly a basic level of remuneration enabling the individual members of the Board of Management to perform their duties in the interests of the Company and to fulfill their obligation to act with proper business prudence without needing to focus on merely short-term performance targets. On the other hand, variable components, dependent among other criteria on the financial performance of the Company, serve to ensure the long-term impact of behavioral incentives.

### Fixed remuneration

In fiscal year 2013, the members of the Board of Management received fixed remuneration totaling €11,638,328 (€9,506,343). The fixed remuneration also includes differing levels of remuneration for appointments assumed at Group companies as well as the cost or cash equivalent of noncash and other benefits, such as the use of company cars and the payment of insurance premiums. Taxes due on the noncash benefits were mainly borne by Volkswagen AG.

The basic remuneration is reviewed regularly and adjusted if necessary.

#### Variable remuneration

The variable remuneration comprises a bonus, which relates to business performance over the preceding two years, and, since 2010, a Long-Term Incentive (LTI) plan, which is based on the previous four fiscal years, subject to an introductory phase. Both components of variable remuneration are therefore calculated on a multiyear basis and reflect both positive and negative developments.

#### Bonus

The bonus rewards the positive business development of the Volkswagen Group. The basis for calculating the bonus is adjusted to reflect the positive business development in recent years in connection with the changes to Board of Management remuneration. The bonus is calculated on the basis of the average operating profit, including the proportionate operating profit in

China, over a period of two years. A significant change since February 22, 2013 was the introduction of a calculation floor below which no bonus will be paid. This floor was set at €5.0 billion for 2012 and 2013. In addition, a cap for extraordinary developments is explicitly provided for by limiting the maximum theoretical bonus. The theoretical cap for 2012 and 2013, subject to the performance-related bonus, is €6.75 million for the Chairman of the Board of Management and €2.5 million for the other members of the Board of Management. The system and the cap are regularly reviewed by the Supervisory Board to establish whether any adjustments are necessary.

Another material change since February 22, 2013 relates to the Supervisory Board's ability to increase the theoretical bonus, which is calculated on the basis of average operating profit, by up to 50% by applying individual adjustment factors that are not linked to the

#### REMUNERATION OF THE MEMBERS OF THE BOARD OF MANAGEMENT IN 2013 (PRIOR-YEAR FIGURES IN BRACKETS)\*

€	BONUS				LTI	Total
	Fixed remuneration	Special remuneration	Individual performance-related bonus			
Martin Winterkorn	1,907,862 (1,916,276)	6,002,000 (5,770,000)	3,001,000 (2,885,000)	4,095,000 (3,940,000)	<b>15,005,862</b> <b>(14,511,276)</b>	
Francisco Javier Garcia Sanz	1,241,017 (1,102,278)	2,233,000 (2,150,000)	1,116,500 (860,000)	1,820,000 (1,750,000)	<b>6,410,517</b> <b>(5,862,278)</b>	
Jochem Heizmann	1,209,945 (1,100,204)	2,233,000 (2,150,000)	669,900 (645,000)	1,820,000 (1,750,000)	<b>5,932,845</b> <b>(5,645,204)</b>	
Christian Klingler	1,241,017 (999,756)	2,233,000 (2,150,000)	893,200 (860,000)	1,820,000 (1,750,000)	<b>6,187,217</b> <b>(5,759,756)</b>	
Michael Macht	1,241,017 (995,277)	2,233,000 (2,150,000)	669,900 (430,000)	1,820,000 (1,750,000)	<b>5,963,917</b> <b>(5,325,277)</b>	
Horst Neumann	1,241,017 (1,062,771)	2,233,000 (2,150,000)	893,200 (860,000)	1,820,000 (1,750,000)	<b>6,187,217</b> <b>(5,822,771)</b>	
Leif Östling	1,210,126 (319,952)	2,233,000 (716,667)	669,900 (215,000)	1,820,000 (583,333)	<b>5,933,026</b> <b>(1,834,952)</b>	
Hans Dieter Pötsch	1,241,017 (1,025,047)	2,233,000 (2,150,000)	1,116,500 (1,075,000)	1,820,000 (1,750,000)	<b>6,410,517</b> <b>(6,000,047)</b>	
Rupert Stadler	1,105,310 (984,782)	2,233,000 (2,150,000)	893,200 (860,000)	1,820,000 (1,750,000)	<b>6,051,510</b> <b>(5,744,782)</b>	
<b>Total</b>	<b>11,638,328</b> <b>(9,506,343)</b>	<b>23,866,000</b> <b>(21,536,667)</b>	<b>9,923,300</b> <b>(8,690,000)</b>	<b>18,655,000</b> <b>(16,773,333)</b>	<b>64,082,628</b> <b>(56,506,343)</b>	

\* All figures shown are rounded, so minor discrepancies may arise from addition of these amounts.

theoretical cap so as to reward members of the Board of Management for extraordinary individual performance. This can be adjusted by the Supervisory Board in the event of extraordinary individual performance by a member of the Board of Management that strengthens the Company's long-term growth. This may take into account extraordinary performance in the area of integration, or the successful implementation of special projects, for example.

#### Long-Term Incentive (LTI)

The existing Long-Term Incentive plan was not adjusted as part of the changes to the Board of Management remuneration. The amount of the LTI depends on the achievement of the targets laid down in the Strategy 2018. The target areas are:

- > Leader in customer satisfaction, measured using the Customer Satisfaction Index,
  - > Leading employer, measured using the Employee Index,
  - > Unit sales growth, measured using the Growth Index, and
  - > Increase in the return on sales, measured using the Return Index.
- The Customer Satisfaction Index is calculated using indicators that quantify the overall satisfaction of our customers with the delivering dealers, new vehicles and the service operations based on the previous workshop visit.

The Employee Index is determined using the "employment" and "productivity" indicators as well as the participation rate and results of employee surveys ("opinion surveys", see also the Employees section on page 133 of this report).

The Growth Index is calculated using the "deliveries to customers" and "market share" indicators.

The Return Index is derived from the return on sales and the dividend per ordinary share.

The indices on customer satisfaction, employees and unit sales are aggregated and the result is multiplied by the Return Index. This method ensures that the LTI is only paid out if the Group is also financially successful. If the 1.5% threshold for the return on sales is not exceeded, the Return Index is zero. This would mean that the overall index for the fiscal year concerned is also zero.

Each fiscal year, the Supervisory Board can set a new LTI target on the basis of the four-year average of the overall indices. During the reporting period, the LTI target was €2.25 million for the Chairman of the Board of Management and €1.0 million for each of the other members of the Board of Management. The maximum amounts payable to the Chairman of the Board of Management and the other members are €4.5 million and €2.0 million each respectively.

The LTI was calculated and paid to the Board of Management for the first time in 2011 for fiscal year 2010 using an introductory scenario and on the basis of the likely performance for 2011. The performance for fiscal years 2010 and 2011 was reflected in the calculation in 2012, and the performance for 2010 to 2012 is reflected in the calculation in 2013. From 2014 onwards, the previous four years will be used as a basis for analysis.

The Supervisory Board may cap the total of variable remuneration components in the event of extraordinary business developments.

Members of the Board of Management with contracts entered into on or after January 1, 2010 are entitled to payment of their normal remuneration for twelve months in the event of illness. Contracts entered into before that date grant remuneration for six months. In the event of disability, they are entitled to the retirement pension. Surviving dependents receive a widows' pension of 66 2/3% and orphans' benefits of 20% of the former member of the Board of Management's pension.

#### POST-EMPLOYMENT BENEFITS

In the event of regular termination of their service on the Board of Management, the members of the Board of Management are entitled to a pension, including a surviving dependents' pension as well as the use of company cars for the period in which they receive their pension. The agreed benefits are paid or made available on reaching the age of 63.

The retirement pension is calculated as a percentage of the fixed basic salary, which accounts for most of the fixed individual remuneration of the Board of Management shown in the table on page 61. Starting at 50%, the individual percentage increases by two percentage points for each year of service. In specific cases, credit is given for previous employment periods and retirement pensions earned. The Executive Committee of the Supervisory Board has defined a maximum of 70%. These benefits are not broken down any further into performance-related components and long-term incentive components. Mr. Winterkorn, Mr. Garcia Sanz, Mr. Heizmann, Mr. Macht, Mr. Neumann and Mr. Pötsch have a retirement pension entitlement of 70%, and Mr. Klingler and Mr. Stadler of 58% of their fixed basic salaries as of the end of 2013.

Mr. Östling has a pension entitlement based on the deferred compensation regulations administered by Volkswagen Pension Trust e.V. The benefits include a retirement pension on reaching the age of 70 and a surviving dependents' pension. Volkswagen AG provides an annual remuneration-linked company contribution for Mr. Östling, which goes toward a pension module at the end of each year.

On December 31, 2013 the pension obligations for members of the Board of Management in accordance with IAS 19 amounted to €107,676,518 (€103,535,287); €9,416,406 (€7,870,299) was added to the provision in the reporting period in accordance with IAS 19. Other benefits such as surviving dependents' pension and the use of company cars are also factored into the measurement of pension provisions. The pension obligations measured in accordance with German GAAP amounted to €88,704,661 (€75,445,501); €13,259,160 (€3,627,309) was added to the provision in the reporting period in accordance with German GAAP. Current pensions are index-linked in accordance with the index-

linking of the highest collectively agreed salary insofar as the application of section 16 of the Gesetz zur Verbesserung der betrieblichen Altersversorgung (BetrAVG – German Company Pension Act) does not lead to a larger increase.

Retired members of the Board of Management and their surviving dependents received €9,977,972 in 2013 (€8,797,230). Obligations for pensions for this group of persons measured in accordance with IAS 19 amounted to €140,165,675 (€146,501,307), or €125,376,525 (€122,324,853) measured in accordance with German GAAP.

#### EARLY TERMINATION BENEFITS

If membership of the Board of Management is terminated for cause through no fault of the Board of Management member, the claims under Board of Management contracts entered into since November 20, 2009 are limited to a maximum of two years' remuneration, in accordance with the recommendation in article 4.2.3(4) of the German Corporate Governance Code (cap on severance payments). For Board of Management members who are commencing their third or later term of office, existing rights under contracts entered into before November 20, 2009 are grandfathered.

No severance payment is made if membership of the Board of Management is terminated for a reason for which the Board of Management member is responsible.

The members of the Board of Management are also entitled to a pension and to a surviving dependents' pension as well as the use of company cars for the period in which they receive their pension in the event of early termination of their service on the Board of Management.

The following rule applies to Board of Management contracts entered into for the first term of office before August 5, 2009: the retirement pension to be granted after leaving the Company is payable immediately if their membership of the Board of Management is terminated by the Company, and in other cases on reaching the age of 63. Any remuneration received from other sources until the age of 63 is deductible from the benefit entitlement up to a certain fixed amount.

The following rule applies to contracts for the first term of office of members of the Board of Management entered into after August 5, 2009: the retirement pension to be granted after leaving the Company is payable on reaching the age of 63.

#### PENSIONS OF THE MEMBERS OF THE BOARD OF MANAGEMENT IN 2013 (PRIOR-YEAR FIGURES IN BRACKETS)<sup>1</sup>

€	Additions to pension provisions	Present value at December 31 <sup>2</sup>
Martin Winterkorn	730,734 (904,811)	22,075,213 (22,835,450)
Francisco Javier Garcia Sanz	952,803 (842,801)	12,134,132 (11,579,920)
Jochem Heizmann	1,443,804 (1,303,902)	13,696,821 (12,637,000)
Christian Klingler	840,814 (583,862)	3,693,690 (2,961,689)
Michael Macht	1,045,270 (836,249)	10,632,210 (10,029,668)
Horst Neumann	583,826 (694,357)	17,470,333 (18,244,557)
Leif Östling	1,100,179 (353,925)	1,355,439 (354,065)
Hans Dieter Pötsch	1,926,251 (1,699,477)	15,994,320 (14,775,553)
Rupert Stadler	792,725 (650,915)	10,624,360 (10,117,385)
<b>Total</b>	<b>9,416,406</b> <b>(7,870,299)</b>	<b>107,676,518</b> <b>(103,535,287)</b>

1 All figures shown are rounded, so minor discrepancies may arise from addition of these amounts.

2 The amount is reported in the total amount for defined benefit plans reported in the balance sheet (see note 29 to the consolidated financial statements).

#### SUPERVISORY BOARD REMUNERATION

Under Article 17 of Volkswagen AG's Articles of Association, the remuneration of Volkswagen AG's Supervisory Board is composed of a fixed component (plus attendance fees) and a variable component that depends on the amount of the dividend paid. The duties performed by the respective member on the Supervisory Board are also taken into account. Several members of the Supervisory Board are also members of the supervisory boards of subsidiaries. The remuneration received there is based on the

provisions of the relevant Articles of Association and also comprises a fixed component and a variable component that is linked to the amount of the dividend paid. This remuneration is contained in the following figures. In fiscal year 2013, the members of the Supervisory Board received €9,774,530 (€8,777,511). €528,671 of this figure (€651,625) related to the fixed remuneration components (including attendance fees) and €9,245,859 (€8,125,886) to the variable remuneration components.

#### REMUNERATION OF THE MEMBERS OF THE SUPERVISORY BOARD<sup>1</sup>

€	FIXED	VARIABLE	TOTAL	TOTAL
			2013	2012
Ferdinand K. Piëch	121,000	1,068,300	1,189,300	1,108,100
Berthold Huber <sup>2</sup>	37,500	736,067	773,567	683,133
Hussain Ali Al-Abdulla	11,000	320,833	331,833	288,167
Jassim Al Kuwari (until April 25, 2013)	2,917	102,488	105,405	289,167
Jörg Bode (until Feb. 19, 2013) <sup>3</sup>	808	43,223	44,032	394,540
Ahmad Al-Sayed (since June 28, 2013)	4,050	163,090	167,140	–
Jürgen Dorn (since Jan. 1, 2013) <sup>2</sup>	53,000	355,833	408,833	–
Annika Falkengren	13,000	481,250	494,250	390,777
Hans-Peter Fischer (since Jan. 1, 2013) <sup>2</sup>	11,000	320,833	331,833	–
Uwe Fritsch <sup>2</sup>	11,000	320,833	331,833	203,221
Babette Fröhlich <sup>2</sup>	14,000	481,250	495,250	433,750
Olaf Lies (since Feb. 19, 2013) <sup>3</sup>	10,192	277,610	287,802	–
David McAllister (until Feb. 19, 2013) <sup>3</sup>	1,213	64,835	66,048	433,750
Hartmut Meine <sup>2</sup>	11,000	320,833	331,833	291,167
Peter Mosch <sup>2</sup>	29,800	541,356	571,156	371,267
Bernd Osterloh <sup>2</sup>	14,000	481,250	495,250	433,750
Hans Michel Piëch	37,500	368,033	405,533	390,567
Ursula Piëch	18,125	350,333	368,458	203,221
Ferdinand Oliver Porsche	40,500	712,467	752,967	687,433
Wolfgang Porsche	49,500	528,450	577,950	548,015
Stephan Weil (since Feb. 19, 2013) <sup>3</sup>	12,767	415,301	428,068	–
Stephan Wolf (since Jan. 1, 2013) <sup>2</sup>	13,800	470,556	484,356	–
Thomas Zwiebler <sup>2</sup>	11,000	320,833	331,833	291,167
Supervisory Board members who retired in the prior year	–	–	–	1,336,321
<b>Total</b>	<b>528,671</b>	<b>9,245,859</b>	<b>9,774,530</b>	<b>8,777,511</b>

1 All figures shown are rounded, so minor discrepancies may arise from addition of these amounts.

2 These employee representatives have stated that they will transfer their Supervisory Board remuneration to the Hans Böckler Foundation in accordance with the guidelines issued by the German Confederation of Trade Unions (DGB).

3 Under section 5(3) of the Niedersächsisches Ministergesetz (Act Governing Ministers of the State of Lower Saxony), these members of the Supervisory Board are obliged to transfer their Supervisory Board remuneration to the State of Lower Saxony as soon as and to the extent that it exceeds €6,200 per annum. Remuneration is defined for this purpose as Supervisory Board remuneration and attendance fees exceeding the amount of €200.



# Executive Bodies

Members of the Board of Management and their Appointments  
Appointments: as of December 31, 2013

**PROF. DR. DR. H.C. MULT.**

**MARTIN WINTERKORN (66)**

Chairman (since January 1, 2007),  
Research and Development  
July 1, 2000\*

Chairman of the Executive Board  
of Porsche Automobil Holding SE  
November 25, 2009\*

**Appointments:**

○ FC Bayern München AG, Munich

**DR. RER. POL. H.C.**

**FRANCISCO JAVIER**

**GARCIA SANZ (56)**

Procurement

July 1, 2001\*

**Appointments:**

○ Hochtief AG, Essen

⊙ Criteria CaixaHolding S.A., Barcelona

**PROF. DR. RER. POL. DR.-ING. E.H.**

**JOCHEM HEIZMANN (62)**

China

January 11, 2007\*

**Appointments:**

○ Lufthansa Technik AG, Hamburg

⊙ OBO Bettermann GmbH & Co. KG, Menden

**CHRISTIAN KLINGLER (45)**

Sales and Marketing

January 1, 2010\*

**Appointments:**

⊙ Messe Frankfurt GmbH, Frankfurt am Main

**DR.-ING. E.H. MICHAEL MACHT (53)**

Production

October 1, 2010\*

**PROF. DR. RER. POL. HORST NEUMANN (64)**

Human Resources and Organization

December 1, 2005\*

**Appointments:**

○ Wolfsburg AG, Wolfsburg

**DR. H.C. LEIF ÖSTLING (68)**

Commercial Vehicles

September 1, 2012\*

**Appointments:**

⊙ SKF AB, Gothenburg

⊙ EQT Holdings AB, Stockholm

**HANS DIETER PÖTSCH (62)**

Finance and Controlling

January 1, 2003\*

Chief Financial Officer

of Porsche Automobil Holding SE

November 25, 2009\*

**Appointments:**

○ Bertelsmann SE & Co. KGaA, Gütersloh

**PROF. RUPERT STADLER (50)**

Chairman of the Board of Management of AUDI AG

January 1, 2010\*

**Appointments:**

○ FC Bayern München AG, Munich

As part of their duty to manage and supervise the Group's business, the members of the Board of Management hold other offices on the supervisory boards of consolidated Group companies and other significant investees.

○ Membership of statutory supervisory boards in Germany.

⊙ Comparable appointments in Germany and abroad.

\* The date signifies the beginning or period of membership of the Board of Management.

## Members of the Supervisory Board and their Appointments Appointments: as of December 31, 2013

### HON.-PROF. DR. TECHN. H.C.

#### DIPL.-ING. ETH FERDINAND K. PIËCH (76)

(Chairman)

April 16, 2002\*

##### Appointments:

- AUDI AG, Ingolstadt
- Dr. Ing. h.c. F. Porsche AG, Stuttgart
- MAN SE, Munich (Chairman)
- Porsche Automobil Holding SE, Stuttgart
- Ducati Motor Holding S.p.A., Bologna
- Porsche Gesellschaft m.b.H., Salzburg
- Porsche Holding Gesellschaft m.b.H., Salzburg
- Porsche Piech Holding GmbH, Salzburg
- Scania AB, Södertälje
- Scania CV AB, Södertälje

#### BERTHOLD HUBER (63)

(Deputy Chairman)

IG Metall

May 25, 2010\*

##### Appointments:

- AUDI AG, Ingolstadt (Deputy Chairman)
- Porsche Automobil Holding SE, Stuttgart
- Siemens AG, Munich (Deputy Chairman)

### DR. JUR. KLAUS LIESEN (82)

July 2, 1987 – May 3, 2006\*

Honorary Chairman of the Supervisory Board of  
Volkswagen AG (since May 3, 2006)

### DR. HUSSAIN ALI AL-ABDULLA (57)

Board member of Qatar Holding LLC

April 22, 2010\*

##### Appointments:

- Gulf Investment Corporation, Safat/Kuwait
- Masraf Al Rayan, Doha (Chairman)
- Qatar Exchange, Doha (Chairman)
- Qatar Investment Authority, Doha
- Qatar Holding LLC, Doha

### KHALIFA JASSIM AL-KUWARI (37)

May 3, 2011 – April 25, 2013\*

### AHMAD AL-SAYED (37)

CEO of the Qatar Investment  
Authority and Managing Director (CEO)  
of Qatar Holding LLC

June 28, 2013\*

##### Appointments:

- Canary Wharf Group, London
- Qatar Exchange, Doha (Deputy Chairman)
- Qatar National Bank, Doha

### JÖRG BODE (43)

November 4, 2009 – February 19, 2013\*

### JÜRGEN DORN (47)

Chairman of the Works Council at the MAN Truck &  
Bus AG Munich plant, Chairman of the General Works  
Council of MAN Truck & Bus AG and Chairman of the  
Group Works Council and the SE Works Council of  
MAN SE

January 1, 2013\*

##### Appointments:

- MAN SE, Munich
- MAN Truck & Bus AG, Munich (Deputy Chairman)

### ANNIKA FALKENGREN (51)

President and Group Chief Executive of Skandinaviska  
Enskilda Banken AB

May 3, 2011\*

##### Appointments:

- Münchener Rückversicherungs-  
Gesellschaft AG, Munich
- Securitas AB, Stockholm

**DR. JUR. HANS-PETER FISCHER (54)**

Chairman of the Board of Management of Volkswagen Management Association  
January 1, 2013\*

**Appointments:**

- ⊙ Volkswagen Pension Trust e.V., Wolfsburg

**UWE FRITSCH (57)**

Chairman of the Works Council at the Volkswagen AG Braunschweig plant  
April 19, 2012\*

**Appointments:**

- ⊙ Eintracht Braunschweig GmbH & Co KGaA, Braunschweig
- ⊙ Phantoms Basketball Braunschweig GmbH, Braunschweig

**BABETTE FRÖHLICH (48)**

IG Metall,  
Department head for coordination of Executive Board duties and planning  
October 25, 2007\*

**Appointments:**

- MTU Aero Engines AG, Munich

**OLAF LIES (46)**

Minister of Economic Affairs, Labor and Transport for the Federal State of Lower Saxony  
February 19, 2013\*

**Appointments:**

- Deutsche Messe AG, Hanover

**DAVID MCALLISTER (43)**

July 1, 2010 – February 19, 2013\*

**HARTMUT MEINE (61)**

Director of the Lower Saxony and Saxony-Anhalt Regional Office of IG Metall  
December 30, 2008\*

**Appointments:**

- Continental AG, Hanover
- KME Germany GmbH, Osnabrück

**PETER MOSCH (41)**

Chairman of the General Works Council of AUDI AG  
January 18, 2006\*

**Appointments:**

- AUDI AG, Ingolstadt
- Porsche Automobil Holding SE, Stuttgart
- Dr.-Richard-Bruhn-Hilfe, Altersversorgung der AUTO UNION GmbH, VVaG, Ingolstadt

**BERND OSTERLOH (57)**

Chairman of the General and Group Works Councils of Volkswagen AG  
January 1, 2005\*

**Appointments:**

- Autostadt GmbH, Wolfsburg
- Porsche Automobil Holding SE, Stuttgart
- Wolfsburg AG, Wolfsburg
- ⊙ Allianz für die Region GmbH, Braunschweig
- ⊙ Porsche Holding Gesellschaft m.b.H., Salzburg
- ⊙ VfL Wolfsburg-Fußball GmbH, Wolfsburg
- ⊙ Volkswagen Immobilien GmbH, Wolfsburg

**DR. JUR. HANS MICHEL PIÉCH (72)**

Lawyer in private practice  
August 7, 2009\*

**Appointments:**

- AUDI AG, Ingolstadt
- Dr. Ing. h.c. F. Porsche AG, Stuttgart
- Porsche Automobil Holding SE, Stuttgart
- ⊙ Porsche Cars Great Britain Ltd., Reading
- ⊙ Porsche Cars North America Inc., Wilmington
- ⊙ Porsche Gesellschaft m.b.H., Salzburg (Chairman)
- ⊙ Porsche Holding Gesellschaft m.b.H., Salzburg
- ⊙ Porsche Ibérica S.A., Madrid
- ⊙ Porsche Italia S.p.A., Padua
- ⊙ Porsche Piech Holding GmbH, Salzburg (Chairman)
- ⊙ Schmittenhöhebahn AG, Zell am See
- ⊙ Volksooper Wien GmbH, Vienna

**URSULA PIÉCH (57)**

Supervisory Board member of AUDI AG  
April 19, 2012\*

**Appointments:**

- AUDI AG, Ingolstadt

**DR. JUR. FERDINAND OLIVER PORSCHE (52)**

Member of the Board of Management of Familie Porsche AG Beteiligungsgesellschaft  
August 7, 2009\*

**Appointments:**

- AUDI AG, Ingolstadt
- Dr. Ing. h.c. F. Porsche AG, Stuttgart
- Porsche Automobil Holding SE, Stuttgart
- ⊙ PGA S.A., Paris
- ⊙ Porsche Holding Gesellschaft m.b.H., Salzburg
- ⊙ Porsche Lizenz- und Handelsgesellschaft mbH & Co. KG, Bietigheim-Bissingen

○ Membership of statutory supervisory boards in Germany  
● Group appointments to statutory supervisory boards  
⊙ Comparable appointments in Germany and abroad

\* The date signifies the beginning or period of membership of the Supervisory Board.

**DR. RER. COMM. WOLFGANG PORSCHE (70)**

Chairman of the Supervisory Board  
of Porsche Automobil Holding SE;  
Chairman of the Supervisory Board  
of Dr. Ing. h.c. F. Porsche AG  
April 24, 2008\*

**Appointments:**

- AUDI AG, Ingolstadt
- Dr. Ing. h.c. F. Porsche AG, Stuttgart (Chairman)
- Porsche Automobil Holding SE,  
Stuttgart (Chairman)
- ⊙ Familie Porsche AG Beteiligungsgesellschaft,  
Salzburg (Chairman)
- ⊙ Porsche Cars Great Britain Ltd., Reading
- ⊙ Porsche Cars North America Inc., Wilmington
- ⊙ Porsche Gesellschaft m.b.H.,  
Salzburg (Deputy Chairman)
- ⊙ Porsche Holding Gesellschaft m.b.H., Salzburg
- ⊙ Porsche Ibérica S.A., Madrid
- ⊙ Porsche Italia S.p.A., Padua
- ⊙ Porsche Piech Holding GmbH,  
Salzburg (Deputy Chairman)
- ⊙ Schmittenhöhebahn AG, Zell am See

**STEPHAN WEIL (55)**

Minister-President of the Federal State  
of Lower Saxony  
February 19, 2013\*

**STEPHAN WOLF (47)**

Deputy Chairman of the General and  
Group Works Councils of Volkswagen AG  
January 1, 2013\*

**Appointments:**

- Wolfsburg AG, Wolfsburg
- ⊙ Sitech Sitztechnik GmbH, Wolfsburg
- ⊙ Volkswagen Pension Trust e.V.,  
Wolfsburg

**THOMAS ZWIEBLER (48)**

Chairman of the Works Council of  
Volkswagen Commercial Vehicles  
May 15, 2010\*

**COMMITTEES OF THE SUPERVISORY BOARD  
As of December 31, 2013**

**Members of the Executive Committee**

Hon.-Prof. Dr. techn. h.c. Dipl.-Ing. ETH  
Ferdinand K. Piëch (Chairman)  
Berthold Huber (Deputy Chairman)  
Bernd Osterloh  
Dr. Wolfgang Porsche  
Stephan Weil  
Stephan Wolf

**Members of the Mediation Committee in  
accordance with section 27(3) of the  
Mitbestimmungsgesetz (German  
Codetermination Act)**

Hon.-Prof. Dr. techn. h.c. Dipl.-Ing. ETH  
Ferdinand K. Piëch (Chairman)  
Berthold Huber (Deputy Chairman)  
Bernd Osterloh  
Stephan Weil

**Members of the Audit Committee**

Dr. Ferdinand Oliver Porsche (Chairman)  
Peter Mosch (Deputy Chairman)  
Annika Falkengren  
Babette Fröhlich

**Members of the Nomination Committee**

Hon.-Prof. Dr. techn. h.c. Dipl.-Ing. ETH  
Ferdinand K. Piëch (Chairman)  
Dr. Wolfgang Porsche  
Stephan Weil

- Membership of statutory supervisory boards in  
Germany
- Group appointments to statutory supervisory boards
- ⊙ Comparable appointments in Germany and abroad

\* The date signifies the beginning or period of  
membership of the Supervisory Board.

# Disclosures Required Under Takeover Law

In this section, we present the disclosures relating to takeover law required by sections 289(4) and 315(4) of the HGB.

## CAPITAL STRUCTURE

On December 31, 2013, Volkswagen AG's share capital amounted to €1,191,009,251.84 (€1,190,995,445.76); it was composed of 295,089,818 ordinary shares and 170,148,171 preferred shares. This includes 5,393 preferred shares created as a result of the voluntary exercise of the mandatory convertible note. Each share conveys a notional interest of €2.56 in the share capital.

In addition to the issue of the €2.5 billion mandatory convertible note in November 2012, Volkswagen AG successfully placed a further €1.2 billion mandatory convertible note that entitles and obliges holders to subscribe for Volkswagen preferred shares in June 2013 (see also pages 88 and 163).

## SHAREHOLDER RIGHTS AND OBLIGATIONS

The shares convey pecuniary and administrative rights. The pecuniary rights include in particular the shareholders' right to participate in profits (section 58(4) of the Aktiengesetz (AktG – German Stock Corporation Act)), the right to participate in liquidation proceeds (section 271 of the AktG) and preemptive rights to shares in the event of capital increases (section 186 of the AktG) that can be disappplied by the Annual General Meeting with the approval of the Special Meeting of Preferred Shareholders, where appropriate. Administrative rights include the right to attend the Annual General Meeting and the right to speak there, to ask questions, to propose motions and to exercise voting rights. Shareholders can enforce these rights in particular through actions seeking disclosure and actions for avoidance.

Each ordinary share grants the holder one vote at the Annual General Meeting. The Annual General Meeting elects shareholder representatives to the Supervisory Board and elects the auditors; in particular, it resolves the appropriation of net profit, formally approves the actions of the Board of Management and the Supervisory Board, resolves amendments to the Articles of Association, capitalization measures and authorizations to purchase treasury shares; if required, it also resolves the performance of a special audit, the removal before the end of their term of office of Supervisory Board members elected at the Annual General Meeting and the winding-up of the Company.

Preferred shareholders generally have no voting rights. However, in the exceptional case that preferred shareholders are granted voting rights by law (for example, when preferred share dividends were not paid in one year and not compensated for in full in the following year), each preferred share also grants the holder one vote at the Annual General Meeting. Furthermore, preferred shares entitle the holder to a €0.06 higher dividend than ordinary shares (further details on this right to preferred and additional dividends are specified in Article 27(2) of the Articles of Association).

The Gesetz über die Überführung der Anteilsrechte an der Volkswagenwerk Gesellschaft mit beschränkter Haftung in private Hand (VW-Gesetz – Act on the Privatization of Shares of Volkswagenwerk Gesellschaft mit beschränkter Haftung) of July 21, 1960, as amended on July 30, 2009, includes various provisions in derogation of the German Stock Corporation Act, for example on exercising voting rights by proxy (section 3 of the VW-Gesetz) and on majority voting requirements at the Annual General Meeting (section 4(3) of the VW-Gesetz). The European Commission brought an action against Volkswagen at the European Court of Justice (ECJ) because it was of the opinion that this majority requirement does not comply with the Treaty on the Functioning of the European Union (TFEU, formerly the EU Treaty). The ECJ delivered its ruling on October 22, 2013 and dismissed the action brought by the European Commission. The VW-Gesetz, as amended on July 30, 2009, therefore does not need to be amended.

In accordance with the Volkswagen AG Articles of Association (Article 11(1)), the State of Lower Saxony is entitled to appoint two members of the Supervisory Board of Volkswagen AG for as long as it directly or indirectly holds at least 15 percent of Volkswagen AG's ordinary shares. In addition, resolutions by the General Meeting that are required by law to be adopted by a qualified majority require a majority of more than 80 percent of the share capital of the Company represented when the resolution is adopted (Article 25(2)), regardless of the provisions of the VW-Gesetz. The European Commission also considered this provision of the Articles of Association to be incompatible with the TFEU. The ECJ dismissed this complaint in its ruling of October 22, 2013.

**SHAREHOLDINGS EXCEEDING 10% OF VOTING RIGHTS**

Shareholdings in Volkswagen AG that exceed 10% of voting rights are shown in the notes to the annual financial statements of Volkswagen AG and in the notes to the Volkswagen consolidated financial statements starting on pages 272 of this annual report.

**COMPOSITION OF THE SUPERVISORY BOARD**

The Supervisory Board consists of 20 members, half of whom are shareholder representatives. In accordance with Article 11(1) of the Articles of Association, the State of Lower Saxony is entitled to appoint two of these shareholder representatives for as long as it directly or indirectly holds at least 15% of the Company's ordinary shares. The remaining shareholder representatives on the Supervisory Board are elected by the Annual General Meeting.

The other half of the Supervisory Board consists of employee representatives elected by the employees in accordance with the Mitbestimmungsgesetz (MitbestG – German Codetermination Act). A total of seven of these employee representatives are Company employees elected by the workforce; the other three employee representatives are trade union representatives elected by the workforce.

The Chairman of the Supervisory Board is generally a shareholder representative elected by the other members of the Supervisory Board. In the event that a Supervisory Board vote is tied, the Chairman of the Supervisory Board has a casting vote in accordance with the MitbestG.

Information about the composition of the Supervisory Board can be found on pages 66 to 68 of this annual report.

**STATUTORY REQUIREMENTS AND REQUIREMENTS OF THE ARTICLES OF ASSOCIATION WITH REGARD TO THE APPOINTMENT AND REMOVAL OF BOARD OF MANAGEMENT MEMBERS AND TO AMENDMENTS TO THE ARTICLES OF ASSOCIATION**

The appointment and removal of members of the Board of Management are governed by sections 84 and 85 of the AktG, which specify that members of the Board of Management are appointed by the Supervisory Board for a maximum of five years. Board of Management members may be reappointed or have their term of office extended for a maximum of five years in each case. In addition, Article 6 of the Articles of Association states that the number of Board of Management members is stipulated by the Supervisory Board and that the Board of Management must consist of at least three persons.

The Annual General Meeting resolves amendments to the Articles of Association (section 119(1) of the AktG). In accordance with section 4(3) of the VW-Gesetz as amended on July 30, 2009 and Article 25(2) of the Articles of Association, Annual General Meeting resolutions to amend the Articles of Association require a majority of more than four-fifths of the share capital represented.

**POWERS OF THE BOARD OF MANAGEMENT, IN PARTICULAR CONCERNING THE ISSUE OF NEW SHARES AND THE REPURCHASE OF TREASURY SHARES**

According to German stock corporation law, the Annual General Meeting can, for a maximum of five years, authorize the Board of Management to issue new shares. It can also authorize the Board of Management, for a maximum of five years, to issue bonds on the basis of which new shares are to be issued. The Annual General Meeting also decides the extent to which shareholders have preemptive rights to the new shares or bonds. The highest amount of authorized share capital or contingent capital available for these purposes is determined by Article 4 of the Articles of Association of Volkswagen AG, as amended.

The Annual General Meeting on April 19, 2012 resolved to authorize the Board of Management, with the consent of the Supervisory Board, to increase the Company's share capital by a total of up to €110.0 million (corresponding to approximately 43 million shares) on one or more occasions up to April 18, 2017 by issuing new ordinary and/or nonvoting preferred bearer shares – including with shareholders' preemptive rights disappplied – against cash and/or noncash contributions. Additionally, the Board of Management is authorized to increase the share capital by up to a total of €179.4 million on one or more occasions up to December 2, 2014 by issuing new nonvoting preferred shares against cash contributions. Furthermore, the share capital can be increased by up to €102.4 million by issuing nonvoting preferred shares, in order to settle the conversion or option rights of holders or creditors of convertible bonds or bonds with warrants to be issued before April 21, 2015. This authorization was partially exercised in November 2012 by the issuance of a mandatory convertible note in the amount of €2.5 billion and in June 2013 by a further mandatory convertible note in the amount of €1.2 billion. Further details on the authorization to issue new shares and their permitted uses may be found in the notes to the consolidated financial statements on page 228.

Opportunities to acquire treasury shares are governed by section 71 of the AktG. The Board of Management was most recently

authorized to acquire treasury shares up to a maximum of 10% of the share capital at the Annual General Meeting on April 19, 2012. This authorization applies until April 18, 2017 and has not so far been exercised.

**MATERIAL AGREEMENTS OF THE PARENT COMPANY IN THE EVENT OF A CHANGE OF CONTROL FOLLOWING A TAKEOVER BID**

A banking syndicate granted Volkswagen AG a syndicated credit line amounting to approximately €5.0 billion that runs until July 2018.

The syndicate members were granted the right to call their portion of the syndicated credit line if Volkswagen AG is merged with a third party or becomes a subsidiary of another company. However, this call right does not apply in the event of a merger by absorption of Porsche Holding SE, one of its subsidiaries, or one of its holding companies and Volkswagen AG in which Volkswagen AG is the acquiring legal entity.

**RESTRICTIONS ON THE TRANSFER OF SHARES**

Volkswagen AG and Suzuki Motor Corporation have agreed mutual approval and preemptive tender rights if the shares held by the other contracting party are to be sold. As of the reporting date, Volkswagen held a 19.9% stake in Suzuki.

# Business Development

The global economy recorded only moderate growth in fiscal year 2013. Global demand for vehicles registered slower growth than in the previous year. The Volkswagen Group increased its deliveries to customers by 4.9% year-on-year, amid difficult market conditions.

## GLOBAL ECONOMY STILL LACKS MOMENTUM

Global economic growth in the reporting period was down on the previous year's level, at 2.5% (2.6%). The economic situation in the industrialized nations improved slightly in the course of the year despite the continued presence of structural obstacles. Most emerging economies recorded robust economic growth. Inflation was moderate despite the expansionary monetary policies of many central banks.

### Europe/Remaining markets

In Western Europe, GDP stagnated after declining by 0.3% in the previous year. Most Southern European EU countries again recorded negative growth rates in the reporting period due to the negative effects of the sovereign debt crisis, among other things. By contrast, growth rates were positive in most Northern European countries. The overall unemployment rate in Europe continued to rise, reaching 12.6% (11.8%). Unemployment in Greece, Portugal, Spain and Cyprus was well above this average.

In Central and Eastern Europe, GDP growth declined to an average of 2.1% (2.4%), primarily due to the muted growth in Russia of 1.6% (3.4%).

At 1.8%, South Africa's economic growth was down on the prior-year level of 2.5%.

### Germany

The positive consumer sentiment and stable situation in the labor market were unable to cushion the impact of the weaker global economic trend on the German economy in 2013. At 0.5%, Germany's GDP growth was down year-on-year (0.9%).

### North America

In the USA, the rate of economic expansion was lower than in 2012, at 1.9% (2.8%), despite a positive consumer climate and declining unemployment. The US dollar was volatile against the euro during the period and was lower at the end of the year. Canada's GDP rose by 1.7% (1.7%) and the Mexican economy expanded by just 1.3% (3.9%).

### South America

Brazil's growth rate recovered to reach 2.3% (1.0%), while GDP growth rose sharply to 4.9% in Argentina (1.9%). The economic situation in both countries was marred by structural deficits and high rates of inflation.

### Asia-Pacific

At 7.7% (7.7%), China's economic growth was above the central government's target rate of 7.5%. Economic growth reached 5.0% (5.1%) in India and was curbed by structural problems and considerable price increases. In Japan, the monetary and fiscal policy measures and the devaluation of the yen saw economic growth stabilizing at 1.7% (1.4%).



**ECONOMIC GROWTH**  
Percentage change in GDP

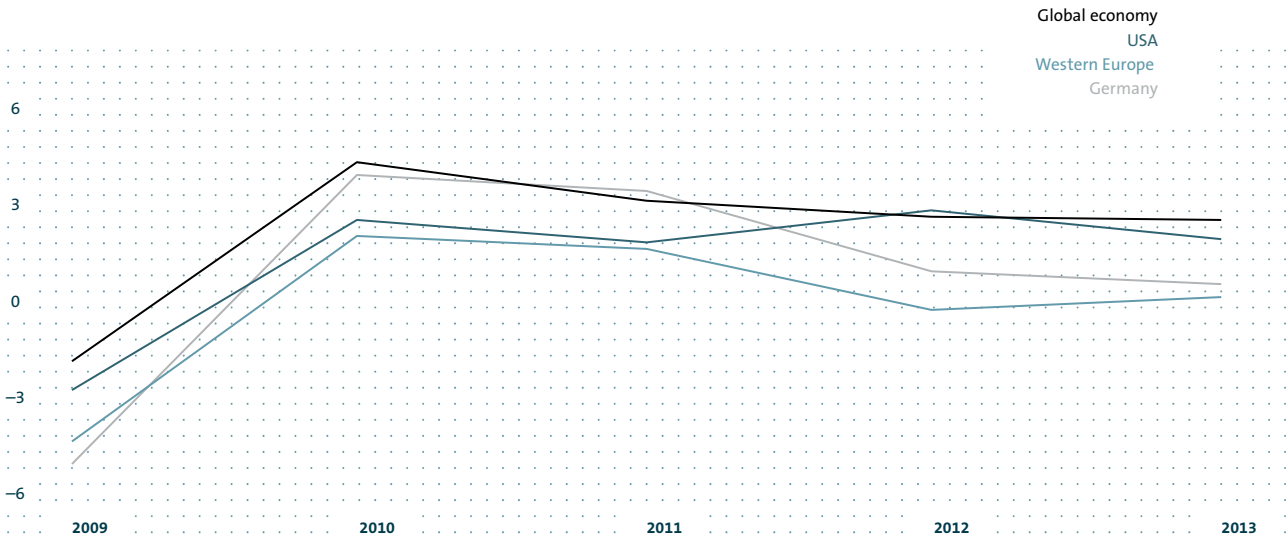

**GLOBAL NEW PASSENGER CAR REGISTRATIONS REACH RECORD HIGH**

Global demand for passenger cars increased by 5.0% to 70.1 million vehicles in 2013, exceeding the previous year's record level. This development was driven by the rapid growth in China and the NAFTA region in particular. Global passenger car production rose by 5.6% to 74.6 million units in the reporting period.

**Sector-specific environment**

The established passenger car markets turned in a very mixed performance in fiscal year 2013. While some industrialized countries were still negatively affected by the debt crisis and its repercussions, demand remained robust in certain growth markets.

The continued development of the major markets in China and Brazil, the expansion of activities in India and the ASEAN region and an increasing presence in Russia are still highly important for the automotive industry.

Trade restrictions have been reduced in many Asian and African markets. However, it cannot be ruled out that these countries will fall back on protectionist measures in the event of another global economic slump.

**Europe/Remaining markets**

In Western Europe, new registrations in the reporting period were even lower than in the previous year. Demand reached its lowest level for 20 years, at 11.5 million vehicles (-1.9%). However, the passenger car markets that were most affected by the debt crisis stabilized at a low level in the second half of the year. Demand declined year-on-year in the volume markets of France (-5.6%) and Italy (-7.1%). In Spain, a further decline in new registrations was prevented (+3.3%) by government incentive programs. Sustained high demand from private customers in the United Kingdom led to market growth of 10.7%. At 53.1%, the market share of diesel vehicles (passenger cars) in Western Europe was down on the prior-year figure in fiscal year 2013.

In Central and Eastern Europe, demand decreased by 3.9% to 3.8 million vehicles. In Russia, by far the region's largest passenger car market, the government car loan subsidies introduced on July 1, 2013 were unable to stop the decline in demand: this decreased by 5.7% to 2.6 million vehicles. Passenger car sales were pushed down by the new extra duty on imported cars. At 0.8 million passenger cars, the Central European EU states recorded an overall market volume on a level with the previous year.

EXCHANGE RATE MOVEMENTS FROM DECEMBER 2012 TO DECEMBER 2013

Index based on month-end prices: December 31, 2012=100

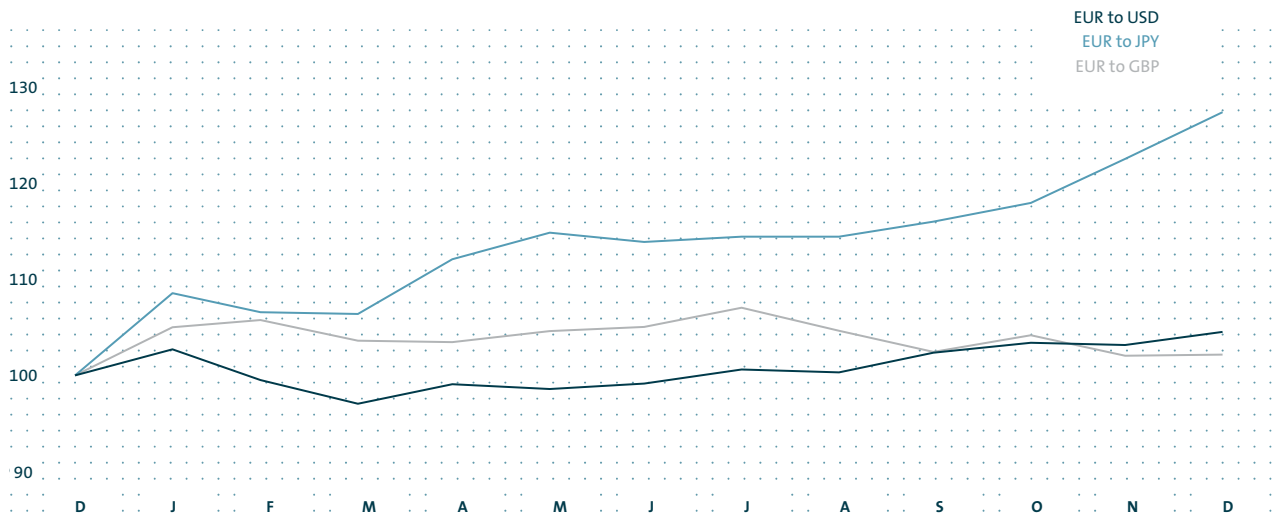

In Turkey, sales reached a new peak of 643 thousand vehicles (+15.7%) in 2013, largely due to the sharp rise in the number of imported vehicles.

Sales in the South African market rose for the fourth consecutive year. New registrations increased by 3.4% to 455 thousand units in the reporting period, primarily due to the relatively low interest rates and manufacturer and dealer incentives.

#### Germany

Passenger car demand in Germany was even lower than in the previous year at 3.0 million units (-4.2%). This represents the second-lowest level since German reunification. However, the first signs of stabilization started to emerge in the fourth quarter. Despite the positive consumer sentiment, customers were reluctant to buy new cars. By contrast, demand for used cars rose. Both domestic passenger car production (+1.0% to 5.4 million vehicles) and passenger car exports (+1.6% to 4.2 million units) were up slightly year-on-year, however, and exceeded the comparable average figures for the past ten years.

#### North America

In the North America region, demand for passenger cars and light commercial vehicles (up to 6.35 tonnes) rose sharply in fiscal 2013. The North American market registered its highest volumes since 2007, with a rise of 7.3% to 18.4 million vehicles. In the USA, the overall market volume increased by 7.7% to 15.6 million units, largely thanks to the favorable financing conditions offered by manufacturers and higher replacement demand. In Canada,

demand rose by 4.0% to a new record of 1.7 million vehicles. The Mexican market exceeded the 1 million new registrations mark last reached in 2008, posting a rise of 7.7% to 1.1 million units.

#### South America

In South America, the number of new passenger car registrations fell just slightly below the prior year's high level. At 2.8 million units, demand in Brazil was 3.1% short of the record level achieved in 2012. The market continued to be buoyed up by government tax incentives, but their effect had been much stronger in the previous year. The proportion of new registrations accounted for by imported passenger cars declined to 17.0% (18.8%). In contrast, at 563 thousand units, Brazil's own vehicle exports were up by a significant 26.5%.

In Argentina, demand for passenger cars rose by 8.9% in fiscal year 2013 to a record high of 640 thousand units. The country's high inflation means that consumers are investing more in tangible assets.

#### Asia-Pacific

The Asia-Pacific region registered market growth of 8.6% in fiscal year 2013, reaching a new peak of 28.0 million units. This growth was mainly driven by the Chinese passenger car market, which achieved double-digit growth for the first time since 2010, rising 17.0% to 15.8 million vehicles. The unexpectedly strong growth was bolstered in particular by China's robust macroeconomic environment, a large number of new passenger car models and the still comparatively low passenger car density.

The Indian passenger car market registered a year-on-year decline for the first time since 2001, decreasing by 6.7% to 2.4 million units. In addition to the weaker economic environment, this downward trend was mainly due to the still high financing costs and higher fuel prices.

In Japan, the number of new vehicle registrations remained at the previous year's level, with an overall market volume of 4.6 million vehicles (-0.1%). The encouraging performance of the Japanese economy positively impacted the vehicle market. In 2012, the Japanese market had continued to be buoyed by the significant pent-up demand resulting from the natural disasters in 2011 and government stimulus measures.

#### DEMAND FOR COMMERCIAL VEHICLES MIXED

Overall, demand for light commercial vehicles was slightly higher in fiscal year 2013 than in 2012. A total of 11.8 million vehicles were sold worldwide, representing an increase of 0.6% on the previous year.

There was a slight decline in demand in Western Europe, as the economy was still weak due to the ongoing sovereign debt crisis. At a total of 1.3 million vehicles sold, vehicle sales were down 3.2% compared with the previous year. Most markets in Western Europe fell slightly short of their prior-year figures. However, the UK market benefited from an improved macroeconomic trend.

In Central and Eastern Europe, demand declined slightly overall as against the 2012 level. 326 thousand (335 thousand) vehicles were sold in the reporting period. While individual markets such as Poland and Slovenia grew over the course of the reporting period, Russia's downward trend in demand accelerated at the end of the year.

The North American market saw a significant rise in unit sales to 9.2 million (8.3 million) vehicles in the reporting period, with higher demand for pickups and SUVs in particular.

Vehicle sales in South America increased overall in 2013. At 1.3 million units, 7.3% more light commercial vehicles were sold than in the previous year. The growing popularity of SUVs for private use, which are reported as light commercial vehicles in these markets, was the main driver of this, despite the weak economic conditions. Particularly in Argentina, where many customers increasingly invested in tangible assets prompted by the high inflation, the market for light commercial vehicles grew significantly in the reporting period.

At 7.9 million (+0.6%), vehicle sales in the Asia-Pacific region were on a level with the previous year in the fiscal year 2013. The Chinese market, which dominates the region, returned to a slight growth path during the reporting period, after stagnating in the previous year. A total of 5.1 million (5.0 million) units were sold there. In Japan, the expansionary economic policy gave the light commercial vehicle market a moderate lift. Sales in India fell short of the prior-year level, declining by 10.0% to 600 thousand units

due to higher fuel prices, among other factors. Sales figures were higher year-on-year in most markets of the ASEAN region thanks to positive economic developments.

Demand for mid-sized and heavy trucks with a gross weight of more than six tonnes was up slightly year-on-year in the fiscal year 2013. A total of 2.7 million vehicles were sold worldwide, representing a slight increase of 2.5%.

In Western Europe, vehicle sales increased by 5.7% compared with the previous year and totaled 248 thousand units. The negative effects of the still unresolved debt crisis in the eurozone were more than offset by purchases pulled forward ahead of the introduction of the Euro 6 emission standard on January 1, 2014.

At 164 thousand vehicles, new registrations in Central and Eastern Europe in 2013 were 5.5% below the comparable prior-year figure. In Russia, the largest market, the sales figures declined by 14.0% to 103 thousand units. The introduction of the recycling fee on imported vehicles in September 2012 and the negative oil price trend played a large part in this decline. In addition, the lower commodity prices had a negative effect on Russia's state finances, which the government responded to by cutting infrastructure projects.

At 435 thousand vehicles, sales of mid-sized and heavy trucks (more than 6.35 tonnes) in North America remained at the prior-year level (433 thousand). The US market, which was heavily impacted by companies' reluctance to invest, accounted for 351 thousand (346 thousand) of these vehicles.

At 234 thousand (231 thousand) units, sales in South America were above the previous year's level. In Brazil, in particular, the higher transportation demand due to the bumper harvest and favorable financing conditions for trucks had a significant impact. New registrations in the country increased by 12.4% to 149 thousand vehicles.

Excluding the Chinese market, the volume of vehicles sold in the Asia-Pacific region was significantly lower than in the previous year. New registrations amounted to 448 thousand (539 thousand) vehicles. This decline is attributable in particular to the slump in unit sales in India, caused by the weaker macroeconomic situation. Sales of mid-sized and heavy trucks in India were 30.7% lower year-on-year, at 184 thousand units. In China, the world's largest truck market, total demand amounted to 1.1 million units in the fiscal year 2013, 14.8% more than in the previous year. This increase was largely attributable to the improved domestic economy and the investments made ahead of the introduction of new emission standards in 2014.

Global demand for buses was on a level with the previous year in fiscal year 2013. Demand for buses also stagnated at the 2012 level in Western Europe, where the negative effects of the sovereign debt crisis were offset by purchases pulled forward due to the introduction of the Euro 6 standard.

#### TRENDS IN THE MARKETS FOR POWER ENGINEERING

The markets for power engineering are subject to differing regional and economic influences. Consequently, their business growth trends are generally independent of each other.

The merchant shipbuilding market is still dominated by significant overcapacity in the merchant fleet. Despite declining in the reporting period, deliveries remained at a high level. Rising fuel and operating costs caused mounting cost pressure for shipping company owners. At the same time, the excess capacities at shipyards kept the price of constructing new ships low. This situation led to a slight rise in orders in 2013, including for extremely large ships, which make it possible to reduce the price per unit shipped. Demand for offshore and special ships remained high in the reporting period. Due to the still high price of oil, orders were received for supply and construction vessels for developing new reserves. Demand for tankers for transporting liquid natural gas (LNG) and for cruise ships also remained high. The special market for government vessels also continued to perform well.

The market for decentralized diesel and gas engine power plants slowed down slightly in 2013, although growth was still high. This was attributable to the economic situation in the emerging markets, which deteriorated at the start of the year. In addition, the more difficult financing conditions led to longer project lead times. While there was a further slowdown in orders for diesel and oil fired power plants, demand for power plants with gas engines and dual-fuel engines (which can run on both liquid fuel and natural gas) was relatively stable. This shift in demand reflects the trend towards natural gas power plants.

There was a slight decline in the reporting period in orders from industrial facilities where compressors and turbines, turbo gear units and slide bearings are used. Although the growing demand for energy and primary materials meant that there was a significant investment requirement in this market and interest from customers remained high, economic uncertainties and difficult financing conditions caused order placement delays. Oil and gas investments remained high in 2013 due to the rise in oil prices. Price pressure rose sharply, with the yen's devaluation giving Japanese competitors an advantage.

The development of offshore wind energy again fell well short of the original market expectations in 2013. This was largely attributable to the ongoing technical problems, particularly in relation to infrastructure, and the limited financing options.

#### DEMAND FOR FINANCIAL SERVICES

Global demand for automotive-related financial services remained high in fiscal year 2013. Customers are increasingly optimizing their total spend on mobility, so the trend toward just using a car, rather than actually buying one, continued. New mobility services such as car sharing are thus gaining in importance.

In the difficult economic environment, particularly in Southern Europe, providers stepped up their business activities in 2013 and developed attractive, customer-oriented campaigns.

Despite declining new passenger car registrations, the finance and leasing business grew in Germany. Alongside traditional finance products, there was also higher demand for packaged products including insurance and service.

In North America, demand for financial services rose again. In the USA, the market for new vehicle financing registered slower growth, while the market for leasing through captive financial service providers grew sharply. Demand for financial services also continued to rise in Mexico. This was primarily attributable to the stable lending conditions and interest rates, as well as growing interest in modular mobility products.

The strong growth seen in Brazil in recent years weakened in 2013. However, this trend was countered through special campaigns to bolster lending to private customers. In particular, the sustained demand for car ownership was supported through the sales of *Consortio*, a lottery-style financing product. The high inflation in Argentina continued to have a positive impact on sales volumes for automotive-related financial services.

The macroeconomic situation in the Asia-Pacific region was characterized by stability and growth in 2013, which was reflected in the demand for automotive-related financial services. In China, the proportion of loan-financed vehicle purchases increased from 15% in 2012 to more than 20% in 2013. There is still significant potential to acquire new customers for automotive-related financial services. The Japanese market benefited from stable demand. India, South Korea and Australia also registered sustained growth in demand for automotive-related financial services.

The financial services market in the commercial vehicles segment also saw a trend towards optimizing total costs in the mid-sized and heavy commercial vehicle category. Innovative transportation solutions are becoming increasingly important to customers as a point of difference. More intense competition was seen in the commercial finance market in Germany and, increasingly, in Europe as a whole due to the interest rate developments.

#### NEW GROUP MODELS IN 2013

The Volkswagen Group selectively expanded its model portfolio in key segments in the reporting period. Additionally, we introduced new products based on the Modular Transverse Toolkit (MQB), which we launched in 2012. This will also form the basis for many other new models in the coming years. The Group's range now comprises around 315 passenger car, commercial vehicle and motorcycle models and their derivatives. The Group covers almost all key segments and body types, with offerings from small cars to super sports cars in the passenger car sector, and from pickups to heavy trucks and buses in the commercial vehicles sector, as well as motorcycles. We will continue to resolutely move into unoccupied market segments that offer profitable opportunities for us.

The models premiered by the Volkswagen Passenger Cars brand in the past year included the dynamic Golf derivatives GTD, GTI, Golf R and Golf R Cabriolet, as well as the efficiency models Golf BlueTDI and the Golf BlueMotion, which uses just 3.2 liters of fuel per 100 km. In addition, the new Golf estate was launched on the market. At 1,620 liters, its boot capacity exceeds its predecessor's by 125 liters. The new Beetle Convertible and cross up! further strengthened the brand image. The e-up!, the first vehicle developed by the Volkswagen Group to run on electrical power alone, heralded a new era for e-mobility. Volkswagen took account of special customer and market requirements in key regions outside Europe through product upgrades and country-specific models. The successor to the best-selling Jetta was launched on the Chinese market in fiscal year 2013. We also moved into additional volume and niche segments with the new Gran Lavana and the dynamic Sagitar GLE. In Brazil, we unveiled the Gol Rallye, a derivative of the most popular model on the market. A BlueMotion version of the compact Fox was also introduced.

The Audi brand once again proved its technical and sporting credentials in 2013. In the premium compact segment, after starting production of the Audi A3 as the Group's first vehicle based on the MQB in 2012, Audi expanded the A3 range in the reporting period to include the S3 Sportback and the natural gas-powered A3 g-tron. Audi also presented its first A3 notchback model, which boasts dynamic contours and coupé-like lightness. The flagship A8 and R8 and the Q5 were also upgraded. In the American market, the brand extended its TDI offensive to the A6, A7, A8 and Q5 models. Audi also strengthened its market position in China with its fourth locally manufactured model, the Q3.

Following the presentation of the compact Rapid notchback saloon in 2012, in 2013 ŠKODA unveiled the Rapid Spaceback – a

new compact that offers all the space expected from ŠKODA together with a fresh and elegant design. ŠKODA also unveiled the brand's first MQB model, the new Octavia, which is available as a saloon and an estate. The series spearhead is the newly launched Octavia RS – the fastest ever Octavia. The Superb was also upgraded. In 2013, ŠKODA also started producing the Yeti in China, catering to the specific requirements of Chinese customers (for example, it has a longer wheelbase).

Spanish brand SEAT expanded the Leon Family in 2013 with the three-door Leon SC and the sporty Leon ST estate. Both cars are based on the MQB.

Porsche emphasized its dominance of the global premium and sports segment with a number of new models in the reporting period. The new edition of the 911 series took center stage, and other new exciting cars were added to the range. The brand also debuted a special edition to mark the fiftieth anniversary of the 911. In addition, the mid-engine Cayman was updated. The Panamera series was also updated and now offers the first plug-in hybrid in the luxury class in the shape of the Panamera S E-Hybrid.

The Group's luxury brands also premiered new models in 2013. Bentley presented the successor to the Flying Spur and the new Continental GTC Speed Convertible for the first time. Lamborghini launched the Aventador Roadster, the successor to the Murciélago Roadster super sports car.

Volkswagen Commercial Vehicles started production of the new Caddy BlueMotion in the reporting period. Consuming just 4.5 liters of diesel per 100 km, it is the most economical Caddy ever made. A fuel-efficient BlueMotion version of the Crafter has also been available since 2013. Volkswagen Commercial Vehicles also launched the special-edition Amarok Canyon to appeal to pickup customers with high-octane lifestyles.

In 2013, Scania expanded its range of Euro 6 engines, which now includes gas and biodiesel engines. Scania also presented the redesigned G- and R-series as Euro 6 models with an improved look and better aerodynamics.

MAN introduced the new generation of Euro 6 engines across all of its model series in 2013, including the entire bus portfolio. At the world's largest solar power plant, which officially went into operation in Abu Dhabi in March 2013, a MAN steam turbine generates enough environmentally friendly electricity to power around 57,000 German homes.

At Ducati, product highlights included the new Hypermotard SP, Multistrada 1200 S Granturismo and Superbike 899 Panigale models.

**VOLKSWAGEN GROUP DELIVERIES BY MONTH**

Vehicles in thousands

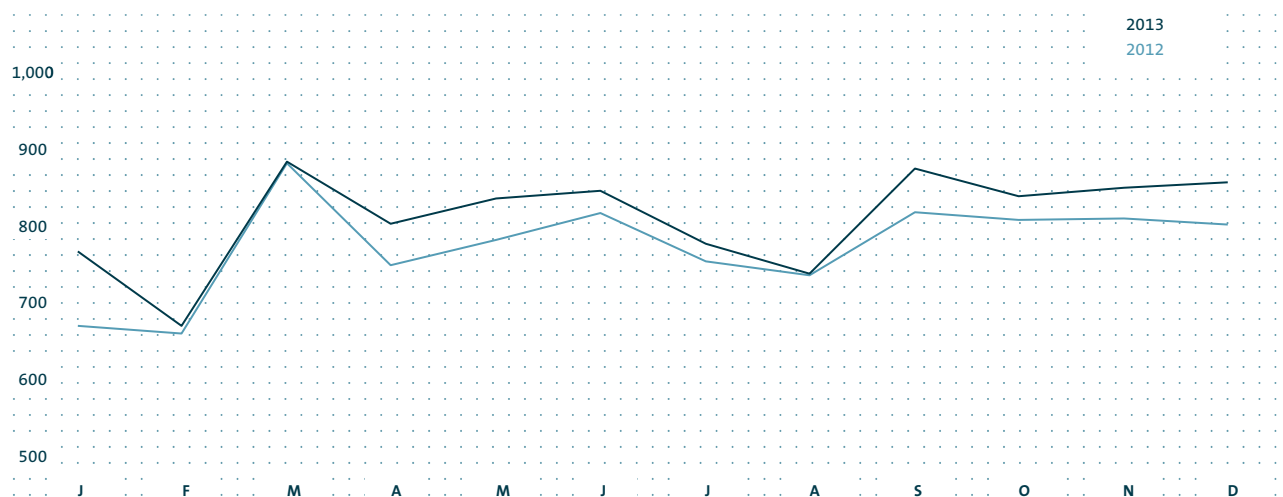

**VOLKSWAGEN GROUP DELIVERIES**

The Volkswagen Group delivered 9,730,680 vehicles to customers worldwide in fiscal year 2013, exceeding the record prior-year level by 4.9%. The chart on this page shows that the delivery figures were higher in all twelve months of the reporting period than in the same months of 2012. Details of deliveries of passenger cars and commercial vehicles are provided separately in the following. Since January 1, 2013, the Volkswagen Commercial Vehicles brand has been reported under commercial vehicles together with Scania and MAN. The prior-year figures were adjusted accordingly.

**VOLKSWAGEN GROUP DELIVERIES\***

	2013	2012
Passenger cars	8,957,975	8,523,881
Commercial vehicles	772,705	751,802
<b>Total</b>	<b>9,730,680</b>	<b>9,275,683</b>

\* Deliveries for 2012 have been updated and adjusted to reflect subsequent statistical trends and the new reporting structure.

**PASSENGER CAR DELIVERIES**

With its brands, the Volkswagen Group has a presence in all relevant automotive markets around the world. Western Europe, China, Brazil, the USA, Russia, Mexico and Argentina are currently the key sales markets for the Group. The Group maintained its strong competitive position in the reporting period thanks to its wide range of attractive and environmentally friendly models. We again recorded an encouraging increase in demand in key core markets.

In fiscal year 2013, the Volkswagen Group delivered 8,957,975 passenger cars to customers, exceeding the record prior-year level. The rise of 5.1% was ahead of growth in the passenger car market as a whole, which amounted to 5.0% in the same period. The Group's share of the global market was 12.8% (12.8%). Since August 1, 2012, the Group's delivery figures also include Porsche brand vehicles. The Volkswagen Passenger Cars, Audi and Bentley brands recorded their best ever delivery figures in the year under review. Demand for Volkswagen Group passenger cars grew fastest in the Asia-Pacific region.

The table on page 80 gives an overview of deliveries to customers in the different markets of the Volkswagen Group. We describe the demand trends for Group models in the individual markets in the following sections.

**WORLDWIDE DELIVERIES OF THE GROUP'S MOST SUCCESSFUL MODELS IN 2013**

*Vehicles in thousands*

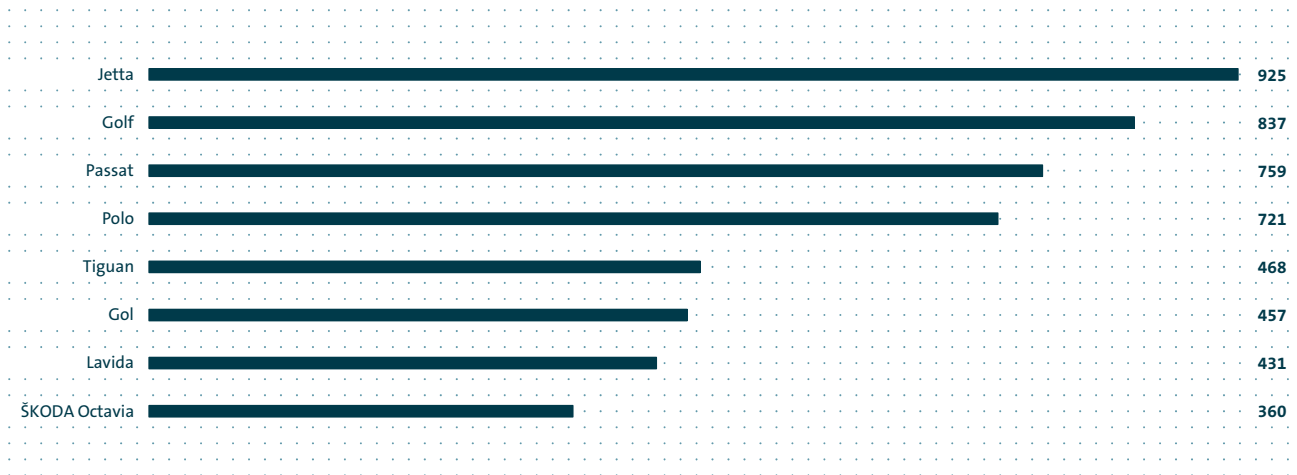

**Deliveries in Europe/Remaining markets**

In Western Europe, the market as a whole declined by 1.9% year-on-year. The Group's sales figures were down year-on-year in all major markets in this region, apart from the United Kingdom and Spain. Overall, we delivered 2,734,534 units (-0.2%) to customers – almost as many as in 2012 – and thus performed better than the market as a whole. The up!, Golf, Audi A3, Audi Q5, SEAT Leon and ŠKODA Octavia were among the models to see increases. The Group's share of the passenger car market in Western Europe rose to 24.8% (24.4%).

In the reporting period, our sales in Central and Eastern Europe almost reached the prior-year level (-0.6%). This means that we also outperformed the market as a whole in this region (-3.9%). While deliveries in Russia declined, sales were up in Poland, the Czech Republic and Hungary. Demand for the Polo Sedan, Golf, Jetta, Audi A3, Audi Q3, Audi Q5, SEAT Leon and ŠKODA Citigo models developed positively. The Group's share of the passenger car market in Central and Eastern Europe rose to 15.7% (15.2%).

The number of deliveries made to Volkswagen Group's customers in South Africa surpassed the prior-year level by 5.2%. The Polo remained the most sought-after Group model.

Demand for Group vehicles in the Middle East region grew by 21.8% compared with the previous year. The Polo, Golf, Jetta and Passat models were particularly popular.

**Deliveries in Germany**

The number of Group deliveries to customers in the German passenger car market remained on a level with the previous year (-0.8%). The market as a whole declined by 4.2% in the same

period. The Golf, Tiguan, Audi A3, Audi Q5, SEAT Leon and ŠKODA Octavia models were particularly popular. Six Volkswagen Group models led the Kraftfahrt-Bundesamt (KBA – German Federal Motor Transport Authority) registration statistics in their respective segments at the end of 2013: the up!, Polo, Golf, Passat, Touran and Tiguan. The Golf continues to be the most popular passenger car in Germany in terms of registrations.

**Deliveries in North America**

In 2013, the Volkswagen Group sold 2.6% more vehicles in the US market than in the previous year. The Jetta, Passat, Audi A4, Audi Q5 and Audi A6 models were particularly popular. The Porsche 911 and Cayenne models were also in demand. We delivered 8.0% more vehicles in Canada than in 2012. The Jetta was the most sought-after Group model. In Mexico, we handed over 14.7% more vehicles to customers in the reporting period than in the previous year. Demand increased for the Golf, Jetta, Passat, Audi Q3 and Audi A4 models. The Volkswagen Group's overall market share in the North American passenger car market was 4.8% (4.9%).

**Deliveries in South America**

In the year under review, we delivered 13.3% fewer vehicles to customers in the highly competitive South American markets than in the prior year. The Volkswagen Group's share of the passenger car market in this region decreased to 17.0% (19.5%) overall.

Our sales declined by 16.2% in the Brazilian market. However, the Tiguan, Audi A3 and Audi Q3 models were among those to record positive growth. The Gol is still the bestselling model in South America.

The Volkswagen Group's deliveries in Argentina were on a level with the previous year in 2013. The Gol remained very popular and demand for the Jetta grew significantly.

#### Deliveries in the Asia-Pacific region

Our passenger car sales in the Asia-Pacific region increased by 14.8% in 2013. We thus outperformed the market as a whole, which grew by 8.6% in the same period. The Group increased its share of the passenger car market in the Asia-Pacific region to 12.9% (12.2%). We delivered 16.2% more vehicles year-on-year to

customers in the Chinese market, which was again the main driver of growth in the Asia-Pacific region. The Sagitar, Lavida, Tiguan, Santana, Passat, Audi A4, Audi Q5 and Audi A6 models recorded significant increases. Demand for the Porsche Cayenne was also strong.

In Japan, we handed over 22.5% more vehicles to customers in the year under review than in the previous year; the market as a whole declined by 0.1%. Sales in India were down 18.9% year-on-year in a declining market.

#### PASSENGER CAR DELIVERIES TO CUSTOMER BY MARKET<sup>1</sup>

	DELIVERIES (UNITS)		CHANGE
	2013	2012 <sup>2</sup>	(%)
<b>Europe/Remaining markets</b>	<b>3,715,298</b>	<b>3,677,682</b>	<b>+ 1.0</b>
<b>Western Europe</b>	<b>2,734,534</b>	<b>2,739,082</b>	<b>-0.2</b>
of which: Germany	1,044,477	1,052,400	-0.8
United Kingdom	454,400	399,388	+ 13.8
France	245,926	263,317	-6.6
Italy	176,231	188,323	-6.4
Spain	173,893	169,017	+ 2.9
<b>Central and Eastern Europe</b>	<b>599,265</b>	<b>602,665</b>	<b>-0.6</b>
of which: Russia	287,264	301,574	-4.7
Czech Republic	83,215	80,826	+ 3.0
Poland	75,920	68,972	+ 10.1
<b>Remaining markets</b>	<b>381,499</b>	<b>335,935</b>	<b>+ 13.6</b>
of which: Turkey	126,853	97,764	+ 29.8
South Africa	103,720	98,606	+ 5.2
<b>North America</b>	<b>878,923</b>	<b>833,624</b>	<b>+ 5.4</b>
of which: USA	611,747	596,078	+ 2.6
Mexico	180,123	156,974	+ 14.7
Canada	87,053	80,572	+ 8.0
<b>South America</b>	<b>747,542</b>	<b>861,956</b>	<b>-13.3</b>
of which: Brazil	558,317	666,578	-16.2
Argentina	148,979	148,955	+ 0.0
<b>Asia-Pacific</b>	<b>3,616,212</b>	<b>3,150,619</b>	<b>+ 14.8</b>
of which: China	3,266,235	2,809,689	+ 16.2
Japan	100,535	82,078	+ 22.5
India	92,561	114,084	-18.9
<b>Worldwide</b>	<b>8,957,975</b>	<b>8,523,881</b>	<b>+ 5.1</b>
Volkswagen Passenger Cars	5,932,308	5,738,417	+ 3.4
Audi	1,575,480	1,455,123	+ 8.3
ŠKODA	920,750	939,202	-2.0
SEAT	355,004	321,002	+ 10.6
Bentley	10,120	8,510	+ 18.9
Lamborghini	2,121	2,083	+ 1.8
Porsche	162,145	59,513	x
Bugatti	47	31	+ 51.6

1 Deliveries for 2012 have been updated and adjusted to reflect subsequent statistical trends and the new reporting structure. The figures include the Chinese joint venture companies.

2 The Porsche brand's deliveries are included as from August 1, 2012.



#### COMMERCIAL VEHICLE DELIVERIES

In fiscal year 2013, the Volkswagen Group delivered 772,705 light commercial vehicles, trucks and buses to customers worldwide (+2.8%), of which 551,908 were light commercial vehicles (+0.3%). The number of trucks sold rose to 198,004 (+10.0%), while deliveries of buses increased to 22,793 (+5.3%). Volkswagen Commercial Vehicles sold 0.3% more units than in 2012, reaching a new record. The MAN brand delivered 140,333 units in the reporting period, an increase of 4.5% on the previous year. Scania significantly increased deliveries by 19.4% year-on-year to 80,464 units.

In Western Europe, the Volkswagen Group's deliveries were on a level with the previous year (-1.0%) at a total of 349,204 units, of which 274,173 units were light commercial vehicles and 71,314 were trucks. While the pull-forward effects related to the introduction of the Euro 6 emission standard had a positive impact, the still unresolved eurozone debt crisis and high competitive pressure negatively affected demand.

We delivered 69,171 vehicles in Central and Eastern Europe, matching the prior-year level. Light commercial vehicles accounted for 40,271 of this figure, trucks for 27,544 and buses for 1,356. Demand for the Amarok was higher than in the previous year. The

decline in sales in Russia, the region's largest market, was mainly due to the introduction of the recycling fee on imported vehicles in September 2012 and the negative oil price trend.

In the Remaining markets, the Volkswagen Group sold 67,525 (70,263) vehicles, of which 47,047 units were light commercial vehicles and 18,130 were trucks.

During the reporting period, we delivered 9,855 light commercial vehicles, 280 trucks and 1,503 buses in the North American markets. Overall, we increased our sales by 19.9%.

In South America, 244,720 vehicles were delivered to customers (+11.3%), of which 160,409 units were light commercial vehicles and 72,296 were trucks. Growth rates for the Saveiro and Amarok models were encouraging. In the Brazilian market, the higher transportation demand due to the bumper harvest and favorable financing conditions had a positive impact. We delivered a total of 123,904 light commercial vehicles, 62,879 trucks and 10,099 buses in Brazil.

In the markets of the Asia-Pacific region, we increased sales to the Group's customers by 1.8% to a total of 30,447 units, of which 20,153 were light commercial vehicles and 8,440 were trucks. We delivered 2,489 light commercial vehicles, 2,189 trucks and 190 buses in the Chinese market.

#### COMMERCIAL VEHICLE DELIVERIES TO CUSTOMERS BY MARKET\*

	DELIVERIES (UNITS)		CHANGE
	2013	2012	(%)
<b>Europe/Remaining markets</b>	<b>485,900</b>	<b>492,281</b>	<b>-1.3</b>
Western Europe	349,204	352,834	-1.0
Central and Eastern Europe	69,171	69,184	-0.0
Remaining markets	67,525	70,263	-3.9
<b>North America</b>	<b>11,638</b>	<b>9,707</b>	<b>+19.9</b>
<b>South America</b>	<b>244,720</b>	<b>219,892</b>	<b>+11.3</b>
of which: Brazil	196,882	173,587	+13.4
<b>Asia-Pacific</b>	<b>30,447</b>	<b>29,922</b>	<b>+1.8</b>
of which: China	4,868	5,518	-11.8
<b>Worldwide</b>	<b>772,705</b>	<b>751,802</b>	<b>+2.8</b>
Volkswagen Commercial Vehicles	551,908	550,156	+0.3
Scania	80,464	67,401	+19.4
MAN	140,333	134,245	+4.5

\* Deliveries for 2012 have been updated and adjusted to reflect subsequent statistical trends and the new reporting structure.

#### DELIVERIES IN THE POWER ENGINEERING SEGMENT

Orders in the Power Engineering segment are usually part of major investment projects. Lead times typically range from just under one year to several years, and partial deliveries as construction progresses are common. Accordingly, there is a time lag between incoming orders and sales revenue from the new construction business.

Sales revenue in the Power Engineering segment was largely driven by Engines & Marine Systems and Turbomachinery, which generated about two-thirds of the overall revenue volume. For example, MAN supplied a powerful 60 MW two-stroke engine for the world's largest container ship in 2013. In addition, a MAN steam turbine is at the heart of the largest solar power plant in the world, which officially went into operation in Abu Dhabi in March 2013.

#### ORDERS RECEIVED IN THE PASSENGER CARS SEGMENT IN WESTERN EUROPE

In fiscal year 2013, overall demand for passenger cars in Western Europe remained below the previous year's level. The Volkswagen Group increased orders received for passenger cars by 6.0% year-on-year, despite the persistently strained economic situation in some Western European markets.

#### ORDERS RECEIVED FOR COMMERCIAL VEHICLES

Demand for the Volkswagen Group's light commercial vehicles in the Western European markets rose slightly year-on-year. Orders were up 1.5% compared with the previous year.

Incoming orders for our trucks and buses developed well overall in fiscal year 2013. In Western Europe, our main sales market, orders received rose in the second half of the year in particular, as purchases were pulled forward because of the introduction of the new Euro 6 emission standard at the start of 2014. Orders received in South America increased due to the high transportation demand and the favorable financing conditions offered by the Brazilian Development Bank. Overall, we received orders for 218,678 (206,445) trucks and buses in the reporting period.

#### ORDERS RECEIVED IN THE POWER ENGINEERING SEGMENT

The long-term performance of the Power Engineering business is determined by the macroeconomic environment. Major individual orders lead to fluctuations in incoming orders during the year that do not correlate with these long-term trends.

Orders received in the Power Engineering segment in the year under review amounted to €3.9 billion. Engines & Marine Systems and Turbomachinery generated the most new orders, together accounting for 69% of the total. Orders were received for liquid gas tanker and cruise ship engines, as well as for compressor technology for a major project in China, among other things.

#### GROUP FINANCIAL SERVICES

Volkswagen Financial Services had a very successful year with its products in the market in fiscal year 2013. 4.3 million new financing, leasing and service/insurance contracts were signed worldwide, a 13.4% increase on the prior-year figure. At 10.7 million, the total number of contracts on December 31, 2013 was up 11.3% on the number as of the end of the previous year. The number of contracts in the Customer Financing/Leasing area was up 9.0% to 6.9 million, while the number of contracts in the Service/Insurance area increased by 15.7% to 3.8 million. Assuming unchanged credit eligibility criteria, the total Group delivery volumes accounted for by financed or leased vehicles increased from 27.5% in the previous year to 28.9%.

In Europe, the number of new contracts signed increased to 2.9 million (2.6 million). The number of contracts was 7.5 million (7.0 million) as of December 31, 2013. The number of financing and leasing contracts was 4.3 million at the end of the reporting period, an increase on the prior-year figure of 4.0 million. The proportion of leased or financed vehicles in this region increased to 45.5% (41.9%).

The Volkswagen Group's financial services business continued to perform well in Germany in fiscal year 2013. At 2.5 million, the number of financing and leasing contracts for new and used vehicles was 3.0% higher than at the end of 2012. The penetration rate rose to 55.8% (53.1%). Volkswagen Financial Services thus finances or leases more than every second vehicle delivered by the Volkswagen Group in Germany.

In North America, 726 thousand new contracts were signed in the reporting period, 9.8% more than in the previous year. The total number of contracts rose by 18.0% to 1.8 million. In the Customer Financing/Leasing area, the number of contracts increased by 11.2% year-on-year to 1.4 million (1.3 million). The proportion of leased or financed vehicles in North America rose to 55.0% (54.4%).

In South America, the total number of contracts was 809 thousand at year-end 2013, 16.0% higher than the prior-year figure. These were almost exclusively attributable to the Customer Financing/Leasing area. Of the vehicles delivered in this region, 33.0% (27.8%) were leased or financed.

In the Asia-Pacific region, Volkswagen Financial Services signed 320 thousand new contracts in 2013, a 41.6% increase on the prior-year figure. The total number of contracts increased by 35.5% to 628 thousand. In the Customer Financing/Leasing area, the number of contracts rose by 39.1% to 517 thousand. Leased or financed vehicles in the Asia-Pacific region accounted for an increased share of 8.3% (6.5%) of deliveries.

#### SALES TO THE DEALER ORGANIZATION

In the reporting period, the Volkswagen Group's worldwide unit sales to the dealer organization – including the Chinese joint ventures – amounted to 9,728,250 vehicles, exceeding the 2012 figure by 4.1%. In particular, the sustained high demand for Group models in China led to a 5.0% year-on-year increase in sales outside Germany. In Germany, 1.7% fewer vehicles were sold. Vehicles sold in Germany decreased to 12.2% (12.9%) of the Group's overall sales.

The Jetta, Golf and Passat were our biggest sellers in 2013. The greatest growth in demand was recorded by the Tiguan, Audi Q3, Audi Q5 and ŠKODA Rapid models, as well as the new Beetle Convertible, Audi A3 Sportback and SEAT Leon models. The Lávda, Sagitar and Santana models available in China were also very popular with customers.

#### PRODUCTION

The Volkswagen Group produced 9,727,848 vehicles worldwide in fiscal year 2013, exceeding the prior-year figure by 5.1%. Our Chinese joint ventures increased their production volume by 18.6% due to the continued strong demand in China. Germany accounted for 25.3% (25.1%) of the Group's total production, remaining on a level with the previous year. In the past year, our plants worldwide produced an average of 39,352 vehicles per working day, an increase of 4.2% year-on-year. The Crafter models built in the Daimler plants in Düsseldorf and Ludwigsfelde and the Routan, which is manufactured in cooperation with Chrysler in North America, are not included in the Volkswagen Group's production figures.

#### INVENTORIES

Global vehicle inventories at Group companies and in the dealer organization were higher on December 31, 2013 than at year-end 2012 due to an increase in inventories in China in response to demand.

#### NUMBER OF EMPLOYEES

Including the Chinese joint ventures, the Volkswagen Group employed an average of 563,066 people in fiscal year 2013, an increase of 5.5% year-on-year. Our companies in Germany employed 255,397 people on average in 2013; their share of the headcount increased slightly to 45.4% (44.4%) due to the creation of new jobs. The Volkswagen Group had 545,596 active employees (+3.9%) as of the 2013 reporting date. In addition, 9,501 employees were in the passive phase of their partial retirement and 17,703 young persons were in vocational traineeships (+5.9%). The Volkswagen Group's headcount was 572,800 employees (+4.2%) at the end of the reporting period. Significant factors in this increase were the volume-related expansion in growth markets, particularly China, and the recruitment of specialists and experts in Germany, among other places. A total of 260,449 people were employed in Germany (+4.4%), while 312,351 were employed abroad (+4.0%).

#### SUMMARY OF BUSINESS DEVELOPMENT

The Board of Management of Volkswagen AG considers business development in the reporting period to have been positive. Despite the persistently challenging environment, we achieved the Group's forecasted delivery volumes, sales revenue and operating profit for 2013 and maintained our market position. We increased the number of deliveries to the Group's customers in the diverse automotive markets by a total of 4.9% to 9.7 million vehicles, a new sales record. The greatest absolute increases were recorded in China and the United Kingdom.

The ratio of capital expenditure to sales revenue in the Automotive Division was higher than in the previous year and was within the expected range. In spite of the higher investments, we

significantly increased net cash flow compared with the previous year and exceeded the minimum required rate of return on invested capital by a clear margin.

Our attractive and environmentally friendly model portfolio impresses customers around the globe. The trust placed in us by customers, as well as our high quality and efficiency standards, allow us to meet and even exceed our financial targets.

The following table shows an overview of the targets set for the reporting period and the figures actually achieved. Detailed information on the financial key performance indicators can be found in the "Results of Operations, Financial Position and Net Assets" chapter starting on page 94.

#### FORECAST VERSUS ACTUAL FIGURES

Core performance indicators in the Volkswagen Group	Forecast for 2013	Actual 2013
Deliveries to customers	> 9.3 million	9.7 million
Sales revenue	> €192.7 billion	€197.0 billion
Operating profit	~ €11.5 billion	€11.7 billion
Operating return on sales	–	5.9%
Capex/sales revenue in the Automotive Division	6-7%	6.3%
Net cash flow in the Automotive Division	positive	€4.4 billion
Return on Investment (ROI) in the Automotive Division	> 9%	14.5%

# *Shares and Bonds*

Volkswagen AG's ordinary and preferred shares again posted gains in fiscal 2013, with preferred shares surpassing the €200.00 barrier for the first time and reaching new highs. The US budget debate and the unresolved European debt crisis generated considerable volatility in some markets. Volkswagen further strengthened its liquidity and capital base through the issue of a mandatory convertible note and hybrid notes.

## EQUITY MARKETS

At the beginning of 2013, the DAX continued the positive performance it had seen in the final quarter of 2012. The increase in share prices was primarily due to the upbeat mood following the provisional budget compromise in the USA. The DAX then moved sideways amid volatility until the end of February. In an environment dominated by the European debt crisis, share prices were supported by largely healthy corporate results. The DAX reached a new high in mid-March. The reasons for this were the central banks' expansionary monetary policy as well as hopes of an increase in global growth. Towards the end of the first quarter, the situation in Cyprus generated renewed uncertainty regarding the stability of the eurozone, initially interrupting the DAX's favorable trend.

It was because of this uncertainty that the DAX's negative trend continued in the opening weeks of the second quarter. At the end of April, worsening economic data then fueled hopes on the financial markets of further interest rate cuts. The ensuing price rise strengthened at the beginning of May, after the European Central Bank had cut its key interest rate to a record low of 0.5% and the USA reported positive economic data. Profit taking, weaker economic data from China and speculation about the end of the expansionary US monetary policy led to falling share prices in the rest of the second quarter. Share prices retreated further in the wake of the US Federal Reserve's announcement of a plan to scale back bond-buying. The markets only showed encouraging trends again at the end of June.

The DAX continued this upward movement until the beginning of August. This was attributable to the positive signals from the American labor market and the central banks' ongoing

expansionary monetary policy, in addition to unexpectedly good economic and corporate data. After moving sideways in the course of August, prices retreated significantly at the end of the month, particularly as a result of the strained political situation in Syria. As early as September, the markets rallied, in part reaching new highs, on the back of expectations that the loose monetary policy would continue. A slight downward trend was seen again up until the end of the third quarter on account of the US budget dispute and other factors.

After a muted start to the final quarter, the DAX continued its upward trend amid low volatility. In addition to the – albeit only temporary – agreement reached in the dispute about raising the debt ceiling in the USA, positive economic data and the interim agreement on the Iranian nuclear program created a buoyant mood in the financial markets. This was also boosted by the European Central Bank again cutting the key interest rate, to 0.25%. Investors' renewed concerns that the expansionary US monetary policy would be curbed led to a correction on the equity markets in the first half of December. However, the brief downward movement was reversed again in mid-December by strong price gains. Although the US Federal Reserve announced it would reduce its bond purchases in stages, it combined this with a commitment to a long-term low interest rate policy. Unexpectedly good economic data in the USA and Europe then pushed Germany's leading index to an all-time high in the last few weeks of trading. At the end of 2013, the DAX had reached 9,552 points, a significant increase on the previous year's figure (+25.5%). The EURO STOXX Automobile & Parts closed the year at 459.5 points, 36.0% higher than at the end of the previous year.

SHARE PRICE DEVELOPMENT FROM DECEMBER 2012 TO DECEMBER 2013

Index based on month-end prices: December 31, 2012 = 100

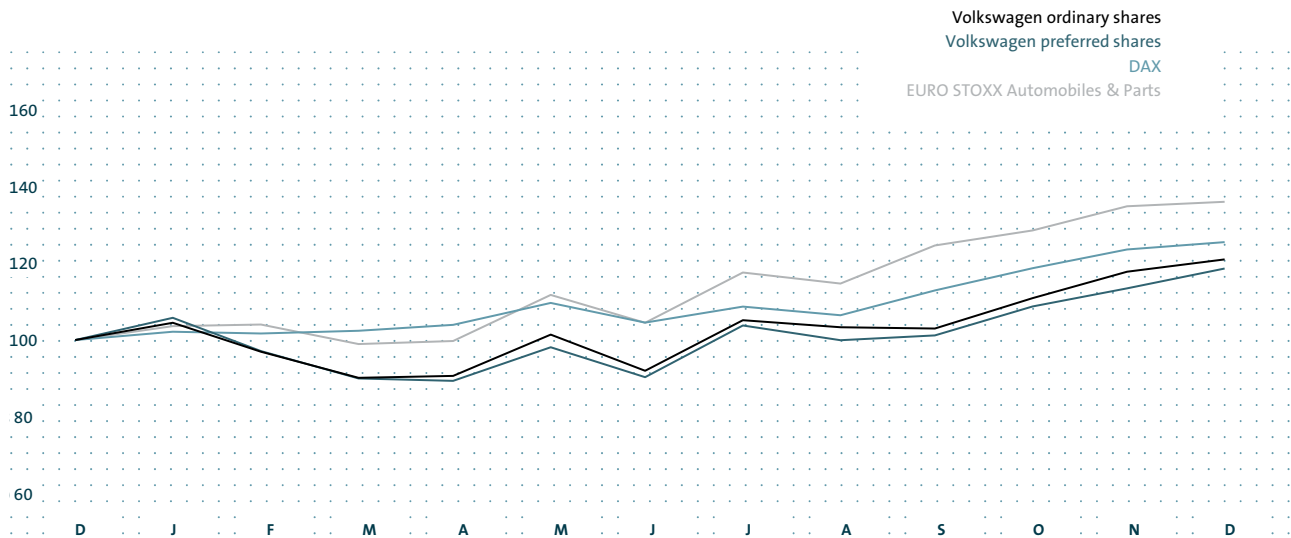

MOVEMENTS IN THE PRICE OF VOLKSWAGEN'S SHARES

On the whole, Volkswagen AG's ordinary and preferred shares performed very positively in 2013, with the Company's preferred shares reaching a new high. However, movements in the share price over the year were marked by considerable volatility. In spite of price gains, the ordinary and preferred shares both underperformed the overall market and the automotive sector.

The year began with a sharp increase in share prices. The announcement that Volkswagen was seeking to enter into a control and profit and loss transfer agreement with MAN SE led prices to drop briefly, however. The securities subsequently moved in parallel to the market before both share classes lost ground once again in March: elements of the outlook for fiscal year 2013 announced when the annual financial statements were published fell short of the high expectations of many market participants.

At the beginning of the second quarter, the prices of Volkswagen AG's preferred and ordinary shares could not escape the negative sentiment in the equity markets and continued their downward trend. From mid-April, Volkswagen share prices then rose with the market as a whole amid greater volatility. The Company's reported sales figures, which exceeded market expectations, were one factor that increased demand for the shares. Similar to the reversal of the trend on the DAX, this upward movement came to a halt at the end of May, however. Over the remainder of the year, the prices for both share classes moved in lock-step with the market as a whole.

In the first few weeks of the third quarter, Volkswagen AG's preferred and ordinary shares initially recorded above-average

growth at a faster pace than the fresh upward movement of the equity markets. This increase was also fueled by corporate data for the first six months of 2013, which exceeded expectations. In line with the decline in the equity markets, prices fell substantially at the end of August. Volkswagen share prices were volatile in the remaining weeks of the third quarter.

This trend reversed in an improved trading environment and the preferred and ordinary shares registered considerable price gains as the fourth quarter progressed. Demand for Volkswagen shares was disproportionately high particularly after the publication of the Group's results for the first three quarters of 2013 at the end of October. The ordinary and preferred shares then followed the overall positive trend of the market as a whole.

Volkswagen AG's preferred shares reached their highest daily closing price for the year, and an all-time high, of €204.15 on December 30, 2013, the last trading day of the year. This was 18.6% higher than at the end of 2012. They recorded their lowest closing price for the year of €138.50 on April 18, 2013.

Volkswagen's ordinary shares also reached their highest closing price of €196.90 on December 30, 2013, 21.0% higher than at the end of 2012. The shares also traded at their lowest daily closing price for the year of €132.60 on April 18, 2013.

Additional Volkswagen share data, plus corporate news, reports and presentations can be downloaded from our website at [www.volkswagenag.com/ir](http://www.volkswagenag.com/ir).

**SHAREHOLDER STRUCTURE AT DECEMBER 31, 2013**  
as a percentage of subscribed capital

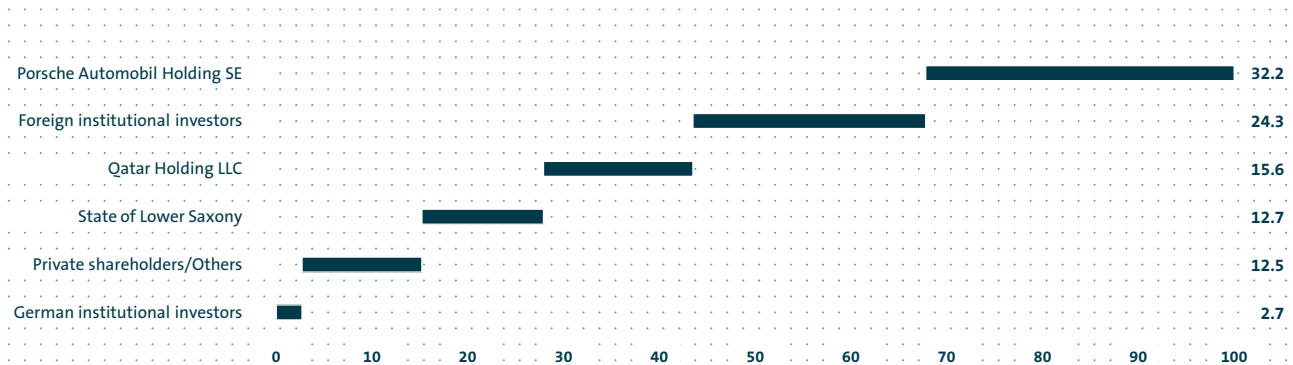

**SHAREHOLDER STRUCTURE AT DECEMBER 31, 2013**

The shareholder structure of Volkswagen AG as of December 31, 2013 is shown in the chart on this page. Volkswagen AG's subscribed capital amounted to €1,191,009,251.84 at the end of the reporting period.

The distribution of voting rights was as follows at the reporting date: Porsche Automobil Holding SE, Stuttgart, held 50.73% of the voting rights. The second-largest shareholder was the State of Lower Saxony, which held 20.0% of the voting rights. Qatar Holding LLC was the third-largest shareholder, with 17.0%. The remaining 12.3% of the 295,089,818 ordinary shares were attributable to other shareholders.

Notifications of changes in voting rights in accordance with the Wertpapierhandelsgesetz (WpHG – German Securities Trading Act) are published on our website at [www.volkswagenag.com/ir](http://www.volkswagenag.com/ir).

**DIVIDEND POLICY**

Our dividend policy matches our financial strategy. In the interests of all stakeholders, we are pursuing continuous dividend growth so that our shareholders can participate appropriately in our business success. The proposed dividend amount therefore reflects our financial management objectives – in particular, ensuring a solid financial foundation as part of the implementation of our Strategy 2018.

The dividend for ordinary and preferred shares proposed by the Board of Management and the Supervisory Board of Volkswagen AG is €0.50 (around 14%) higher than the previous year. On this basis, the total dividend for fiscal year 2013 is €1.9 billion (€1.6 billion). The distribution ratio is based on the Group's profit after tax attributable to the shareholders of Volkswagen AG and is 20.6% for the reporting period. The prior-year figure for fiscal 2012 of 7.5% was affected by noncash income mainly from the updated measurement of the put/call rights relating to the acquisition of the

stake in Porsche AG indirectly held by Porsche SE, as well as the remeasurement of the existing stake in Porsche AG held at the contribution date. After adjusting for these effects, the distribution ratio in 2012 was 17.8%. We are aiming to achieve a distribution ratio of 30% in the medium term.

**DIVIDEND YIELD**

Based on the dividend proposal for the reporting period, the dividend yield on Volkswagen ordinary shares is 2.0%, measured by the closing price on the last trading day in 2013 (2.2%). The dividend yield on preferred shares is 2.0% (2.1%).

The current dividend proposal can be found in the chapter entitled Volkswagen AG (condensed, according to the German Commercial Code), on page 110 of this annual report.

**EARNINGS PER SHARE**

Basic earnings per ordinary share were €18.63 (€46.41) in fiscal year 2013. Basic earnings per preferred share were €18.69 (€46.47). The positive measurement effects from the integration of Porsche should be taken into account in any comparison with the previous year's figures. In accordance with IAS 33, the calculation is based on the weighted average number of ordinary and preferred shares outstanding in the fiscal year.

The calculation of earnings per share for fiscal year 2013 must also make allowance for the effect of the mandatory convertible note with a total volume of €3.7 billion that was issued in November 2012 and supplemented in June 2013. In accordance with IAS 33.23, all potential shares that will be issued upon the conversion of a mandatory convertible note were accounted for as issued shares and included in the calculation of basic and diluted earnings per share. The number of potential preferred shares to be included is based on the most advantageous conversion rate resulting from the minimum conversion price of €150.81. Since the





VOLKSWAGEN SHARE KEY FIGURES

		2013	2012	2011	2010	2009
Dividend development						
Number of no-par value shares at Dec. 31						
Ordinary shares	thousands	295,090	295,090	295,090	295,046	295,005
Preferred shares	thousands	170,148	170,143	170,143	170,143	105,238
Dividend <sup>1</sup>						
per ordinary share	€	4.00	3.50	3.00	2.20	1.60
per preferred share	€	4.06	3.56	3.06	2.26	1.66
Dividend paid <sup>1</sup>						
on ordinary shares	€ million	1,871	1,639	1,406	1,034	754
on preferred shares	€ million	1,180	1,033	885	649	472
	€ million	691	606	521	385	282
Share price development <sup>2</sup>						
Ordinary shares						
Closing	€	196.90	162.75	103.65	105.90	77.00
Price performance	%	+ 21.0	+ 57.0	- 2.1	+ 37.5	- 69.2
Annual high	€	196.90	162.75	136.95	118.50	298.85
Annual low	€	132.60	106.20	84.50	62.30	72.41
Preferred shares						
Closing	€	204.15	172.15	115.75	121.40	65.74
Price performance	%	+ 18.6	+ 48.7	- 4.7	+ 84.7	+ 72.9
Annual high	€	204.15	172.70	151.00	136.90	81.72
Annual low	€	138.50	118.00	88.54	55.83	30.24
Beta factor <sup>3</sup>	factor	1.32	1.26	1.09	0.99	0.87
Market capitalization at Dec. 31	€ billion	92.8	77.3	50.3	51.9	29.6
Equity attributable to Volkswagen AG shareholders and hybrid capital investors at Dec. 31	€ billion	87.7	77.7 <sup>4</sup>	57.5	46.0	35.3
Ratio of market capitalization to equity	factor	1.06	1.00	0.87	1.13	0.84
Key figures per share						
Earnings per ordinary share <sup>5</sup>						
basic	€	18.63	46.41	33.10	15.17	2.37
diluted	€	18.63	46.41	33.10	15.17	2.37
Operating profit <sup>6</sup>	€	24.01	24.59	24.23	15.87	4.64
Cash flows from operating activities <sup>6</sup>	€	25.91	15.42	18.27	25.46	31.84
Equity <sup>7</sup>	€	188.58	166.98	123.68	98.84	88.15
Price/earnings ratio <sup>8</sup>						
Ordinary shares	factor	10.6	3.5	3.1	7.0	32.5
Preferred shares	factor	10.9	3.7	3.5	8.0	26.9
Price/cash flow ratio <sup>9</sup>						
Dividend yield <sup>10</sup>						
Ordinary shares	%	2.0	2.2	2.9	2.1	2.1
Preferred shares	%	2.0	2.1	2.6	1.9	2.5
Stock exchange turnover <sup>11</sup>						
Turnover of Volkswagen ordinary shares						
	€ billion	3.5	3.5	5.1	6.0	23.2
	million shares	21.4	26.8	46.4	79.2	128.1
Turnover of Volkswagen preferred shares						
	€ billion	43.0	40.9	44.2	23.5	8.3
	million shares	252.8	293.3	369.1	305.4	145.0
Volkswagen share of total DAX turnover	%	5.7	5.3	4.6	2.9	3.1

1 Figures for the years 2009 to 2012 relate to dividends paid in the following year. For 2013, the figures relate to the proposed dividend.

2 Xetra prices.

3 See page 107 for the calculation.

4 Prior-year figures adjusted to reflect application of IAS 19R.

5 See note 11 to the consolidated financial statements (Earnings per share) for the calculation. Prior-year figures adjusted in accordance with IAS 33.26.

6 Based on the weighted average number of ordinary and preferred shares outstanding (basic).

7 Based on the total number of ordinary and preferred shares on December 31 (excluding potential shares from the mandatory convertible note).

8 Ratio of year-end-closing price to earnings per share.

9 Using year-end-closing prices of the ordinary shares.

10 Dividend per share based on the year-end-closing price.

11 Order book turnover on the Xetra electronic trading platform (Deutsche Börse).

VOLKSWAGEN SHARE DATA

SECURITIES IDENTIFICATION CODES	PRIMARY MARKET INDICES: ORDINARY SHARES	PRIMARY MARKET INDICES: PREFERRED SHARES	EXCHANGES
<p><b>ORDINARY SHARES</b> ISIN: DE0007664005 WKN: 766400 Deutsche Börse/Bloomberg: VOW Reuters: VOWG.DE</p>	<p>CDAX, Prime All Share, Prime Automobile, MSCI Euro, S&amp;P Global 100 Index</p>	<p>DAX, CDAX, EURO STOXX, EURO STOXX 50, EURO STOXX Automobiles &amp; Parts, Prime All Share, Prime Automobile, Classic All Share, MSCI Euro, CDP Global 500 Climate Performance Leadership Index, CDP Global 500 Climate Disclosure Leadership Index, DJ Sustainability World Index, DJ Sustainability Europe Index, FTSE4Good</p>	<p>Berlin, Düsseldorf, Frankfurt, Hamburg, Hanover, Munich, Stuttgart, Xetra, Luxembourg, New York*, SIX Swiss Exchange</p>
<p><b>PREFERRED SHARES</b> ISIN: DE0007664039 WKN: 766403 Deutsche Börse/Bloomberg: VOW3 Reuters: VOWG_p.DE</p>			

\* Traded in the form of "sponsored unlisted American Depositary Receipts" (ADRs).  
Five ADRs correspond to one underlying Volkswagen ordinary or preferred share.

HIGHLIGHTS IN THE INVESTOR RELATIONS CALENDAR

At the Annual Media and Investor Conference in Wolfsburg on March 14, 2013, the Group's Board of Management looked back on a successful fiscal year in 2012, answered questions from media representatives, analysts and investors, and gave its outlook for the Company and the industry. The day before, on March 13, members of the Board of Management of AUDIAG presented analysts and investors with information on the premium brand's performance and strategy in the Audi Technology Center in Munich.

A Capital Markets Day was held in Mladá Boleslav, Czech Republic, at the beginning of June 2013. The areas of focus were the presentation of the ŠKODA brand and the Volkswagen Group's Eastern European strategy, in which the Czech brand plays a key role. The CEO of ŠKODA and other members of the brand board of management and senior executives provided a comprehensive overview of the company's development and objectives. The director-general of Volkswagen Group Rus explained the strategic focus of the Group in Russia, Eastern Europe's most important market.

The Volkswagen Group received the Corporate Finance Award for fiscal year 2012 from financial journal "Börsen-Zeitung" on June 28, 2013. The award recognizes outstanding transactions

from a corporate strategy and financing perspective. The jury cited the successful creation of the integrated automotive group with Porsche, the expansion of the commercial vehicles business by acquiring a majority stake in MAN SE and the successful issue of a mandatory convertible note as the reasons for its choice.

On September 9, 2013, one day before the opening of the Frankfurt Motor Show, members of the Group Board of Management and members of the brand boards of management provided in-depth briefings to our analysts and investors on the status of the implementation of our Strategy 2018 at another Capital Markets Day. The chief development officer of the Volkswagen Passenger Cars brand gave a talk on sustainable mobility and efficient drive technologies, which was followed by a presentation by the CEO of Volkswagen Financial Services AG on the growing importance of attractive financial services at the global level. The Board of Management member with responsibility for China spoke at length about what is now the Group's largest sales market. The closing speech was given by the Chief Financial Officer of the Volkswagen Group, who outlined the Group's brand and product strategy as well as its results of operations. In the evening, our guests at the Volkswagen Group Night were given an overview of new features of the Group brands, with electric and hybrid vehicles in the spotlight.

**REFINANCING STRUCTURE OF THE VOLKSWAGEN GROUP**  
as of December 31, 2013

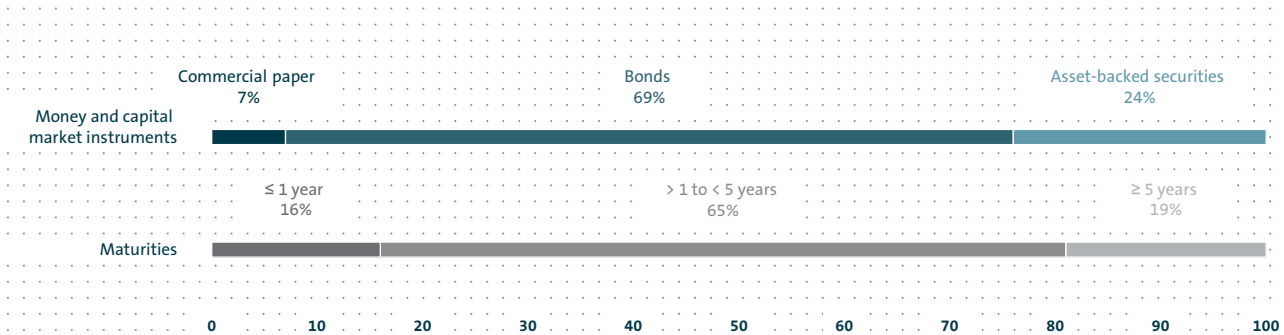

**REFINANCING**

The Volkswagen Group's refinancing activities in 2013 continued to focus on the diversification of its issues, in particular using instruments with an equity component and longer maturities. We intend to further diversify our refinancing instruments in the future as well.

In this connection, for the first time, we issued unsecured subordinated hybrid notes with a principal amount of €2.0 billion. The perpetual hybrid notes were issued in two tranches and can only be called by the issuer. The first call date for the first tranche with a volume of €1.25 billion is after five years, and the first call date for the second tranche of €0.75 billion is after ten years.

In addition, the €2.5 billion mandatory convertible note that was successfully issued in November 2012 entitling and obliging the holders to subscribe for Volkswagen preferred shares was supplemented in June 2013 by another €1.2 billion mandatory convertible note.

To access new groups of investors, Volkswagen also placed an increasing number of fixed-rate bonds with a range of maturities of more than five years in the market. Here, we additionally offered maturities of more than 20 years for the first time. The maturity structure of the bonds we issued is shown in the chart above.

Although our activities are still concentrated geographically on the European refinancing market, we have also placed issues

outside of Europe. Specifically, Volkswagen was active in the US capital market with a USD 2.15 billion issue.

In the asset-backed securities segment, the Volkswagen Group issued securities with a total value of €10.7 billion that are focused on Europe and North America.

We generally eliminate interest rate and foreign currency risk in all our financing transactions by entering into derivatives contracts at the same time.

The table below shows how our money and capital market programs were utilized as of December 31, 2013 and illustrates the financial flexibility of the Volkswagen Group:

Program	Authorized volume € billion	Amount utilized on Dec. 31, 2013 € billion
Commercial paper	25.2	5.4
Bonds	97.9	53.8
of which USD issues in the USA		8.1
of which hybrid issues		2.0
Asset-backed securities	49.3	19.1

RATINGS

	VOLKSWAGEN AG			VOLKSWAGEN FINANCIAL SERVICES AG			VOLKSWAGEN BANK GMBH		
	2013	2012	2011	2013	2012	2011	2013	2012	2011
<b>Standard &amp; Poor's</b>									
Short-term	A-2	A-2	A-2	A-2	A-2	A-2	A-2	A-2	A-2
Long-term	A-	A-	A-	A-	A-	A-	A-	A-	A-
Outlook	positive	positive	stable	positive	positive	stable	positive	positive	stable
<b>Moody's Investors Service</b>									
Short-term	P-2	P-2	P-2	P-2	P-2	P-2	P-2	P-2	P-2
Long-term	A3	A3	A3	A3	A3	A3	A3	A3	A3
Outlook	positive	positive	positive	positive	positive	positive	positive	positive	positive

The syndicated credit line of €5.0 billion agreed in July 2011 including two options for extension by a year in each case was extended for the second time by one year to July 2018 (from July 2016 to July 2018 with a reduced amount of €4.916 billion). The credit line remains unused.

Syndicated credit lines worth a total of €3.2 billion at other Group companies have also not been drawn down. In addition, Group companies arranged bilateral credit lines with national and international banks in various other countries for a total of €9.3 billion, of which €2.1 billion has not been drawn down.

These extensive financing measures ensure the solvency of the Volkswagen Group at all times.

RATINGS

In 2013, rating agencies Standard & Poor's and Moody's Investors Service undertook their regular update of their credit ratings for Volkswagen AG, Volkswagen Financial Services AG and Volkswagen Bank GmbH. Standard & Poor's confirmed its short-term and long-term ratings of A-2 and A- respectively for Volkswagen AG, Volkswagen Financial Services AG and Volkswagen Bank GmbH. The outlook for all three companies remains "positive".

Moody's Investors Service confirmed its short-term and long-term ratings for Volkswagen AG, Volkswagen Financial Services AG and Volkswagen Bank GmbH at P-2 and A3 respectively and also left the outlook for all three companies unchanged at "positive".

oekom research AG, which issues ratings for companies in the sustainable investment segment, rates Volkswagen at B- on a twelve-point scale ranging from A+ to D-. Volkswagen thus enjoys "prime status" as one of the leading companies in its industry. oekom research rates a company's social and environmental performance in connection with the corporate ratings performed on the basis of over 100 criteria selected for specific industries.

OUR INVESTOR RELATIONS TEAM IS AVAILABLE FOR QUERIES AND COMMENTS AT ALL TIMES:

WOLFSBURG OFFICE (VOLKSWAGEN AG)

Phone + 49 (0)5361 9-86622 IR hotline  
Fax + 49 (0)5361 9-30411  
E-mail investor.relations@volkswagen.de  
Internet www.volkswagenag.com/ir

LONDON OFFICE

Phone + 44 20 3693 6060

BEIJING OFFICE

Phone + 86 10 6531 3000

INVESTOR RELATIONS LIAISON OFFICE (VOLKSWAGEN GROUP OF AMERICA, INC.)

(Questions relating to American Depositary Receipts)  
Phone + 1 703 364 7000

**RESULTS OF THE RobecoSAM 2013 ASSESSMENT**  
in percent

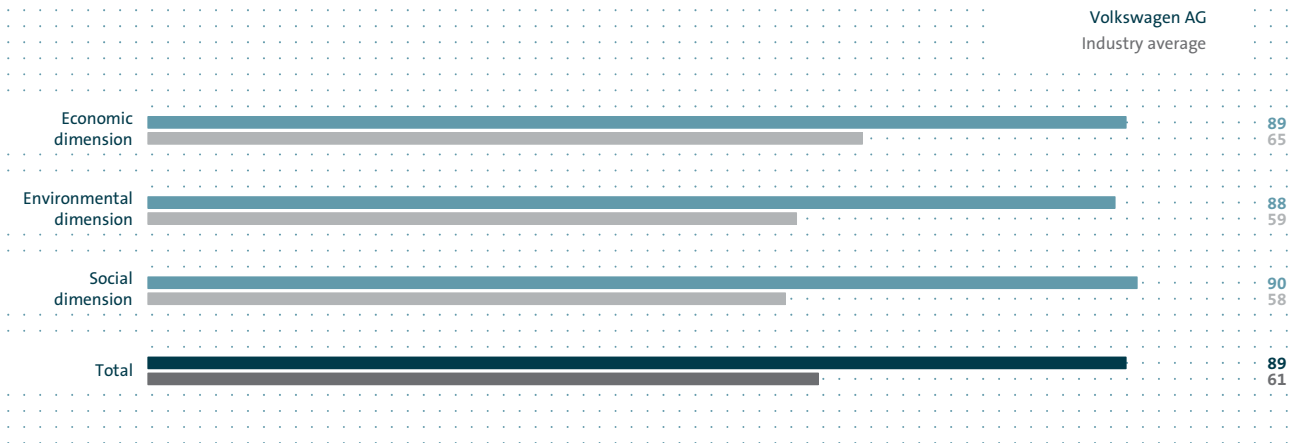

**VOLKSWAGEN IN SUSTAINABILITY RANKINGS AND INDICES**

As analysts and investors view corporate social responsibility (CSR) and sustainability performance as leading indicators of forward-looking corporate leadership, they also increasingly base their recommendations and decisions on companies' CSR and sustainability profile. Sustainability ratings are particularly well suited to evaluating a company's environmental, social and economic performance. If a company achieves the highest scores in these ratings, it not only sends a clear signal to its stakeholders, but also raises its attractiveness as an employer and the motivation of its existing employees.

In 2013, Volkswagen ranked higher than in the previous year in the most important international rankings and corresponding indices, obtaining a leading position in its sector. The Group was listed as the most sustainable automobile manufacturer in RobecoSAM AG's leading global sustainability rating. The Company was thus classified as an industry group leader for the automotive industry in the Dow Jones Sustainability indices. RobecoSAM AG examines performance in the field of economic, environmental and social sustainability. Volkswagen was named the best in its industry

in the categories of innovation management, climate strategy and corporate citizenship, among others. As in the previous year, MAN is the only German company from the industrial engineering sector to be represented in the Dow Jones Sustainability World and the Dow Jones Sustainability Europe indices, and succeeded in lifting its rating even higher compared with the previous year.

The Volkswagen Group also improved its position in the Carbon Disclosure Project (CDP). The Volkswagen Group was included for the first time in both the CDP Global 500 Climate Performance Leadership Index and the CDP Global 500 Climate Disclosure Leadership Index.

In addition to the indices shown in the table on page 90, Volkswagen was represented in the following sustainability indices as of December 31, 2013: ECPI Ethical Index Europe, ECPI Ethical Index EMU, ECPI Ethical Index Global, Ethibel Sustainability Index Excellence Global, Ethibel Sustainability Index Excellence Europe, Euronext-Vigeo Eurozone 120 Index, Global Compact 100 and STOXX Global ESG Environmental Leaders Index, STOXX Global ESG Social Leaders Index, STOXX Global ESG Governance Leaders Index.

**FURTHER INFORMATION ON SUSTAINABILITY**  
[www.volkswagenag.com/sustainability](http://www.volkswagenag.com/sustainability)

# Results of Operations, Financial Position and Net Assets

The Volkswagen Group continued its successful course despite the difficult market environment, with sales revenue and operating profit again up on the record prior-year level in fiscal year 2013.

The Volkswagen Group's segment reporting in compliance with IFRS 8 comprises the four reportable segments Passenger Cars, Commercial Vehicles, Power Engineering and Financial Services, in line with the Group's internal reporting and management.

At Volkswagen, segment profit or loss is measured on the basis of operating profit or loss.

The reconciliation contains activities and other operations that do not by definition constitute segments. These include the unallocated Group financing activities. Consolidation adjustments between the segments (including the holding company functions) are also contained in the reconciliation. Purchase price allocation for Porsche Holding Salzburg and Porsche, as well as for Scania and MAN, is in line with their accounting treatment in the segments.

The Automotive Division comprises the Passenger Cars, Commercial Vehicles and Power Engineering segments, as well as the figures from the reconciliation. The Passenger Cars segment and the reconciliation are combined to form the Passenger Cars Business Area. We report on the Commercial Vehicles and Power Engineering segments under the Commercial Vehicles/Power

Engineering Business Area. The Financial Services Division corresponds to the Financial Services segment.

Activities in the Passenger Cars segment cover the development of vehicles and engines, the production and sale of passenger cars, and the genuine parts business. This segment combines the Volkswagen Group's individual passenger car brands on a consolidated basis. It also includes the Ducati brand's motorcycle business.

The Commercial Vehicles segment primarily comprises the development, production and sale of light commercial vehicles, trucks and buses from the Volkswagen Commercial Vehicles, Scania and MAN brands, the corresponding genuine parts business and related services.

The Power Engineering segment combines the large-bore diesel engines, turbomachinery, special gear units, propulsion components and testing systems businesses.

The activities of the Financial Services segment comprise dealer and customer financing, leasing, banking and insurance activities, fleet management and mobility offerings.

## KEY FIGURES FOR 2013 BY SEGMENT

€ million	Passenger Cars	Commercial Vehicles	Power Engineering	Financial Services	Total segments	Reconciliation	Volkswagen Group
Sales revenue	157,048	31,076	3,851	22,004	213,979	-16,972	197,007
Segment profit or loss (operating profit or loss)	11,053	1,044	-250	1,863	13,711	-2,040	11,671
as a percentage of sales revenue	7.0	3.4	-6.5	8.5			5.9
Acquisition of property, plant and equipment, and capitalized development costs	13,544	1,329	137	345	15,355	52	15,407

#### CHANGES TO THE REPORTING STRUCTURE AND AMENDMENTS TO IAS 19

Since January 1, 2013, we have combined the light commercial vehicles, trucks and buses, and power engineering businesses into a new Commercial Vehicles/Power Engineering Business Area.

IAS 19R changes the way employee benefits are accounted for. For the Volkswagen Group, this led to adjustments to bonus payments relating to partial retirement agreements in particular.

The corresponding prior-year figures in the income statement, the cash flow statement and the balance sheet have been adjusted.

#### CONTROL AND PROFIT AND LOSS TRANSFER AGREEMENT WITH MAN SE

Following its approval by the Annual General Meeting of MAN SE on June 6, 2013 and its entry in the commercial register on July 16, 2013, the control and profit and loss transfer agreement in accordance with section 291 of the Aktiengesetz (AktG – German Stock Corporation Act) between MAN SE, as the controlled company, and Truck & Bus GmbH, a wholly owned subsidiary of Volkswagen AG, as the controlling company, entered into force. The obligation to transfer profits is effective as of the fiscal year beginning on January 1, 2014; the obligation to absorb losses is effective for the first time as of fiscal year 2013. As a consequence of the approval by the Annual General Meeting of MAN SE of the control and profit and loss transfer agreement, a liability in the total amount of €3.1 billion

(€80.89 per share) was recognized in the balance sheet for the obligation to acquire the shares held by the remaining free float shareholders of MAN; equity was reduced accordingly.

In July 2013, Truck & Bus GmbH was served with an application in accordance with section 1 no. 1 of the Spruchverfahrensgesetz (SpruchG – German Award Proceedings Act) for judicial review of the appropriateness of the cash settlement in accordance with section 305 of the Aktiengesetz (AktG – German Stock Corporation Act) and the cash compensation in accordance with section 304 of the AktG for the noncontrolling interest shareholders of MAN SE attributable to the control and profit and loss transfer agreement between MAN SE and Truck & Bus GmbH, which was entered in MAN SE's commercial register on July 16, 2013. The expected present value of the minimum statutory interest rate was also recognized as a liability in the amount of €0.5 billion as a result of the opening of the award proceedings in connection with the control and profit and loss transfer agreement.

#### RESULTS OF OPERATIONS

##### Results of operations of the Group

The Volkswagen Group generated sales revenue of €197.0 billion in 2013, 2.2% higher than in 2012. Although the slight decline in volumes – excluding the Chinese joint ventures – and in particular negative exchange rate effects depressed sales revenue year-on-year,

#### INCOME STATEMENT BY DIVISION

€ million	VOLKSWAGEN GROUP		AUTOMOTIVE <sup>1</sup>		FINANCIAL SERVICES	
	2013	2012 <sup>2</sup>	2013	2012 <sup>2</sup>	2013	2012 <sup>2</sup>
<b>Sales revenue</b>	<b>197,007</b>	<b>192,676</b>	<b>175,003</b>	<b>172,822</b>	<b>22,004</b>	<b>19,854</b>
Cost of sales	-161,407	-157,522	-144,481	-142,159	-16,926	-15,364
<b>Gross profit</b>	<b>35,600</b>	<b>35,154</b>	<b>30,522</b>	<b>30,664</b>	<b>5,078</b>	<b>4,490</b>
Distribution expenses	-19,655	-18,850	-18,604	-17,932	-1,050	-918
Administrative expenses	-6,888	-6,220	-5,682	-5,154	-1,206	-1,066
Net other operating income	2,613	1,415	3,571	2,336	-958	-921
<b>Operating profit</b>	<b>11,671</b>	<b>11,498</b>	<b>9,807</b>	<b>9,913</b>	<b>1,863</b>	<b>1,585</b>
Share of profits and losses of equity-accounted investments	3,588	13,568	3,513	13,423	76	145
Other financial result	-2,831	421	-2,858	561	27	-140
<b>Financial result</b>	<b>757</b>	<b>13,989</b>	<b>655</b>	<b>13,984</b>	<b>102</b>	<b>5</b>
<b>Profit before tax</b>	<b>12,428</b>	<b>25,487</b>	<b>10,462</b>	<b>23,897</b>	<b>1,966</b>	<b>1,590</b>
Income tax expense	-3,283	-3,606	-2,873	-3,218	-410	-388
<b>Profit after tax</b>	<b>9,145</b>	<b>21,881</b>	<b>7,590</b>	<b>20,678</b>	<b>1,555</b>	<b>1,202</b>
Noncontrolling interests	52	169	-9	146	61	23
Profit attributable to Volkswagen AG hybrid capital investors	27	-	27	-	-	-
<b>Profit attributable to Volkswagen AG shareholders</b>	<b>9,066</b>	<b>21,712</b>	<b>7,572</b>	<b>20,532</b>	<b>1,494</b>	<b>1,180</b>

1 Including allocation of consolidation adjustments between the Automotive and Financial Services divisions.

2 Prior-year figures adjusted to reflect application of IAS 19R.

**SEGMENT REPORTING – SHARE OF SALES REVENUE BY MARKET 2013**

*in percent*

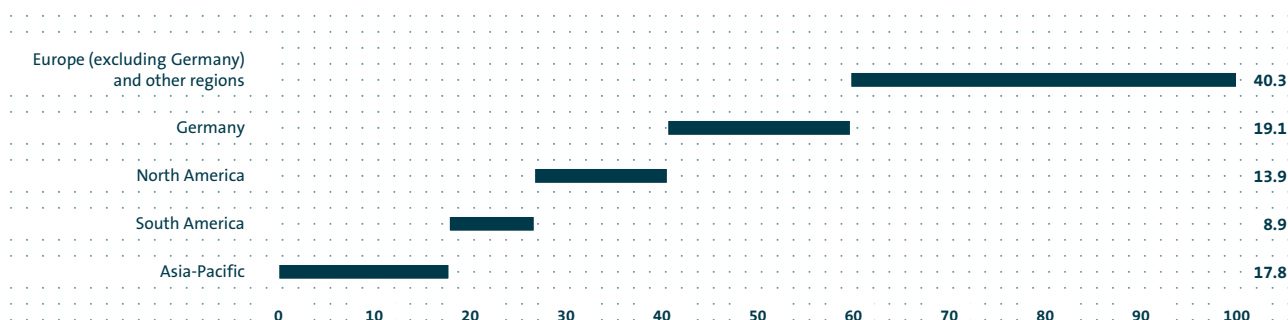

these effects were more than offset by the initial full-year consolidation of Porsche and the good business performance by the Financial Services Division. The largest proportion of sales revenue, at 80.9% (80.4%), was recorded outside of Germany.

Gross profit was slightly up on the previous year, at €35.6 billion (€35.2 billion). Depreciation charges resulting from increased capital expenditures, higher research and development costs, negative mix effects as well as contingency reserves had a negative impact. The gross margin was virtually unchanged at 18.1% (18.2%).

The Volkswagen Group generated an operating profit of €11.7 billion in the fiscal year 2013, surpassing the record prior-year figure (€11.5 billion). Distribution and administrative expenses increased as a result of the initial full-year consolidation of Porsche. At €2.6 billion, other operating income exceeded the prior-year figure, mainly as a result of lower expenses related to exchange rate factors. The operating return on sales was 5.9% (6.0%).

At €12.4 billion, the Volkswagen Group's profit before tax in 2013 was down on the prior-year period, when measurement effects in connection with the integration of Porsche (€12.3 billion) had a clearly positive impact on the financial result. The return on sales before tax declined from 13.2% to 6.3%. Profit after tax consequently declined by €12.7 billion to €9.1 billion. The tax rate rose to 26.4% (14.1%); the effects from the updated measurement of options relating to Porsche and the remeasurement of the existing shares held did not affect tax expense in the previous year.

**Results of operations in the Automotive Division**

The Automotive Division's sales revenue rose slightly year-on-year to €175.0 billion (€172.8 billion). Declining volumes and negative exchange rate effects were more than offset mainly by the initial full-year consolidation of Porsche. As our Chinese joint ventures are accounted for using the equity method, the Group's positive business growth in the Chinese passenger car market is mainly reflected in the Group's sales revenue only by deliveries of vehicles and vehicle parts.

Gross profit in the Automotive Division was down slightly on the previous year at €30.5 billion (€30.7 billion). Negative effects from lower sales volumes, mix, deteriorations in exchange rates and higher depreciation charges as a result of increased capital expenditures, as well as higher research and development costs, particularly for new drive concepts, were not offset by positive effects from the consolidation of Porsche and improved product costs. Contingency reserves running into the hundreds of millions of euros in each case were also recognized in profit or loss in the areas of passenger cars and power engineering. Write-downs relating to purchase price allocations also had a negative impact, but to a lesser extent than in the previous year, as expected.

Distribution and administrative expenses increased by 3.7% and 10.2% year-on-year respectively. The ratio of both distribution and administrative expenses to sales revenue also increased. This increase was mainly attributable to the initial full-year inclusion of the companies consolidated in the previous year. Currency-related factors saw other operating income improve to €3.6 billion (€2.3 billion).

The Automotive Division generated an operating profit of €9.8 billion (€9.9 billion) in 2013. At 5.6%, the operating return on sales was on a level with the previous year (5.7%). The extremely positive business growth of our Chinese joint ventures is mainly reflected in the Group's operating profit only by deliveries of vehicles and vehicle parts. The profit recorded by the joint venture companies is accounted for in the financial result using the equity method.

The financial result declined to €0.7 billion (€14.0 billion) in the reporting period. In the previous year, the financial result had been positively affected especially by the updating of the underlying assumptions used in the valuation models for measuring the put/call rights relating to Porsche Holding Stuttgart GmbH and the remeasurement at the contribution date of the shares in Porsche AG already held indirectly (€12.3 billion).



Following the opening of the award proceedings in connection with the control and profit and loss transfer agreement with MAN SE in July 2013, the expected present value of the minimum statutory interest rate was recognized in the other financial result (€0.5 billion). Derivative financial instruments had a negative effect. Income from the equity-accounted Chinese joint ventures included in the consolidated financial statements was up on the high prior-year figure.

#### RESULTS OF OPERATIONS IN THE PASSENGER CARS BUSINESS AREA

€ million	2013	2012*
Sales revenue	140,077	138,571
Gross profit	25,872	25,886
Operating profit	9,013	8,968

\* Prior-year figures adjusted to reflect application of IAS 19R.

The Passenger Cars Business Area generated sales revenue of €140.1 billion in 2013, which was up slightly on the previous year (€138.6 billion). At €25.9 billion, gross profit was on a level with the high prior-year figure (€25.9 billion). The decline in volumes (excluding the Chinese joint ventures), deteriorations in exchange rates and mix, higher depreciation charges as a result of increased capital expenditures, higher research and development costs, and the recognition of contingency reserves were negative factors. The initial full-year consolidation of Porsche in 2013, optimized product costs and lower write-downs relating to purchase price allocations had a positive effect. Operating profit in the Passenger Cars Business Area amounted to €9.0 billion, as in the previous year. The operating return on sales was 6.4% (6.5%).

#### RESULTS OF OPERATIONS IN THE COMMERCIAL VEHICLES/ POWER ENGINEERING BUSINESS AREA

€ million	2013	2012*
Sales revenue	34,927	34,251
Gross profit	4,650	4,777
Operating profit	794	945

\* Prior-year figures adjusted to reflect application of IAS 19R.

The Commercial Vehicles/Power Engineering Business Area generated sales revenue of €34.9 billion in fiscal 2013 (€34.3 billion), of which €3.9 billion (€4.2 billion) was attributable to the Power Engineering segment. At €4.7 billion, gross profit was

down slightly on the previous year (€4.8 billion). Operating profit declined to €0.8 billion (€0.9 billion), while the operating return on sales decreased from 2.8% to 2.3%. In addition to the write-downs relating to purchase price allocation for MAN and Scania, this was negatively impacted by increased competitive pressure on prices and margins. At €-250 million (€162 million), operating profit in the Power Engineering segment was well below the prior-year figure, and was negatively impacted by project-specific contingency reserves and declines in the license and after sales businesses.

#### Results of operations in the Financial Services Division

Sales revenue in the Financial Services Division amounted to €22.0 billion in fiscal year 2013, 10.8% higher than in the previous year due to growth in business volumes and the initial full-year consolidation of Porsche's financial services business.

Gross profit improved by 13.1% to €5.1 billion. Distribution and administrative expenses increased year-on-year in the reporting period, while the ratio of both distribution and administrative expenses to sales revenue rose slightly. Alongside higher volumes and the consolidation of Porsche, this was attributable to additional expenses to comply with stricter banking supervision requirements. Other operating income amounted to €-1.0 billion (€-0.9 billion). The Financial Services Division once again made a significant contribution to the Group's earnings with an operating profit of €1.9 billion, up 17.6% on the previous year. The operating return on sales increased to 8.5% (8.0%), and return on equity before tax rose year-on-year to 14.3% (13.1%).

#### PRINCIPLES AND GOALS OF FINANCIAL MANAGEMENT

Financial management at the Volkswagen Group covers liquidity management, currency, interest rate and commodity risk management, as well as credit and country risk management. It is performed centrally for all Group companies by Group Treasury, based on internal directives and risk parameters. The Scania subgroup is not coordinated centrally due to legal restrictions related to stock exchange law. The integration process for MAN has not yet been fully completed.

With regard to liquidity, the goals of financial management are to ensure that the Volkswagen Group remains solvent at all times and to achieve an adequate return from the investment of surplus funds. The Group's material companies in Europe also use cash pooling to optimize the use of existing liquidity. This enables Group companies to pool the balances accumulating on cash pooling accounts on a daily basis by closing out these accounts and transferring both the positive and negative balances to a target account at Group Treasury. Currency, interest rate and commodity risk management is designed to hedge the prices on which investment, production and sales plans are based using derivative financial instruments. Credit and country risk management aims to use diversification to avoid exposing the Volkswagen Group to the risk of loss or default. To achieve this, internal limits are defined for the volume of business per counterparty when entering into

financial transactions. Various rating criteria are taken into account when setting these limits, including the ratings awarded by independent agencies and the capital resources of potential counterparties. The relevant risk limits and the authorized financial instruments, hedging methods and hedging horizons are approved by the Executive Committee for Liquidity and Foreign Currency.

For additional information on the principles and goals of financial management, please refer to page 162 and to the notes to the 2013 consolidated financial statements on pages 254 to 262.

## FINANCIAL POSITION

### Financial position and cash and cash equivalents in the Group

The Volkswagen Group's gross cash flow was €24.4 billion in fiscal year 2013, up 21.5% on the prior-year figure. Funds tied up in working capital amounted to €11.8 billion, €1.1 billion lower than in the previous year. Cash flows from operating activities consequently rose by €5.4 billion to €12.6 billion.

At €14.9 billion, the Volkswagen Group's investing activities attributable to operating activities in fiscal year 2013 were down 11.3% on the previous year, which had been characterized by the contribution in full of Porsche and the acquisition of Ducati. Investments in property, plant and equipment rose year-on-year to €11.4 billion (€10.5 billion). Net cash flow improved by €7.3 billion to €-2.3 billion.

Cash inflows from financing activities amounted to €9.0 billion (€13.7 billion). This figure includes the mandatory convertible note issued in June and the hybrid notes placed in August, which increased net liquidity by €1.1 billion and €2.0 billion, respectively. In the previous year, the increase in the stake in MAN SE led to a cash outflow of approximately €2.1 billion, while the mandatory convertible note issued in November 2012 increased net liquidity by €2.0 billion.

Cash and cash equivalents in the Volkswagen Group as reported in the cash flow statement amounted to €22.0 billion as of the end of the fiscal year, up €4.2 billion on the prior-year figure. Gross liquidity rose by €7.0 billion to €39.2 billion. Net liquidity in the Group was €-82.3 billion, compared with €-85.5 billion as of December 31, 2012.

### Financial position in the Automotive Division

The Automotive Division's gross cash flow amounted to €18.7 billion (€15.8 billion) in fiscal year 2013. The year-on-year increase was due to earnings-related factors and lower tax

payments, following tax payments for previous years made in 2012. Strict working capital management led to the release of €1.9 billion (€0.5 billion). As a result, cash flows from operating activities increased by €4.4 billion to €20.6 billion.

At €16.2 billion, the cash outflow from investing activities attributable to operating activities in the reporting period was €0.3 billion lower than in the previous year. Investments in property, plant and equipment amounted to €11.0 billion (€10.3 billion), producing a ratio of investments in property, plant and equipment (capex) to sales revenue of 6.3% (5.9%). We invested mainly in our production facilities and in models that we launched in 2013 or are planning to launch in 2014. These are primarily vehicles in the up!, Golf, Passat, Audi A3, Audi TT and ŠKODA Fabia series, as well as the Porsche Macan and the Porsche Panamera. Other investment focuses were the ecological focus of our model range, the growing use of electric drives and our modular toolkits. Capitalized development costs rose to €4.0 billion (€2.6 billion). Volkswagen Bank GmbH sold its 50% indirect interest in LeasePlan Corporation N.V. to Volkswagen AG for approximately €1.7 billion as part of internal restructuring measures designed to strengthen equity in the Financial Services Division. This reduced liquidity within investing activities attributable to the Automotive Division. In the previous year, cash flows from investing activities were impacted by the integration in full of Porsche and the acquisition of Ducati. The Automotive Division's net cash flow rose significantly by €4.6 billion to €4.4 billion.

In June 2013, we successfully placed a mandatory convertible note with an aggregate principal amount of €1.2 billion – €1.1 billion of which was classified as a capital contribution and increased net liquidity – via Volkswagen International Finance N.V. Like the mandatory convertible note issued in November 2012, which it supplements, this has a coupon of 5.50% and matures on November 9, 2015, though the note terms and conditions provide for early conversion options.

In August 2013, the Volkswagen Group successfully placed dual-tranche hybrid notes with an aggregate principal amount of €2.0 billion via Volkswagen International Finance N.V. They consist of a €1.25 billion note that carries a coupon of 3.875% and has a first call date after five years, and a €0.75 billion note that carries a coupon of 5.125% and has a first call date after ten years. Both tranches are perpetual and increase equity by the full amount, net of transaction costs. €2.0 billion of the hybrid notes was classified as a capital contribution, which increased net liquidity.

The dividend paid out to the shareholders of Volkswagen AG rose by €0.2 billion to €1.6 billion.

**GROUP MANAGEMENT REPORT**  
Results of Operations, Financial Position and Net Assets

**CASH FLOW STATEMENT BY DIVISION**

€ million	VOLKSWAGEN GROUP		AUTOMOTIVE <sup>1</sup>		FINANCIAL SERVICES	
	2013	2012 <sup>2</sup>	2013	2012 <sup>2</sup>	2013	2012 <sup>2</sup>
<b>Cash and cash equivalents at beginning of period</b>	<b>17,794</b>	<b>16,495</b>	<b>14,788</b>	<b>12,668</b>	<b>3,005</b>	<b>3,827</b>
Profit before tax	12,428	25,487	10,462	23,897	1,966	1,590
Income taxes paid	-3,107	-5,056	-2,622	-4,514	-486	-542
Depreciation and amortization expense	14,686	13,135	10,786	9,982	3,900	3,152
Change in pension provisions	179	95	168	87	11	7
Other noncash income/expense and reclassifications <sup>3</sup>	218	-13,575	-107	-13,678	325	103
<b>Gross cash flow</b>	<b>24,404</b>	<b>20,085</b>	<b>18,688</b>	<b>15,774</b>	<b>5,716</b>	<b>4,311</b>
<b>Change in working capital</b>	<b>-11,809</b>	<b>-12,876</b>	<b>1,925</b>	<b>458</b>	<b>-13,733</b>	<b>-13,334</b>
Change in inventories	-1,021	460	-729	1,044	-292	-584
Change in receivables	-1,651	-56	-1,163	114	-489	-171
Change in liabilities	2,363	-236	2,118	-627	245	391
Change in other provisions	2,300	375	2,241	61	59	314
Change in leasing and rental assets (excluding depreciation)	-7,112	-5,606	-465	-232	-6,647	-5,374
Change in financial services receivables	-6,688	-7,814	-77	96	-6,611	-7,910
<b>Cash flows from operating activities</b>	<b>12,595</b>	<b>7,209</b>	<b>20,612<sup>4</sup></b>	<b>16,232<sup>4</sup></b>	<b>-8,017</b>	<b>-9,023</b>
<b>Cash flows from investing activities attributable to operating activities</b>	<b>-14,936</b>	<b>-16,840</b>	<b>-16,199</b>	<b>-16,455</b>	<b>1,263</b>	<b>-385</b>
of which: acquisition of property, plant and equipment	-11,385	-10,493	-11,040	-10,271	-345	-222
capitalized development costs	-4,021	-2,615	-4,021	-2,615	-	-
acquisition and disposal of equity investments	-151	-4,105	-1,702	-3,927	1,551	-179
<b>Net cash flow<sup>5</sup></b>	<b>-2,341</b>	<b>-9,631</b>	<b>4,413</b>	<b>-223</b>	<b>-6,754</b>	<b>-9,408</b>
Change in investments in securities and loans	-1,954	-2,643	-1,298	-111	-656	-2,532
<b>Cash flows from investing activities</b>	<b>-16,890</b>	<b>-19,482</b>	<b>-17,497</b>	<b>-16,565</b>	<b>607</b>	<b>-2,917</b>
<b>Cash flows from financing activities</b>	<b>8,973</b>	<b>13,712</b>	<b>1,734</b>	<b>2,551</b>	<b>7,239</b>	<b>11,161</b>
of which: capital transactions with noncontrolling interests	0	-2,101	0	-2,101	-	-
Capital contributions/capital redemptions	3,067	2,046	3,015	1,351	52	696
Effect to exchange rate changes on cash and cash equivalents	-462	-141	-353	-98	-110	-43
<b>Net change in cash and cash equivalents</b>	<b>4,216</b>	<b>1,298</b>	<b>4,497</b>	<b>2,120</b>	<b>-281</b>	<b>-822</b>
<b>Cash and cash equivalents at Dec. 31<sup>6</sup></b>	<b>22,009</b>	<b>17,794</b>	<b>19,285</b>	<b>14,788</b>	<b>2,724</b>	<b>3,005</b>
Securities, loans and time deposits	17,177	14,352	9,515	8,110	7,661	6,242
<b>Gross liquidity</b>	<b>39,186</b>	<b>32,146</b>	<b>28,800</b>	<b>22,898</b>	<b>10,386</b>	<b>9,248</b>
Total third-party borrowings	-121,504	-117,663	-11,932	-12,324	-109,572	-105,338
<b>Net liquidity</b>	<b>-82,318</b>	<b>-85,517</b>	<b>16,869</b>	<b>10,573</b>	<b>-99,186</b>	<b>-96,090</b>

1 Including allocation of consolidation adjustments between the Automotive and Financial Services divisions.

2 Prior-year figures adjusted to reflect application of IAS 19R.

3 These relate mainly to the fair value measurement of financial instruments, application of the equity method and reclassification of gains/losses on disposal of noncurrent assets to investing activities.

4 Before consolidation of intragroup transactions: €21,270 million (€17,029 million).

5 Net cash flow: cash flows from operating activities, net of cash flows from investing activities attributable to operating activities.

6 Cash and cash equivalents comprise cash at banks, checks, cash-in-hand and call deposits.

Overall, the Automotive Division recorded a cash inflow from financing activities of €1.7 billion (€2.6 billion), reflecting the lower proceeds from the issuance of bonds and higher cash outflows from the repayment of bonds compared with the previous year.

At €16.9 billion, net liquidity as of December 31, 2013 in the Automotive Division exceeded the prior-year figure by €6.3 billion.

#### FINANCIAL POSITION IN THE PASSENGER CARS BUSINESS AREA

€ million	2013	2012*
Gross cash flow	16,376	13,063
Change in working capital	1,841	1,895
Cash flows from operating activities	18,218	14,958
Cash flows from investing activities attributable to operating activities	-14,838	-14,973
Net cash flow	3,380	-15

\* Prior-year figures adjusted to reflect application of IAS 19R.

Gross cash flow in the Passenger Cars Business Area amounted to €16.4 billion in fiscal year 2013, 25.4% higher than in the previous year due to earnings-related factors and lower income tax payments. The change in working capital was on a level with the 2012 figure at €1.8 billion. Cash flows from operating activities rose by 21.8% to €18.2 billion. At €14.8 billion, the cash outflow from investing activities attributable to operating activities decreased slightly compared with the previous year (€15.0 billion), which was affected by the integration of Porsche and the acquisition of Ducati. Investments in property, plant and equipment and capitalized development costs rose to €10.0 billion (€9.2 billion) and €3.6 billion (€2.3 billion), respectively. Net cash flow improved by €3.4 billion to €3.4 billion.

#### FINANCIAL POSITION IN THE COMMERCIAL VEHICLES/ POWER ENGINEERING BUSINESS AREA

€ million	2013	2012*
Gross cash flow	2,311	2,711
Change in working capital	83	-1,438
Cash flows from operating activities	2,395	1,274
Cash flows from investing activities attributable to operating activities	-1,361	-1,482
Net cash flow	1,033	-208

\* Prior-year figures adjusted to reflect application of IAS 19R.

Gross cash flow in the Commercial Vehicles/Power Engineering Business Area was €2.3 billion, €0.4 billion less than in the previous year. Funds of €0.1 billion were released from working capital in fiscal year 2013, after funds were tied up in working capital in the previous year. Cash flows from operating activities rose by 88.0% to €2.4 billion. The cash outflow from investing activities attributable to operating activities decreased to €1.4 billion (€1.5 billion). Net cash flow improved considerably by €1.2 billion to €1.0 billion.

#### Financial position in the Financial Services Division

The Financial Services Division's gross cash flow was €5.7 billion in the year under review, up 32.6% on the previous year due to earnings-related factors. Funds tied up in working capital increased slightly year-on-year as a result of volume growth. In particular, the sale of the interest of LeasePlan to Volkswagen AG to strengthen the Financial Services Division's equity led to cash inflows from investing activities attributable to operating activities of €1.3 billion (€-0.4 billion). A cash inflow of €7.2 billion (€11.2 billion) was recorded from the issuance of bonds, among other things, to finance the increased business volumes. The Financial Services Division's negative net liquidity, which is common in the industry, amounted to €-99.2 billion (€-96.1 billion) at the end of the reporting period. This was mainly due to the expansion of business activities.

#### NET ASSETS

##### Consolidated balance sheet structure

At €324.3 billion, the Volkswagen Group's total assets as of December 31, 2013 exceeded the prior-year figure by 4.8%. The structure of the consolidated balance sheet as of the reporting date can be seen from the chart on page 102. The Volkswagen Group's equity ratio rose slightly to 27.8% (26.5%).

As of the end of the fiscal year, the Group had off-balance-sheet liabilities in the form of contingent liabilities in the amount of €4.2 billion (€4.6 billion) and other financial obligations in the amount of €24.4 billion (€22.1 billion). The latter primarily result from purchase commitments for property, plant and equipment, as well as obligations under long-term leasing and rental contracts and irrevocable credit commitments to customers.

**GROUP MANAGEMENT REPORT**  
Results of Operations, Financial Position and Net Assets

**CONSOLIDATED BALANCE SHEET BY DIVISION AS OF DECEMBER 31**

€ million	VOLKSWAGEN GROUP		AUTOMOTIVE <sup>1</sup>		FINANCIAL SERVICES	
	2013	2012 <sup>2</sup>	2013	2012 <sup>2</sup>	2013	2012 <sup>2</sup>
<b>Assets</b>						
<b>Noncurrent assets</b>	<b>202,141</b>	<b>196,457</b>	<b>122,438</b>	<b>119,651</b>	<b>79,704</b>	<b>76,805</b>
Intangible assets	59,243	59,112	59,007	58,890	236	222
Property, plant and equipment	42,389	39,424	40,632	38,004	1,757	1,420
Leasing and rental assets	22,259	20,034	2,642	2,667	19,617	17,367
Financial services receivables	51,198	49,785	-602	-602	51,800	50,387
Other receivables and financial assets <sup>3</sup>	27,053	28,101	20,759	20,693	6,294	7,409
<b>Current assets</b>	<b>122,192</b>	<b>113,061</b>	<b>68,320</b>	<b>61,282</b>	<b>53,872</b>	<b>51,779</b>
Inventories	28,653	28,674	25,580	25,868	3,073	2,806
Financial services receivables	38,386	36,911	-844	-911	39,229	37,822
Other receivables and financial assets	23,483	21,555	16,458	15,166	7,025	6,389
Marketable securities	8,492	7,433	6,675	5,697	1,817	1,736
Cash, cash equivalents and time deposits	23,178	18,488	20,450	15,462	2,728	3,026
<b>Total assets</b>	<b>324,333</b>	<b>309,518</b>	<b>190,758</b>	<b>180,934</b>	<b>133,576</b>	<b>128,584</b>
<b>Equity and Liabilities</b>						
<b>Equity</b>	<b>90,037</b>	<b>81,995</b>	<b>75,984</b>	<b>68,627</b>	<b>14,053</b>	<b>13,369</b>
Equity attributable to Volkswagen AG shareholders	85,730	77,682	72,100	64,707	13,630	12,975
Equity attributable to Volkswagen AG hybrid capital investors	2,004	-	2,004	-	-	-
Equity attributable to Volkswagen AG shareholders and hybrid capital investors	87,733	77,682	74,103	64,707	13,630	12,975
Noncontrolling interests <sup>4</sup>	2,304	4,313	1,881	3,919	423	394
<b>Noncurrent liabilities</b>	<b>115,672</b>	<b>121,996</b>	<b>65,290</b>	<b>68,603</b>	<b>50,382</b>	<b>53,394</b>
Noncurrent financial liabilities	61,517	63,603	15,913	15,069	45,604	48,534
Provisions for pensions	21,774	23,939	21,481	23,628	293	312
Other noncurrent liabilities <sup>5</sup>	32,380	34,454	27,896	29,907	4,484	4,548
<b>Current liabilities</b>	<b>118,625</b>	<b>105,526</b>	<b>49,484</b>	<b>43,704</b>	<b>69,141</b>	<b>61,822</b>
Put options and compensation rights granted to noncontrolling interest shareholders	3,638	-	3,638	-	-	-
Current financial liabilities	59,987	54,060	-3,981	-2,544	63,968	56,604
Trade payables	18,024	17,268	16,582	15,663	1,441	1,606
Other current liabilities	36,976	34,198	33,245	30,586	3,731	3,612
<b>Total equity and liabilities</b>	<b>324,333</b>	<b>309,518</b>	<b>190,758</b>	<b>180,934</b>	<b>133,576</b>	<b>128,584</b>

1 Including allocation of consolidation adjustments between the Automotive and Financial Services divisions, primarily intragroup loans.

2 Prior-year figures adjusted to reflect application of IAS 19R.

3 Including equity-accounted investments and deferred taxes.

4 Following the approval by the Annual General Meeting of MAN SE of the conclusion of a control and profit and loss transfer agreement on June 6, 2013, the noncontrolling interests in the equity of MAN SE were derecognized from Group equity as a capital transaction involving a change in ownership interest. At the same time, a liability was recognized as a separate item of current liabilities in accordance with the cash settlement offer.

5 Including deferred taxes.

**CONSOLIDATED BALANCE SHEET STRUCTURE 2013**

*in percent*

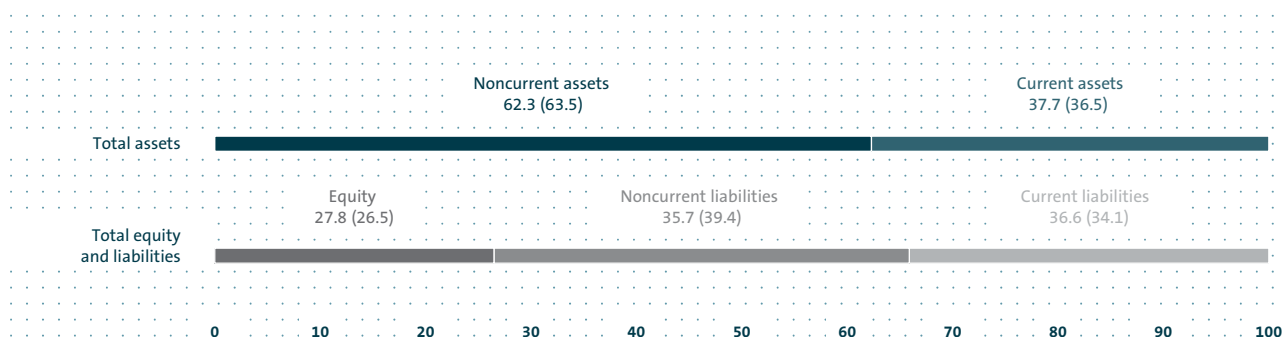

**Automotive Division balance sheet structure**

The Automotive Division's noncurrent assets – in particular intangible assets – were on a level with the previous year at the end of the reporting period. Property, plant and equipment rose by 6.9%. Within the other noncurrent assets item, equity-accounted investments rose sharply from €5.4 billion to €7.6 billion due to the acquisition of the LeasePlan interest and the strong performance of the Chinese joint ventures. Current assets were up 11.5% year-on-year; within this item, trade receivables rose by 12.8% as a result of the increase in business. Cash and cash equivalents amounted to €20.5 billion as of December 31, 2013, €5.0 billion higher than in the previous year. Following the approval by the Annual General Meeting of MAN SE of the control and profit and loss transfer agreement, a liability was recognized for the obligation to acquire the shares held by the remaining free float shareholders of MAN in accordance with the cash settlement offer in the amount of €3.1 billion. This did not affect liquidity. Equity was reduced accordingly; the noncontrolling interests in MAN SE were derecognized. The remaining noncontrolling interests are largely attributable to Scania shareholders.

The Automotive Division's equity amounted to €76.0 billion at the end of 2013, up 10.7% on the prior-year figure. The increase was attributable to positive earnings growth, lower actuarial losses from the measurement of pension provisions, the issuance of a mandatory convertible note and the hybrid notes, as well as positive effects from the fair value measurement of derivative financial instruments. Effects from the derecognition of the noncontrolling interests in MAN SE, dividend payments and foreign exchange

differences had an offsetting effect. The division's equity ratio rose year-on-year to 39.8% (37.9%).

At €65.3 billion, noncurrent liabilities declined by 4.8% as against December 31, 2012. This figure includes provisions for pensions, which decreased by €2.1 billion to €21.5 billion as a result of the actuarial remeasurement. Following the derecognition of the noncontrolling interests in MAN, a liability in the amount of €3.1 billion was recognized under the position "Put options and compensation rights granted to noncontrolling interest shareholders" in current liabilities for the obligation to acquire the shares held by the remaining free float shareholders of MAN in accordance with the cash settlement offer. Following the opening of the award proceedings in connection with the control and profit and loss transfer agreement with MAN SE, this obligation had to be increased by the expected present value of the minimum statutory interest rate in the amount of €0.5 billion. Current liabilities were up on the previous year at €49.5 billion (€43.7 billion). The increase was mainly attributable to reclassifications from noncurrent to current liabilities due to shorter remaining maturities. The figures for the Automotive Division also contain the elimination of intragroup transactions between the Automotive and Financial Services divisions. As the current financial liabilities for the primary Automotive Division were lower than the loans granted to the Financial Services Division, a negative amount was disclosed for the reporting period.

Total assets were €190.8 billion as of December 31, 2013, 5.4% higher than at year-end 2012.

**PASSENGER CARS BUSINESS AREA BALANCE SHEET STRUCTURE**

€ million	2013	2012*
Noncurrent assets	94,873	90,844
Current assets	50,146	42,949
<b>Total assets</b>	<b>145,019</b>	<b>133,794</b>
Equity	60,494	49,154
Noncurrent liabilities	52,900	54,608
Current liabilities	31,625	30,032

\* Prior-year figures adjusted to reflect application of IAS 19R.

At €94.9 billion, noncurrent assets in the Passenger Cars Business Area were up 4.4% on the prior-year figure. This was attributable to the increase in property, plant and equipment as a result of the comprehensive investment program, as well as an increase in equity-accounted investments from the acquisition of the LeasePlan interest and the positive performance of the Chinese joint ventures. Current assets rose by 16.8% to €50.1 billion, mainly due to the increase in cash and cash equivalents. Total assets amounted to €145.0 billion (€133.8 billion) as of December 31, 2013.

Equity rose by 23.1% to €60.5 billion. Noncurrent liabilities declined by 3.1%, while current liabilities rose by 5.3%.

**COMMERCIAL VEHICLES/POWER ENGINEERING BUSINESS AREA BALANCE SHEET STRUCTURE**

€ million	2013	2012*
Noncurrent assets	27,565	28,807
Current assets	18,174	18,333
<b>Total assets</b>	<b>45,739</b>	<b>47,140</b>
Equity	15,490	19,473
Noncurrent liabilities	12,390	13,994
Current liabilities	17,859	13,673

\* Prior-year figures adjusted to reflect application of IAS 19R.

At the end of the reporting period, noncurrent assets in the Commercial Vehicles/Power Engineering Business Area were down year-on-year, while current assets were on a level with the previous year. Total assets declined slightly to €45.7 billion (€47.1 billion).

At €15.5 billion, equity was 20.5% lower than the prior-year figure. In connection with the control and profit and loss transfer agreement with MAN SE, equity was reduced by the €3.1 billion obligation to acquire the shares held by the remaining free float shareholders of MAN, which was recognized as a current liability. The expected present value of the minimum statutory interest rate (€0.5 billion) was also reported under this item. Noncurrent liabilities declined as against December 31, 2012, while current liabilities were 30.6% higher at the end of fiscal year 2013.

**Financial Services Division balance sheet structure**

The Financial Services Division's total assets amounted to €133.6 billion on December 31, 2013, 3.9% higher than at year-end 2012.

Both leasing and rental assets and noncurrent financial services receivables rose as a result of the increase in business. The sale of the interest in LeasePlan led to a decline in equity-accounted investments. Overall, noncurrent assets increased by 3.8% compared with December 31, 2012. Current assets rose by 4.0%. Current financial services receivables increased by €1.4 billion to €39.2 billion. The Financial Services Division accounted for 41.2% of the Volkswagen Group's assets at the end of fiscal year 2013.

At €14.1 billion, the Financial Services Division's equity at the reporting date was up 5.1% on the previous year due to an improved earnings situation. The division's equity ratio rose to 10.5% (10.4%). The shorter remaining maturities of financial liabilities in particular saw noncurrent liabilities decline by 5.6% as against year-end 2012, while current liabilities rose by 11.8%. Deposits from direct banking business amounted to €23.3 billion (€23.9 billion); of this figure, €22.3 billion was attributable to Volkswagen Bank direct. The debt to equity ratio remained unchanged at 8:1.

**GROUP MANAGEMENT REPORT**  
Results of Operations, Financial Position and Net Assets

**FINANCIAL KEY PERFORMANCE INDICATORS**

%	2013	2012 <sup>1</sup>	2011	2010	2009
<b>Volkswagen Group</b>					
Gross margin	18.1	18.2	17.6	16.9	12.9
Personnel expense ratio	16.1	15.3	15.0	15.0	15.2
Return on sales before tax	6.3	13.2	11.9	7.1	1.2
Return on sales after tax	4.6	11.4	9.9	5.7	0.9
Equity ratio	27.8	26.5	25.0	24.4	21.1
Dynamic gearing (years) <sup>2</sup>	0.1	0.1	0.1	0.1	0.2
<b>Automotive Division<sup>3</sup></b>					
Change in unit sales <sup>4</sup>	+ 4.1	+ 11.8	+ 14.9	+ 15.4	+ 0.6
Change in sales revenue	+ 1.3	+ 21.6	+ 26.0	+ 21.2	- 9.3
Operating profit as a percentage of sales revenue	5.6	5.7	7.0	5.5	1.4
EBITDA (in € million) <sup>5</sup>	20,594	19,895	17,815	13,940	8,005
Return on investment (ROI) <sup>6</sup>	14.5	16.6	17.7	13.5	3.8
Cash flows from operating activities as a percentage of sales revenue	11.8	9.4	12.0	12.3	13.8
Cash flows from investing activities as a percentage of sales revenue	9.3	9.5	11.3	8.1	11.0
Investments in property, plant and equipment as a percentage of sales revenue	6.3	5.9	5.6	5.0	6.2
Ratio of noncurrent assets to total assets <sup>7</sup>	21.3	21.0	21.5	22.8	24.9
Ratio of current assets to total assets <sup>8</sup>	13.4	14.3	17.4	14.7	13.8
Inventory turnover	6.5	6.4	6.9	7.4	6.0
Equity ratio	39.8	37.9	35.9	35.5	30.2
<b>Financial Services Division</b>					
Increase in total assets	3.9	19.5	22.5	9.2	1.6
Return on equity before tax <sup>9</sup>	14.3	13.1	14.0	12.9	7.9
Equity ratio	10.5	10.4	10.1	10.4	10.2

1 Prior-year figures adjusted to reflect application of IAS 19R.

2 Ratio of cash flows from operating activities to current and noncurrent financial liabilities.

3 Including allocation of consolidation adjustments between the Automotive and Financial Services divisions.

4 Including the Shanghai-Volkswagen Automotive Company Ltd. and FAW-Volkswagen Automotive Company Ltd. vehicle-production investments. These companies are accounted for using the equity method.

5 Operating profit plus net depreciation/amortization and impairment losses/reversals of impairment losses on property, plant and equipment, capitalized development costs, leasing and rental assets, goodwill and financial assets as reported in the cash flow statement.

6 For details, see Value-based management on page 108.

7 Ratio of property, plant and equipment to total assets.

8 Ratio of inventories to total assets.

9 Profit before tax as a percentage of average equity.



**SUMMARY OF ECONOMIC POSITION**

The Board of Management of Volkswagen AG believes that the Group's economic position is positive. Alongside our primary business, the initial full-year consolidation of Dr. Ing. h.c. F. Porsche AG in the Volkswagen Group helped us to exceed the previous year's record sales revenue and operating profit and thus maintain our profitable growth trajectory. We continued to pursue disciplined cost and investment management and the continuous optimization of our processes in the year under review.

In fiscal year 2013, we entered into a control and profit and loss transfer agreement with MAN SE to enable Volkswagen and MAN to strengthen and simplify their cooperation, increasing the competitiveness of both companies.

Volkswagen Group's capital base was strengthened in the reporting period by the successful issue of a mandatory convertible note with an aggregate principal amount of €1.2 billion in June 2013, which supplemented the mandatory convertible note issued in November 2012, and the placement of dual-tranche hybrid notes with an aggregate principal amount of €2.0 billion in August 2013,

which were well received by the market. The Automotive Division's strong liquidity position at the end of fiscal year 2013 gives us financial stability and flexibility.

An overview of the development of the Volkswagen Group over the past five years can be found in the tables on pages 104 and 106. More information on the economic position of the Volkswagen Group by brand and business field can be found in the Divisions chapter starting on page 21.

**VALUE ADDED STATEMENT**

The value added statement indicates the added value generated by a company in the past fiscal year as its contribution to the gross domestic product of its home country, and how it is appropriated. The value added generated by the Volkswagen Group in the year under review was 19.2% lower than in the previous year, as measurement effects from the integration of Porsche had a positive effect on other income. Added value per employee in 2013 was €98.4 thousand (-22.6%). Employees in the passive phase of their partial retirement are not included in the calculation.

**VALUE ADDED GENERATED BY THE VOLKSWAGEN GROUP**

Source of funds in € million	2013	2012*
Sales revenue	197,007	192,676
Other income	13,994	24,642
Cost of materials	-127,089	-122,450
Depreciation and amortization	-14,686	-13,135
Other upfront expenditures	-21,027	-22,070
<b>Value added</b>	<b>48,198</b>	<b>59,663</b>

Appropriation of funds in € million	2013	%	2012*	%
to shareholders (dividend)	1,871	3.9	1,639	2.8
to employees (wages, salaries, benefits)	31,747	65.9	29,504	49.5
to the state (taxes, duties)	3,865	8.0	4,322	7.2
to creditors (interest expense)	3,442	7.1	3,957	6.6
to the Company (reserves)	7,274	15.1	20,242	33.9
<b>Value added</b>	<b>48,198</b>	<b>100.0</b>	<b>59,663</b>	<b>100.0</b>

\* Prior-year figures adjusted to reflect application of IAS 19R.

**GROUP MANAGEMENT REPORT**  
Results of Operations, Financial Position and Net Assets

**FIVE-YEAR REVIEW**

	2013	2012*	2011	2010	2009
<b>Volume Data (thousands)</b>					
<b>Vehicle sales (units)</b>	<b>9,728</b>	<b>9,345</b>	<b>8,361</b>	<b>7,278</b>	<b>6,310</b>
Germany	1,187	1,207	1,211	1,059	1,288
Abroad	8,541	8,137	7,150	6,219	5,022
<b>Production (units)</b>	<b>9,728</b>	<b>9,255</b>	<b>8,494</b>	<b>7,358</b>	<b>6,055</b>
Germany	2,458	2,321	2,640	2,115	1,938
Abroad	7,270	6,934	5,854	5,243	4,117
<b>Employees (yearly average)</b>	<b>563</b>	<b>533</b>	<b>454</b>	<b>389</b>	<b>367</b>
Germany	255	237	196	178	173
Abroad	308	296	258	210	194
<b>Financial Data (in € million)</b>					
<b>Income Statement</b>					
<b>Sales revenue</b>	<b>197,007</b>	<b>192,676</b>	<b>159,337</b>	<b>126,875</b>	<b>105,187</b>
Cost of sales	161,407	157,522	131,371	105,431	91,608
<b>Gross profit</b>	<b>35,600</b>	<b>35,154</b>	<b>27,965</b>	<b>21,444</b>	<b>13,579</b>
Distribution expenses	19,655	18,850	14,582	12,213	10,537
Administrative expenses	6,888	6,220	4,384	3,287	2,739
Net other operating income	2,613	1,415	2,271	1,197	1,553
<b>Operating profit</b>	<b>11,671</b>	<b>11,498</b>	<b>11,271</b>	<b>7,141</b>	<b>1,855</b>
Financial result	757	13,989	7,655	1,852	-595
<b>Profit before tax</b>	<b>12,428</b>	<b>25,487</b>	<b>18,926</b>	<b>8,994</b>	<b>1,261</b>
Income tax expense	3,283	3,606	3,126	1,767	349
<b>Profit after tax</b>	<b>9,145</b>	<b>21,881</b>	<b>15,799</b>	<b>7,226</b>	<b>911</b>
<b>Cost of materials</b>	<b>127,089</b>	<b>122,450</b>	<b>104,648</b>	<b>79,394</b>	<b>67,925</b>
<b>Personnel expenses</b>	<b>31,747</b>	<b>29,504</b>	<b>23,854</b>	<b>19,027</b>	<b>16,027</b>
<b>Balance Sheet (at December 31)</b>					
Noncurrent assets	202,141	196,457	148,129	113,457	99,402
Current assets	122,192	113,061	105,640	85,936	77,776
<b>Total assets</b>	<b>324,333</b>	<b>309,518</b>	<b>253,769</b>	<b>199,393</b>	<b>177,178</b>
Equity	90,037	81,995	63,354	48,712	37,430
of which: noncontrolling interests	2,304	4,313	5,815	2,734	2,149
Noncurrent liabilities	115,672	121,996	89,179	73,781	70,215
Current liabilities	118,625	105,526	101,237	76,900	69,534
<b>Total equity and liabilities</b>	<b>324,333</b>	<b>309,518</b>	<b>253,769</b>	<b>199,393</b>	<b>177,178</b>
<b>Cash flows from operating activities</b>	<b>12,595</b>	<b>7,209</b>	<b>8,500</b>	<b>11,455</b>	<b>12,741</b>
<b>Cash flows from investing activities attributable to operating activities</b>	<b>14,936</b>	<b>16,840</b>	<b>16,002</b>	<b>9,278</b>	<b>10,428</b>
<b>Cash flows from financing activities</b>	<b>8,973</b>	<b>13,712</b>	<b>8,316</b>	<b>-852</b>	<b>5,536</b>

\* Prior-year figures adjusted to reflect application of IAS 19R.

#### RETURN ON INVESTMENT (ROI) AND VALUE CONTRIBUTION

The Volkswagen Group's financial target system centers on continuously and sustainably increasing the value of the Company. We have been using the return on investment (RoI) and value contribution\*, a key performance indicator linked to the cost of capital, for a number of years, in order to use resources in the Automotive Division efficiently and to measure the success of this.

The concept of value-based management allows the success of our innovative, environmentally oriented product portfolio to be evaluated. This concept also enables the earnings strength of individual business units and projects, such as the new plants in India, Russia and North America, to be measured.

#### Components of value contribution

Value contribution is calculated using operating profit after tax and the opportunity cost of invested capital. Operating profit shows the economic performance of the Automotive Division and is initially a pre-tax figure.

Using the various international income tax rates of the relevant companies, we assume an overall average tax rate of 30% when calculating the operating profit after tax.

The cost of capital is multiplied by the invested capital to give the opportunity cost of capital. Invested capital is calculated as total operating assets (property, plant and equipment, intangible assets, inventories and receivables) less non-interest-bearing liabilities (trade payables and payments on account received).

As the concept of value-based management only comprises our operating activities, assets relating to investments in subsidiaries and associates and the investment of cash funds are not included when calculating invested capital. Interest charged on these assets is reported in the financial result.

#### Determining the current cost of capital

The cost of capital is the weighted average of the required rates of return on equity and debt. The cost of equity is determined using the Capital Asset Pricing Model (CAPM).

This model uses the yield on long-term risk-free Bunds, increased by the risk premium attaching to investments in the equity market. The risk premium comprises a general market risk and a specific business risk.

The general risk premium of 6.5% reflects the general risk of a capital investment in the equity market and is oriented on the Morgan Stanley Capital International (MSCI) World Index.

Since 2010, the specific business risk – price fluctuations in Volkswagen preferred shares – has been modeled when calculating the beta factor in comparison to the MSCI World Index.

The switch in benchmark index from the DAX to the MSCI World Index was necessary because Volkswagen shares experienced considerable price fluctuations in 2008 and 2009, and the share class in the DAX was changed to preferred shares in 2010. The MSCI World Index sets a standard that reflects a global capital market benchmark for investors.

The analysis period for the beta factor calculation spans five years with annual beta figures on a daily basis and an average subsequently being calculated. A beta factor of 1.32 was determined for 2013 (1.26).

#### COST OF CAPITAL AFTER TAX AUTOMOTIVE DIVISION

%	2013	2012
Risk-free rate	2.6	2.2
MSCI World Index market risk premium	6.5	6.5
Volkswagen-specific risk premium	2.1	1.7
(Volkswagen beta factor)	(1.32)	(1.26)
<b>Cost of equity after tax</b>	<b>11.2</b>	<b>10.4</b>
Cost of debt	3.7	3.7
Tax	-1.1	-1.1
<b>Cost of debt after tax</b>	<b>2.6</b>	<b>2.6</b>
Proportion of equity	66.7	66.7
Proportion of debt	33.3	33.3
<b>Cost of capital after tax</b>	<b>8.3</b>	<b>7.8</b>

The cost of debt is based on the average yield for long-term debt. As borrowing costs are tax-deductible, the cost of debt is adjusted to account for the tax rate of 30%.

A weighting on the basis of a fixed ratio for the fair values of equity and debt gives an effective cost of capital for the Automotive Division of 8.3% (7.8%) for 2013.

\* The value contribution corresponds to the Economic Value Added (EVA®). EVA® is a registered trademark of Stern Stewart & Co.

**RETURN ON INVESTMENT (ROI) AND VALUE CONTRIBUTION IN THE REPORTING PERIOD**

The operating profit after tax of the Automotive Division, including the proportionate operating profit of the Chinese joint ventures, was €10,536 million (€10,904 million) in fiscal year 2013. The year-on-year decline was mainly caused by deteriorations in exchange rates, higher depreciation charges as a result of increased capital expenditures, higher research and development costs, and contingency reserves in the Passenger Cars and Power Engineering areas. The initial full-year consolidation of Porsche, optimized product costs as well as a considerably improved proportionate operating profit of the Chinese joint ventures had a positive effect compared with the prior year. Effects on earnings and assets from purchase price allocation are not taken into account as this is beyond what is feasible from an operational management perspective.

Invested capital rose to €72,749 million (€65,749 million), mainly due to the full effect of the consolidation of Porsche, as well as higher investments in property, plant and equipment.

The return on investment (RoI) is the return on invested capital for a particular period based on the operating profit after tax. It decreased in 2013 as against the previous year, but at 14.5% (16.6%) was still well above our minimum required rate of return of 9%.

The opportunity cost of capital – invested capital multiplied by the cost of capital, which increased as against 2012 – was up on the prior-year level at €6,038 million (€5,128 million). In conjunction with the lower operating profit after tax, this led to a declining but clearly positive value contribution of €4,497 million (€5,775 million).

More information on value-based management is contained in our publication entitled “Financial Control System of the Volkswagen Group”, which can be downloaded from our Investor Relations website: [www.volkswagenag.com/ir](http://www.volkswagenag.com/ir)

**RETURN ON INVESTMENT (ROI) AND VALUE CONTRIBUTION IN THE AUTOMOTIVE DIVISION<sup>1</sup>**

€ million	2013	2012 <sup>2</sup>
<b>Operating profit after tax</b>	<b>10,536</b>	<b>10,904</b>
Invested capital (average)	72,749	65,749
<b>Return on investment (ROI) in %</b>	<b>14.5</b>	<b>16.6</b>
Cost of capital in %	8.3	7.8
<b>Cost of invested capital</b>	<b>6,038</b>	<b>5,128</b>
<b>Value contribution</b>	<b>4,497</b>	<b>5,775</b>

<sup>1</sup> Including proportionate inclusion of the Chinese joint ventures (including the relevant sales and component companies) and allocation of consolidation adjustments between the Automotive and Financial Services Divisions.

<sup>2</sup> Prior-year figures adjusted to reflect application of IAS 19R.

# Volkswagen AG

(CONDENSED, IN ACCORDANCE WITH THE GERMAN COMMERCIAL CODE)

Vehicle production up year-on-year,  
sales and earnings below prior-year figures.

## NET INCOME FOR THE YEAR

At €65.6 billion, Volkswagen AG's sales in the reporting period were down 4.1% on the previous year. The proportion of sales generated outside Germany was 62.8% (63.5%). The 2.4% decrease in cost of sales to €61.9 billion resulted in gross profit of €3.6 billion (€4.9 billion).

Selling, general and administrative expenses were 1.7% higher in fiscal year 2013 than in the previous year, at €6.1 billion; the ratio of selling, general and administrative expenses to sales rose to 9.3% (8.8%).

Other operating result amounted to €0.9 billion (€1.3 billion).

The financial result declined by 22.6% year-on-year to €6.1 billion, due in particular to lower income from investments.

Volkswagen AG's result from ordinary activities decreased overall to €4.6 billion (€8.1 billion) in 2013. After deducting income taxes, net income for the year was €3.1 billion.

## INCOME STATEMENT OF VOLKSWAGEN AG

€ million	2013	2012
Sales	65,587	68,361
Cost of sales	61,937	63,458
<b>Gross profit on sales</b>	<b>+ 3,650</b>	<b>+ 4,903</b>
Selling, general and administrative expenses	6,088	5,986
Other operating result	+ 944	+ 1,264
Financial result*	+ 6,115	+ 7,904
<b>Result from ordinary activities</b>	<b>+ 4,620</b>	<b>+ 8,084</b>
Taxes on income	1,542	1,704
<b>Net income for the year</b>	<b>3,078</b>	<b>6,380</b>
Retained profits brought forward	6	10
Appropriations to revenue reserves	1,210	3,190
<b>Net retained profits</b>	<b>1,874</b>	<b>3,200</b>

\* Including write-downs of financial assets.

## BALANCE SHEET OF VOLKSWAGEN AG AS OF DECEMBER 31

€ million	2013	2012
Fixed assets	69,931	61,096
Inventories	3,695	3,795
Receivables*	22,132	19,347
Cash-in-hand and bank balances	11,279	6,880
<b>Total assets</b>	<b>107,037</b>	<b>91,118</b>
Equity	25,874	24,434
Special tax-allowable reserves	41	47
Long-term debt	16,450	14,102
Medium-term debt	29,602	26,222
Short-term debt	35,070	26,312

\* Including prepaid expenses.

#### NET ASSETS AND FINANCIAL POSITION

Total assets amounted to €107.0 billion at December 31, 2013, €15.9 billion higher than in the previous year. Investments in tangible and intangible assets were on a level with the previous year, at €2.5 billion. Investments in financial assets amounting to €19.9 billion (€9.7 billion) also include the interest in Truck & Bus GmbH. At €69.9 billion, fixed assets exceeded the 2012 figure by 14.5% at the balance sheet date.

Current assets (including prepaid expenses) amounted to €37.1 billion, surpassing the prior-year figure by €7.1 billion, mainly due to higher liquid assets and the increase in receivables from affiliated companies.

Equity amounted to €25.9 billion at year-end 2013. The 5.9% increase was largely the result of the net income.

The equity ratio was 24.2% (26.8%). Provisions increased by a total of €0.8 billion on the previous year. This is primarily attributable to higher pension provisions. Other provisions increased by €0.2 billion to €11.1 billion, while provisions for taxes rose by €0.1 billion to €5.0 billion. Higher liabilities to affiliated companies in particular saw total liabilities (including deferred income) rise by 35.2% as against December 31, 2012, to €52.6 billion.

The interest-bearing portion of debt rose to €45.1 billion (€33.1 billion).

In our assessment, the economic position of Volkswagen AG is just as positive as that of the Volkswagen Group.

#### DIVIDEND PROPOSAL

In accordance with section 58(2) of the Aktiengesetz (AktG – German Stock Corporation Act), €1,210 million of the net income for the year was appropriated to other revenue reserves. The Board of Management and Supervisory Board are proposing to the Annual General Meeting to pay a dividend of €1.9 billion from net retained profits, i.e. €4.00 per ordinary share and €4.06 per preferred share.

#### PROPOSAL ON THE APPROPRIATION OF NET PROFIT

€	2013
Dividend distribution on subscribed capital (€1,191 million)	1,871,160,846.26
of which on: ordinary shares	1,180,359,272.00
preferred shares	690,801,574.26
Balance (carried forward to new account)	3,295,735.06
<b>Net retained profits</b>	<b>1,874,456,581.32</b>

#### EMPLOYEE PAY AND BENEFITS AT VOLKSWAGEN AG

€ million	2013	%	2012	%
Direct pay including cash benefits	6,545	71.4	6,481	70.4
Social security contributions	1,116	12.2	1,073	11.7
Compensated absence	930	10.1	868	9.4
Retirement benefits	579	6.3	778	8.5
<b>Total expense</b>	<b>9,170</b>	<b>100.0</b>	<b>9,200</b>	<b>100.0</b>

#### SALES TO THE DEALER ORGANIZATION

Volkswagen AG sold a total of 2,495,745 vehicles to the dealer organization in fiscal year 2013, down on the previous year (-3.3%). The proportion of vehicles sold outside Germany was 70.5% (70.0%).

#### PRODUCTION

Volkswagen AG produced a total of 1,169,151 vehicles at its vehicle production plants in Wolfsburg, Hanover and Emden in the reporting period, 1.8% more than in the previous year. Volkswagen AG's average daily production was higher than the previous year at 5,095 units.

#### NUMBER OF EMPLOYEES

As of December 31, 2013, a total of 107,559 people were employed at the sites of Volkswagen AG, excluding staff employed at subsidiaries. Of this figure, 4,942 were vocational trainees. 5,549 employees were in the passive phase of their partial retirement. The workforce grew by 5.7% as against the prior-year reporting date.

Female employees accounted for 15.8% of the workforce. Volkswagen AG employed 3,590 part-time workers (3.3%). The percentage of foreign employees was 5.9%. The proportion of employees in the production area who have completed vocational training relevant for Volkswagen was 83.0%. 17.3% of the employees were graduates. The average age of employees in fiscal year 2013 was 42.9 years.

#### RESEARCH AND DEVELOPMENT

Research and development costs for Volkswagen AG under the German Commercial Code amounted to €4.4 billion (€3.8 billion) in 2013. 11,181 people were employed in this area at the end of the reporting period.

#### PURCHASING VOLUME

The purchasing volume across the six Volkswagen AG sites in Germany amounted to €26.2 billion in fiscal year 2013 (€26.6 billion); the proportion attributable to German suppliers was 68.1% (68.4%). Of the total purchasing volume, €21.1 billion was spent on production materials and €5.1 billion on capital goods and services.

#### EXPENDITURE ON ENVIRONMENTAL PROTECTION

Expenditure on environmental protection is split between investments and operating costs. Of our total investments, those that are spent exclusively or primarily on environmental protection are included in environmental protection investments. We distinguish here between additive and integrated investments. Additive environmental protection measures are separate investments that are independent of other investments relating to the production process. They can be upstream or downstream of the production process. In contrast to additive environmental protection measures, the environmental impact is already reduced during production in the case of integrated measures. Our focus in 2013 was on water pollution control.

Operating costs for environmental protection relate exclusively to production-related measures that protect the environment against harmful factors by avoiding, reducing, or eliminating emissions by the Company, or conserving resources. These entail both expenses associated with the operation of equipment that protects the environment as well as expenditures for measures not relating to such equipment. Our focus in 2013 was on water pollution control, waste management and air pollution control.

#### VOLKSWAGEN AG EXPENDITURE ON ENVIRONMENTAL PROTECTION

€ million	2013	2012	2011	2010	2009
Investments	14	9	18	12	10
Operating costs	224	216	200	197	180

**OPERATING COSTS FOR ENVIRONMENTAL PROTECTION AT VOLKSWAGEN AG 2013**

Share of environmental protection areas in percent

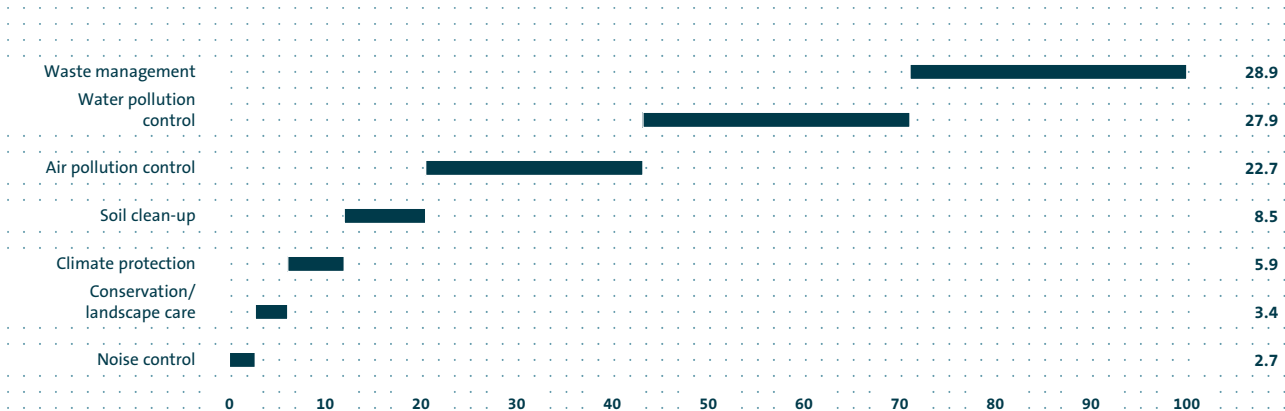

**BUSINESS DEVELOPMENT RISKS AND OPPORTUNITIES AT VOLKSWAGEN AG**

The business development of Volkswagen AG is exposed to essentially the same risks and opportunities as the Volkswagen Group. These risks and opportunities are explained in the Report on Risks and Opportunities on pages 151 to 163 of this annual report.

**RISKS ARISING FROM FINANCIAL INSTRUMENTS**

Risks for Volkswagen AG arising from the use of financial instruments are the same as those to which the Volkswagen Group is exposed. An explanation of these risks can be found on pages 162 to 163 of this annual report.

**DEPENDENT COMPANY REPORT**

The Board of Management of Volkswagen AG has submitted to the Supervisory Board the report required by section 312 of the AktG and issued the following concluding declaration:

“We declare that, based on the circumstances known to us at the time when the transactions with affiliated companies within the meaning of section 312 of the German Stock Corporation Act (AktG) were entered into, our Company received appropriate consideration for each transaction. No transactions with third parties or measures were either undertaken or omitted on the instructions of or in the interests of Porsche or other affiliated companies in the reporting period.”



# Sustainable Value Enhancement

Our corporate governance is geared towards sustainable value enhancement. We take responsibility along the entire value chain for our customers, our employees, society and the environment.

The main financial key performance indicators for the Volkswagen Group are described in the “Results of Operations, Financial Position and Net Assets” chapter. Nonfinancial key performance indicators also attest to the effectiveness of our Company’s value drivers. These include our processes in the areas of research and development, procurement, production, marketing and sales, information technology and quality assurance. In all of these processes, we are constantly aware of our responsibility towards our customers, our employees, society and the environment. In this chapter, we show how we increase the value of our Company in a sustainable way using examples from the areas mentioned.

## CORPORATE SOCIAL RESPONSIBILITY AND SUSTAINABILITY

Thanks to its corporate culture, Volkswagen is better suited than almost any other company to combine a modern understanding of responsibility and sustainability with the traditional values of running a business to form an integrated CSR approach.

In the traditional sense, corporate social responsibility (CSR) means that a company actively contributes to charitable measures and social welfare, in the form of donations or corporate volunteering. Although such a contribution is expected of a company, it is a voluntary service in recognition of its social responsibility. Today, CSR is considered to be an integrated component of a company’s core competency. CSR is therefore oriented on Volkswagen’s strategic goals and comprises a concept of corporate responsibility along the entire value chain. While under the traditional definition of CSR, various stakeholders ask how funds are used, the question posed under the new definition is how a company generates its funds. This relates both to responsibility for social and ecological standards at the company’s own production sites and along the supply chain, and for the product itself.

Sustainability means simultaneously striving for economic, social and environmental goals in a way that gives them equal priority. Consequently, to us this means creating enduring value,

facilitating good work, and using the environment and resources with care. Our integrated CSR concept is aimed at ensuring that we recognize and manage at an early stage risks and development opportunities in the areas of environment, society and governance at every step along the value chain, and further improve our reputation. This is how CSR contributes to increasing our Company’s value in a long-term and sustainable way.

## Management and coordination

Our integrated CSR management concept is closely linked with the functional areas at all levels of the Company. The Group Board of Management is also the supreme sustainability board in the Company. It regularly receives information on the issues of responsibility and sustainability from the Group CSR & Sustainability steering group, whose members include senior executives from central Board of Management business areas in addition to the Group Works Council and representatives of the brands and regions. This steering group is responsible for our sustainability strategy, on the basis of which the Group aims to become the most sustainable automaker in the world by 2018. The steering group formulates the strategic goals and statements on CSR and sustainability, establishes and monitors the Company-wide CSR management indicators, and makes decisions about sustainability reporting.

Since 2006, our CSR & Sustainability office has coordinated all CSR activities within the Group and the brands, using standardized structures, processes and reports. It strategically aligns the CSR activities and guides internal management processes and stakeholder relationships. The CSR project teams in the Group as well as the brands and regions work on current topics across business areas, such as sustainability in supplier relationships and stakeholder management. Since 2009, the international CSR coordinators of all brands and regions have exchanged information each year.

With our IT-based sustainability management system and the integration of key performance indicator systems, we have created the basis for comprehensive and timely CSR and sustainability reporting in the Group. This increases transparency and the quality of the data, so that we can monitor CSR risks more easily and identify opportunities.

#### Code of Conduct and guidelines

Our Code of Conduct, which is applicable throughout the Group, provides guidance for our employees in the event of legal and ethical challenges in their daily work. It embodies the Group values of closeness to customers, maximum performance, creating value, renewability, respect, responsibility and sustainability. All employees are equally responsible for adhering to these principles.

International conventions, regulations and internal rules are also key guidelines for our conduct. We also acknowledge our commitment to the “Declaration on Social Rights and Industrial Relationships at Volkswagen” (Volkswagen Social Charter), the Charter on Labor Relations and the Temporary Work Charter, all of which address fundamental human rights, labor standards and principles.

#### Strategic stakeholder management

Volkswagen continually exchanges information and views with its stakeholders, whose diverse demands and expectations directly affect the Group’s economic success and therefore flow into the Company’s knowledge management processes at an early stage. In order to meet such requirements in a targeted way, we developed a stakeholder management concept, which analyzes economic, ecological and social challenges in a systematic process along our value chain. We communicate with the various stakeholders openly, constructively and equitably. We use many instruments to do this: dialogs, workshops, symposiums, public debates, social media, questionnaires, evaluations and projects.

We document stakeholder dialogs in an IT-based stakeholder management system that is customized for the Volkswagen Group, and publish them in our annual sustainability report to make our interaction with stakeholders transparent and understandable. Stakeholder management is steered and coordinated by the Group CSR & Sustainability steering group, the Group’s project team, and the brands and regions. Since we selectively choose relevant departments for the project teams, we are also able to respond to the many requirements of the stakeholders concerned within a short time.

A key component of external stakeholder management is the ability to help shape national and international corporate networks: we are represented on the board of the leading European business network for corporate social responsibility, CSR Europe, for example. Within Germany, we are represented on the board of econsense, the Forum for Sustainable Development of German Business. Along with numerous other companies, we have signed the “Code of Responsible Conduct for Business” initiative.

Since 2002, we have also been committed to the UN Global Compact, the largest and most important CSR initiative in the world. Over 10,000 companies and other stakeholders from more than 130 countries work together to shape a more sustainable and equitable world economy. The Volkswagen Group and its brands make a significant contribution to this initiative. Scania reinforced this by signing the Global Compact in 2013.

The values of the Global Compact comprise ten principles governing human rights, labor standards, environmental protection and the fight against corruption. We achieved the “Global Compact Advanced Level” in 2013 again due to our progress report on implementing these principles at our locations. Furthermore, we use our expertise to help other companies in the Global Compact to embrace their global responsibility, for example through our active participation as a standing member of the advisory board for the “Sustainable Supplier Chain” project.

In 2013, Volkswagen became the first automotive company in the world to sign the CEO Water Mandate. This sub-initiative of the UN Global Compact is a multi-stakeholder organization that tackles the many problems related to water worldwide with the cooperation of companies, the UN Secretariat, nongovernmental organizations and governments, and develops long-term solutions.

#### Materiality matrix

We learn which issues are important for the security of the Company’s future from our comprehensive dialog with our stakeholders. We systematically evaluate these issues using the latest international sustainability studies and benchmark them against the guidelines and conventions that Volkswagen is committed to. Internal bodies discuss and weight the issues identified as part of a continual materiality analysis process. We discuss these important challenges for our Company and the automotive industry in detail at both brand and Group level. The result is the map for our sustainability strategy: a matrix of the key issues.

MATERIALITY ANALYSIS: TOPICS FOR THE VOLKSWAGEN GROUP

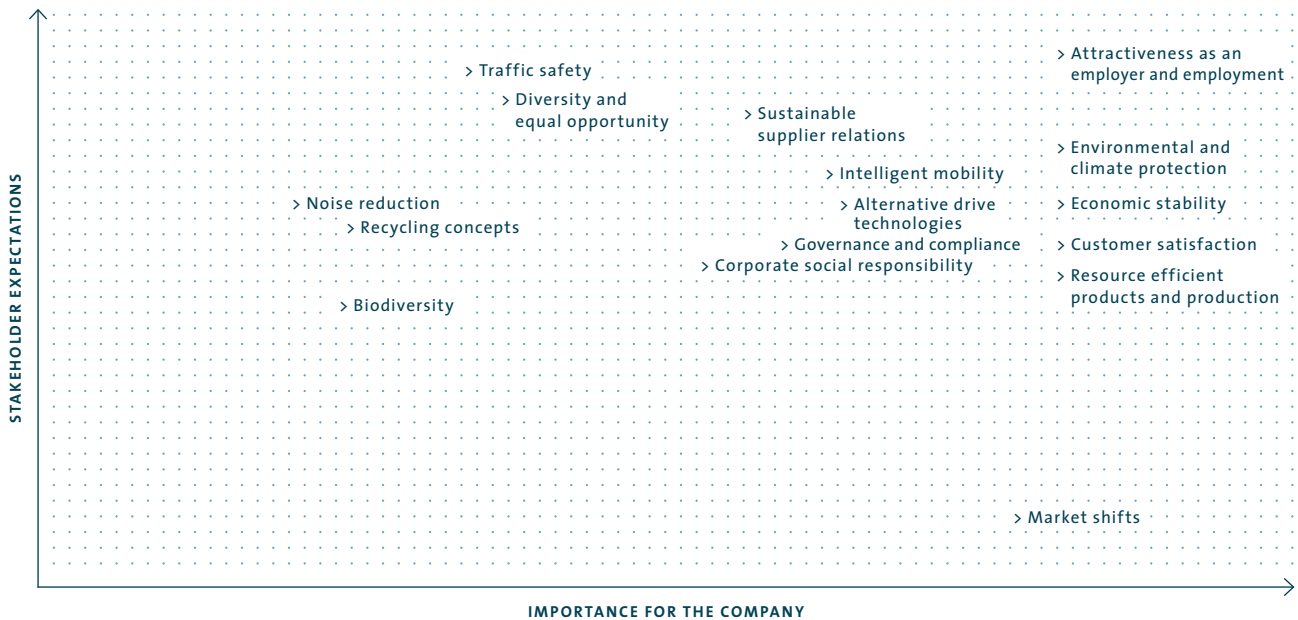

CSR Projects

The many and varied CSR projects initiated and managed by the Volkswagen Group around the world are based on the following key principles:

- > They are compatible with the Group's principles while at the same time addressing a specific local or regional issue.
- > They demonstrate the diversity in the Group and in the social environment in which the projects are implemented.
- > They are the result of close stakeholder dialog with the local players involved in implementation.
- > Project management is the responsibility of the local units working on the project.

The Volkswagen Group supports a large number of projects that promote the arts and culture, education, science, health and sport, or that serve to develop regional structures and conserve nature. These projects make CSR a learning platform for all brands and in all of the Company's regions. Our extensive cooperation with the German Red Cross and the German Nature and Biodiversity Conservation Union (NABU) are good examples of this.

The German Red Cross represents an idea that is just as topical today as it was 150 years ago: people helping fellow people in need. Humanity, public spirit and responsibility – these are the values on which Germany's largest mass movement with the richest tradition is based, and which we also share in the Volkswagen Group. That is

why we are promoting sound, balanced social development, in Germany and at our other international locations. As part of its strategic partnership, the Volkswagen Group thus helps the German Red Cross to find even more people who are willing to volunteer their time. This goal is central to the partnership, in conjunction with strengthening the Red Cross's rescue service.

NABU has worked with Volkswagen AG for many years and, since the end of 2012, this alliance has been based on a new, expanded cooperation and advisory agreement. NABU is a strategic partner for Volkswagen on the Group's path to becoming the most environmentally friendly automobile manufacturer in the world.

RESEARCH AND DEVELOPMENT

Research and development activities in the Group again concentrated on two areas in 2013: expanding its product portfolio and improving the functionality, quality, safety and environmental compatibility of our products.

Focus of our research and development activities

We plan to cut the average CO<sub>2</sub> emissions of the Volkswagen Group's new European passenger car fleet to 120 grams per kilometer by 2015. We have already succeeded in reducing CO<sub>2</sub> emissions over the past five years by 23 grams of CO<sub>2</sub> per kilometer to 128 grams of CO<sub>2</sub> per kilometer. Since 2012, the CO<sub>2</sub> emissions for vehicle

**CO<sub>2</sub> EMISSIONS OF THE VOLKSWAGEN GROUP'S EUROPEAN (EU 28) NEW PASSENGER CAR FLEET**  
in grams per kilometer

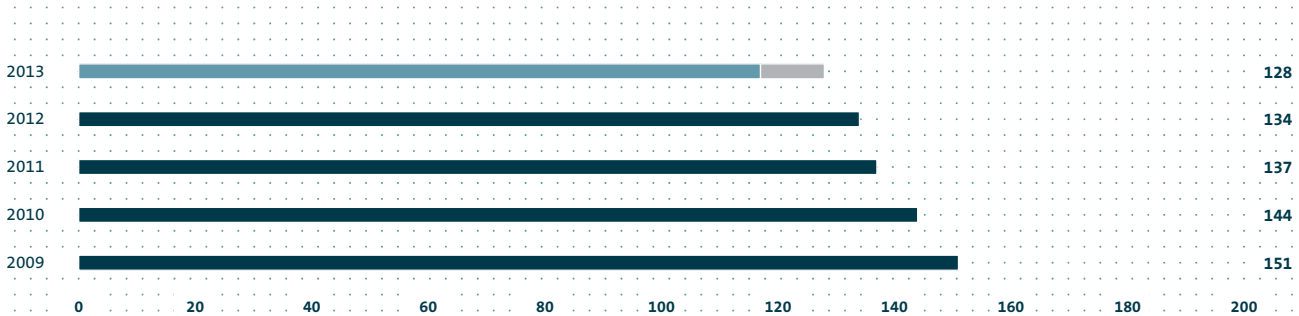

manufacturers' new European passenger car fleets have been regulated by law: for 2013, the emissions of 75% of the new vehicle fleet had to comply with the statutory level of 130 grams of CO<sub>2</sub> per kilometer. The figure for the Volkswagen Group in the reporting period was 117 grams of CO<sub>2</sub> per kilometer. We currently offer a total of 438 model variants (engine-transmission combinations) that emit less than 130 grams of CO<sub>2</sub> per kilometer. For 324 model variants, we are already below the threshold of 120 grams of CO<sub>2</sub> per kilometer. Of these, 54 model variants are even below 100 grams of CO<sub>2</sub> per kilometer (see chart on page 118).

A focus of the Technical Development function in 2013 was on continuing to roll out the Modular Transverse Toolkit. After the first models to be based on the Modular Transverse Toolkit – the Audi A3, the new Golf and the SEAT Leon – were launched in the market in 2012, further derivatives of these models followed during the reporting period, as well as the new ŠKODA Octavia. Other vehicles, such as the Golf Sportsvan that has already been unveiled, will follow.

Automatic driving functions promote predictive driving and offer the potential for increasing efficiency. They make steering safer by reducing the probability of human error, and increase comfort. They also enhance the flow of traffic, thus contributing to the better use of infrastructure. In the near future, a roadworks assistance function will help to reduce or completely avoid accidents around roadworks, for example. We are also conducting research into highly and fully automated driving.

Another focus of our research and development in the past year was on mobile online services. These promote comfort, safety and traffic efficiency and support the vision of cooperative, environmentally friendly and accident-free driving. Volkswagen's Group Research function proved that these technologies are practicable in the grant-assisted project it completed in mid-2013 entitled "Safe and Intelligent Mobility Test Field Germany" (simTD). The first elements we tested were warnings about danger zones and the ends

of traffic jams, intervention by active safety systems and information about traffic light phases.

When it comes to our ambitious target to reduce CO<sub>2</sub> emissions, lightweight construction for large series is becoming increasingly important. The cooperation between Group Research and the production and components departments is accelerating research into lightweight construction and its future production technologies within the Group. Since 2012, we have also been researching economical lightweight construction technologies as part of the public-private partnership "Open Hybrid LabFactory" in collaboration with the Lower Saxony Research Center for Vehicle Technology (NFF) at the Technical University of Braunschweig and other industry partners. We agreed on a contractual framework in 2013 and established the focuses of our research and technology activities. The aim is to have around 200 researchers from industry and science jointly developing hybrid lightweight structures by the end of 2015.

We are constantly extending the use of virtual technologies in our processes, so as to speed up and improve the vehicle development, production, or service process. Smartphones play an increasingly key role in this. The primary focus is on augmented reality technology, in which the real world is recognized and enriched with virtual information. The Audi brand already employs this technology, and Volkswagen is making use of it for the first time in the XL1. Further applications are being developed by Volkswagen's Group Research function. In addition, Volkswagen uses virtual technologies to improve the ergonomics of work sequences in production, for example.

Recognizing new developments in society, technology, politics, the environment and the economy at an early stage is an important basis for innovations and business success. This is why Group Research constantly addresses the latest social and technological trends. It has established interfaces to key global automotive markets to do this. Research offices in China, Japan and the USA

observe technological areas relevant to the automotive industry, conduct cooperative projects with research institutions and local companies, and thus capture new data for the Volkswagen Group.

#### Innovations incorporated into vehicles

The “Automotive INNOVATIONS Awards” are presented every year to vehicle manufacturers by the Center of Automotive Management, an independent organization that conducts empirical research on automobiles and mobility. In fiscal year 2013, the Volkswagen Group won in the “Most Innovative Automotive Company”, “Best Manufacturer: Conventional Drives”, “Best Manufacturer: Alternative Drives” and “Best Manufacturer: Connected Car” categories, once again underscoring its innovative power.

The following are some examples of our innovations in the past fiscal year:

The innovative highlight for the Volkswagen Passenger Cars brand was the XL1, produced in a limited run. With a drag coefficient of 0.189, it is the most aerodynamic series vehicle in the world. Thanks to high tech lightweight construction, it weighs just 795 kg. The XL1 emits only 21 grams of CO<sub>2</sub> per kilometer and consumes just 0.9l of diesel per 100 km with its plug-in hybrid system, consisting of a two-cylinder TDI engine with 35 kW (48 PS), an electric motor with 20 kW and a seven-speed direct shift gearbox (DSG). This also makes it the world’s most economical series automobile with a combustion engine.

The e-up! was launched in 2013 – our first vehicle with a purely electric drive. Its 60 kW (82 PS) electric motor, in combination with an 18.7 kWh lithium-ion battery, gives it a range of up to 160 km. The e-up! can be charged using a 230 volt electric socket, a wall box installed on the customer’s premises, a public AC charge point, or via a DC fast charging station featuring the combined charging system (CCS), which charges the vehicle up to 80% within just 30 minutes.

The Audi brand presented the first notchback model in the compact premium segment with the A3 saloon in the reporting period. Fitted with a 1.4 TFSI engine and the new cylinder-on-demand technology, the vehicle consumes only 4.8l per 100 km and emits 111 g/km of CO<sub>2</sub>. In addition, this new member of the A3 family not only features a low weight thanks to its lightweight construction, but also a large number of high-end infotainment and driver assistance system solutions.

In our new Audi A8, we are using Matrix LED technology for the first time, which sets new standards for headlights in terms of design and technology: the high beam headlights are divided into 25 individual segments whose light-emitting diodes can be separately switched on and off or dimmed depending on the

situation. This allows the system to respond to other vehicles with great precision. The headlights also offer intelligent curve lighting, new-look daytime running lights and indicators with dynamic signaling.

Porsche proved its expertise in hybrid technology in 2013: the Panamera S E-Hybrid is the first plug-in hybrid in the luxury class. With its 416 PS combined maximum output, the E-Hybrid accelerates from 0 to 100 km/h in 5.5 seconds. Its top speed is 270 km/h. In purely electric mode, the Panamera S E-Hybrid travels 36 km, with a top speed of 135 km/h. The vehicle uses an average of just 3.1l of fuel per 100 km, corresponding to CO<sub>2</sub> emissions of 71 grams per kilometer. It also offers an entirely new range of comfort functions, which can also be activated and accessed via a smartphone app. These include the display for the battery’s charge status and range, preheating or precooling the vehicle, and guiding the driver to the parked vehicle.

The Porsche 918 Spyder is ringing in a new era in sports car manufacturing. Designed as a high-performance hybrid from the ground up, it marries the performance of a super sports car with the virtually silent drive of an electric vehicle. Its combined maximum output of 652 kW (887 PS) catapults the hybrid from 0 to 100 km/h in 2.8 seconds. When the vehicle is started, the “E-Power” mode is activated as standard if the battery charge level is sufficient.

Scania Streamline is responsible for the new long-distance models of the G and R ranges, which are optimized for low fuel consumption. Alongside improved aerodynamics and a complete air deflector package, a new version of the Scania Opticruise transmission contributes to this. The economy mode is fully integrated into the Scania Active Prediction predictive cruise control. Combined with the new generation of Euro 6 engines, up to 8% of fuel can thus be saved in long-distance driving.

MAN successfully launched the series production of Euro 6 technology for trucks and coaches. Proven technologies were combined in an intelligent manner and optimally matched with each other. All Euro 6 diesel vehicles feature a comprehensive efficient concept comprising needs-driven exhaust gas recirculation, diesel particulate filters and special exhaust gas after-treatment.

Since June 2013, Audi has been producing a synthetic natural gas – Audi e-gas – and channeling it into the public network. The core element of the newly constructed plant in Lower Saxony is a methanation plant provided by MAN. The 16-meter high unit was designed and manufactured at MAN’s Deggendorf location. Using renewable power, the plant produces climate-neutral fuel that can be both saved and transported via the existing infrastructure.

CO<sub>2</sub> EMISSIONS - STATUS QUO

Number of vehicles

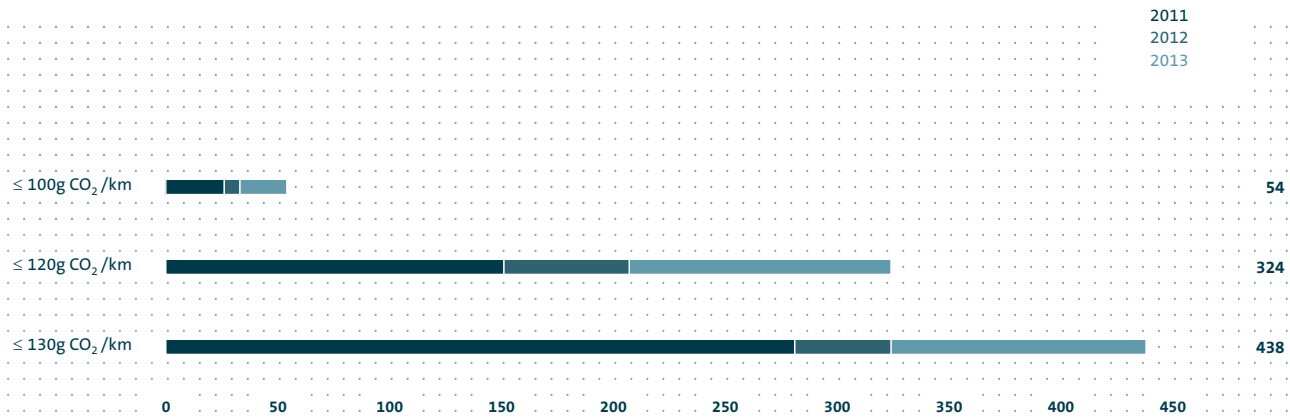

A glimpse into the future – study and concept vehicles

In this section, we describe selected concept vehicles and studies that we presented in 2013 alongside the numerous series vehicles.

The Volkswagen Passenger Cars brand presented the twin up! study at the Tokyo Motor Show. Featuring a plug-in hybrid system with a combined maximum output of 55 kW (75 PS), the four-door's combined consumption is a mere 1.1 l per 100 km. This innovative city specialist shares specific elements of its drive system – diesel engine, electric motor and direct shift gearbox (DSG) – with the world's most economical car, the XL1. The twin up! can travel up to 50 km in purely electric – and thus emission-free – mode.

The Volkswagen Passenger Cars' mid-size SUV study, the CrossBlue, is a masculine six-seater that combines the imposing presence of a SUV with the space of a van. Its innovative plug-in hybrid system with a total output of 225 kW (306 PS) comprises a 140 kW (190 PS) TDI engine, two electric motors (40 kW and 85 kW), a six-speed direct shift gearbox (DSG) and an electric propshaft. The CrossBlue shows how Volkswagen could expand the range of models in the US with a mid-size SUV in the five-meter class.

Audi celebrated the 30th anniversary of the Sport quattro by introducing the Sport quattro concept car, a dynamic coupé study that continues the quattro's long tradition. The Sport quattro concept car boasts a plug-in hybrid drive with a combined maximum output of 515 kW (700 PS). The 110 kW electric motor and twin-turbocharged 412 kW (560 PS) V8 engine propel the lightweight sports car from 0 to 100 km/h in just 3.7 seconds. Its rectangular twin headlights use pioneering Matrix LED technology.

The Audi nanuk quattro concept car, a crossover study, was developed in close cooperation with the designers from Italdesign Giugiaro, and marries the dynamism of a high-performance sports car with Audi's quattro expertise on the street, on the race track and off-road. The sports car for young and old is powered by a 400 kW (544 PS) V10 TDI engine.

Driven by its passion for innovation and alternative solutions, Lamborghini commemorated its 50th anniversary with the unveiling of the Egoista: powered by a 440 kW (600 PS) V10 engine, this supercar is a sports car of superlatives that wows with its masculine design. The interior of this one-off is extremely rational and is made for one person only.

Leveraging synergies increases efficiency

A number of studies during the reporting period proved that Volkswagen AG is investing more than any other company in research and development. In order to make even better use of these resources in the future to contribute to the Company's success, additional synergies are being leveraged by way of cross-brand cooperation to develop technologies. To ensure this, a Group Board of Management Technology Committee was formed; it defines the efficient development and implementation of core technologies in the Group that make us competitive in the long term. This relates in particular to strategic key technologies that a brand on its own could only finance with difficulty. In addition, the individual brands use our modular toolkits, which ensure that we can benefit from the synergy effects that exist both between models in one series and across all series and brands.

#### Pooling strengths with strategic alliances

The Volkswagen Group is systematically pressing ahead with research into and the ongoing development of high-voltage battery systems for electric and plug-in hybrid drives in cooperation with expert battery manufacturers. We continued and intensified these cooperative projects in 2013. VOLKSWAGEN VARTA Microbattery Forschungsgesellschaft mbH & Co. KG, which we formed in 2010 with VARTA Microbattery GmbH in Ellwangen, successfully continued its work and achieved important research results in the field of electric vehicle batteries in the reporting period.

Our collaborative projects with the Budapest University of Technology and Economics and the Lawrence Berkeley National Lab – as well as with other national and international partners – are also in the area of battery research.

We continued our cooperation with Daimler AG in 2013 to produce the Crafter; this arrangement will continue until 2016.

#### Integrating external R&D expertise

In addition to our own internal resources, the expertise of our suppliers is extremely important in our development process; it will help us to systematically advance our new model rollout in the coming years. The early-stage, close collaboration between our internal and external resources guarantees that we can successfully complete projects with the quality we expect in reduced development times. We draw on external expertise particularly in creative processes and in the area of virtual technologies and megatrends.

We also use external capacity for support services, downstream processes such as series management, and activities that are not customer-facing but generate improvements. We are systematically

expanding our cooperation with subsequent series suppliers in order to be able to tap their expertise in the development phase of modules and components.

#### Numerous patents filed

In the reporting period, we filed 5,948 patent applications for employee inventions, around half of them in Germany. This large number and the technical quality of the ideas submitted in 2013 demonstrates once again the innovative power of our top team. The patents filed related mainly to innovations in the technology areas of modular infotainment, driver assistance systems, alternative drive technology and intelligent lightweight construction.

#### Key R&D figures

The total research and development spend in the Automotive Division for fiscal year 2013 increased by 23.4% year-on-year. Alongside new models, the main focus was on the electrification of our vehicle portfolio and increasing the efficiency of our range of engines; the proportion accounted for by alternative drive technologies again increased. The capitalization ratio rose to 34.2% (27.5%). Research and development costs recognized in the income statement in accordance with IFRSs increased to €10.2 billion (€8.9 billion). This meant that their ratio to sales revenue in the Automotive Division amounted to 5.8% (5.1%).

On December 31, 2013, the Research and Development function – including the equity-accounted joint venture companies in China – employed 43,756 people Group-wide (+4.0%), corresponding to 7.6% of the total headcount.

## RESEARCH AND DEVELOPMENT COSTS IN THE AUTOMOTIVE DIVISION

€ million	2013	2012	2011	2010	2009
Total research and development costs	11,743	9,515	7,203	6,257	5,790
of which capitalized development costs	4,021	2,615	1,666	1,667	1,947
Capitalization ratio in %	34.2	27.5	23.1	26.6	33.6
Amortization of capitalized development costs	2,464	1,951	1,697	2,276	1,586
<b>Research and development costs recognized in the income statement</b>	<b>10,186</b>	<b>8,851</b>	<b>7,234</b>	<b>6,866</b>	<b>5,429</b>

## PROCUREMENT

Procurement focused its work in the reporting period on safeguarding new vehicle start-ups, developing new procurement markets and ensuring continuity of supply to production.

### Procurement strategy

Procurement makes an important contribution to the implementation of the Group Strategy 2018 with its procurement strategy. It continues to pursue four goals derived from the Group strategy: first, to provide market-centric premium quality and innovations at competitive prices; second, to meet cost targets and ensure the profitability of our products over their entire lifecycle; third, to safeguard our global volume growth through the permanent availability and consistently high quality of procured components; and fourth, to continue to raise employee satisfaction and the attractiveness of the procurement function.

We have assigned action areas to each of these goals. Each action area has concrete programs comprising precisely defined measures and responsibilities. These strategic elements are standardized and implemented throughout the Group, which enables us to take advantage of opportunities across all brands and all regions, pool strengths and minimize weaknesses and risks at the same time.

### Procurement's process optimization program

Continuous process optimization has become a core component of the global procurement organization. In 2013, our experts also continued work on improving and standardizing a large number of workflows worldwide as part of our process optimization program, in particular at the interface with processes in other functions. This enables us to reduce frictional losses and create synergies. For example, we improved requirements planning for equipment variants, enabling capacity for procured components to be planned significantly more precisely.

In 2013, we also began benchmarking the indicators, comparing them across all of the procurement organizations. This enables us to more quickly recognize and take advantage of best practice processes and areas for improvement.

### Supply situation for procured components and raw materials

The supply situation in 2013 was dominated by the continued growth of vehicle sales in China, the steady increase in demand for vehicles based on the Modular Transverse Toolkit (MQB) and the ongoing trend toward vehicles with high-quality equipment levels. This in turn drove up our need for procured components. However, in cooperation with our suppliers, we made available the capacities needed to supply the component and vehicle plants.

Unplanned events in 2013, for example fires in China, also led to production shortfalls at our suppliers. Together with suppliers, our established cross-business area task force helped to guarantee the security of supplies at all times.

We also added additional suppliers to our INCA integrated capacity management system, which we use to safeguard our supply. 4,100 suppliers already manage their capacities in the Group online, which gives them an insight into the requirements forecasts for their parts for a planning horizon of up to 24 months.

In 2013, the global economy continued to grow, albeit at a slower pace year-on-year. The prices for most input and raw materials fell slightly on the spot markets. This was attributable to the sluggish demand from the industrialized nations and the relatively moderate growth in China. Crude oil prices remained volatile and reacted strongly to speculation and political uncertainty.

Economic effects also impacted prices for iron ore, coking coal and rare earths. The prices for these input materials are at a low level compared with the record highs in 2011; compared with 2012, the 2013 prices were similarly volatile and at a comparable level. China did not come close to exhausting its 2013 export quotas for rare earths set by the government; nevertheless, there were no supply shortages for components containing rare earths.

### Procured component and supplier management assure quality within the supply process

Procured components management is firmly established in the Volkswagen Group's global procurement organizations in the brands and regions. Tool and process experts support new vehicle start-ups around the world using Group-wide standards. As the automotive industry becomes more complex, we have helped suppliers secure parts for our series production.

Enhancing procured components management in the engines and transmissions areas is a particular focus for implementing the Group-wide growth strategy. Procured component management will strengthen its activities in this action area in the future.

In addition, the "Quality in Growth" program is focused on safeguarding start-ups in the context of internationalization and on managing the subcontractor structure. We hold cross-business area discussions with suppliers on best practices and lessons learned.

Other tools for preventive safeguarding of vehicle start-ups include simulated series production at the suppliers as part of preliminary series production and a multi-step performance test across all business areas. This enables us to identify supplier problems related to volume and quality in good time and to counteract any potential risks.



#### Developing new procurement markets

In order to achieve the cost targets derived from the Group Strategy 2018, we are developing affordable procurement markets under the C3 Sourcing (Cost-Competitive Country Sourcing) program.

In the reporting period, we took additional measures to integrate these activities in the markets. These include common sourcing – bundling volumes between different procurement markets. These common market-wide requests for the same or similar components will generate synergies for the participating locations and projects. This type of transregional awarding strategy is a win-win situation for Volkswagen and its business partners, as the latter can thus offer more affordable prices because of higher volumes and can become established competitors in new regions.

One example of targeted volume bundling and integration with local procurement markets and structures is our common sourcing activities in China: we achieved our cost targets by bundling request volumes. At the same time, we integrated 700 new suppliers into our systems environment. In the future, they will participate in global tenders and thus have the opportunity to export their products outside local markets.

#### Sustainability in supplier relationships

Since 2006, procurement has followed the requirements of the “sustainability in supplier relationships” concept, supporting our goal to become the most sustainable automobile company in the

world by 2018. This concept helps secure the global volume flows as it avoids situations in which suppliers fail to deliver.

The “requirements for sustainability in relations with business partners” are a key component of the concept we use to expect and promote sustainability efforts from our suppliers. This takes into account both social and environmental standards.

In the reporting period, we again deepened our relationships with suppliers in order to supportively monitor sustainability requirements and to minimize sustainability risk: we surveyed them in detail on the current status of their implementation of our requirements and remedied any deficits together. We also provided more in-depth training in 2013 via our Internet-based training module.

Consistently implementing the “sustainability in supplier relationships” concept as well as providing intensive training for our own employees enables us to systematically reduce both procurement-relevant sustainability and supplier risk and to meet customer and capital market requirements.

#### Purchasing volume

The Volkswagen Group’s purchasing volume mainly comprises production materials, services and investments. In the reporting period – including the Chinese joint venture companies – it saw an increase of 4.9% to €135.0 billion. Suppliers in Germany account for a share of 37.3% (38.8%).

#### PURCHASING VOLUME BY BRAND AND MARKET

€ billion	2013	2012	%
Volkswagen Passenger Cars	79.0	77.0	+2.5
Audi <sup>1</sup>	23.6	22.7	+4.3
ŠKODA	6.5	6.6	-1.5
SEAT	3.9	3.7	+6.7
Bentley	0.7	0.6	+9.7
Porsche <sup>2</sup>	3.7	1.4	x
Volkswagen Commercial Vehicles	2.4	2.4	+1.3
Scania	6.4	5.2	+22.3
MAN	8.8	9.1	-3.4
<b>Volkswagen Group</b>	<b>135.0</b>	<b>128.7</b>	<b>+4.9</b>
Europe/Remaining markets	87.9	88.1	-0.3
North America	6.3	6.2	+2.3
South America	8.9	8.0	+12.0
Asia-Pacific	31.9	26.4	+20.6

1 Audi includes Lamborghini and Ducati (from August 2012).

2 Porsche from August 2012.

# Volkswagen is electrifying!

Moving boldly into the age of e-mobility

The automobile industry is changing – steadily, step by step, starting out on the road to e-mobility. This change is not a radical break with the past – rather it will take place gradually over the next few decades. Several trends and factors supporting this process are evident: first and foremost, climate change and the target agreed by governments worldwide to reduce CO<sub>2</sub> emissions by some 90% by the year 2050. A further factor is the fact that supplies of primary fossil materials are finite and are estimated to last in sufficient quantities for only another 40 to 60 years. In addition, greater urbanization is creating noise and air pollution in megacities, so that governments have had to introduce emission controls.

The Volkswagen Group has been working on e-mobility since the 1970s. But for a long time, neither the technology nor the market was ready for large-scale series development. But it's a different story today – interest in e-mobility has grown substantially, thanks to a combination of steadily improving battery technology and falling prices for battery cells, national support programs and higher expectations of sustainable vehicle concepts in the marketplace. Against this backdrop, the Volkswagen Group anticipates that by 2020 electrified vehicles will make up around 3% of total vehicle production. The market share in cities will be much greater.

The Volkswagen Passenger Cars brand launched series production of the Touareg Hybrid in June 2010, the first all-terrain hybrid in the European SUV segment. It was followed by hybrid versions of the Jetta, Audi Q5, Audi A6, Audi A8, Porsche Cayenne and Porsche Panamera. MAN is using hybrid technology in its Lion's City Hybrid bus. Moreover, the Company presented the first prototype of the Golf with a purely electric drive – again in June 2010. In 2011 and 2012, the Volkswagen Group brands carried out extensive fleet trials with electric and plug-in hybrid vehicles in Europe, China and the USA to make sure that every aspect relating to user requirements, suitability for everyday driving and technology had been tested in advance of series production. We started our campaign to move boldly into the era of e-mobility in 2013 with the launch of the e-up!, the first pure-play electric vehicle on the market. The e-Golf will also be available in spring 2014.

In its drive electrification activities, the Volkswagen Group is focusing particularly on the plug-in hybrid concept. This combines the benefits of two technologies and hence offers a majority of customers exactly what they are looking for: an attractive electric-drive unit for day-to-day urban use, unlimited range thanks to its combustion engine, no restrictions on speed or its ability to

climb hills or pull trailer loads and substantial potential for reducing CO<sub>2</sub> emissions.

In 2013, we launched our first plug-in hybrid-drive vehicles onto the market – the Porsche Panamera S E-Hybrid, the Porsche 918 Spyder and the flagship of Volkswagen's electric drive technology, the limited-run XL1. The Golf and the Audi A3 will be the first plug-in hybrid models launched in 2014 to be based on the Modular Transverse Toolkit (MQB).

## DRIVE DIVERSITY IN THE MQB

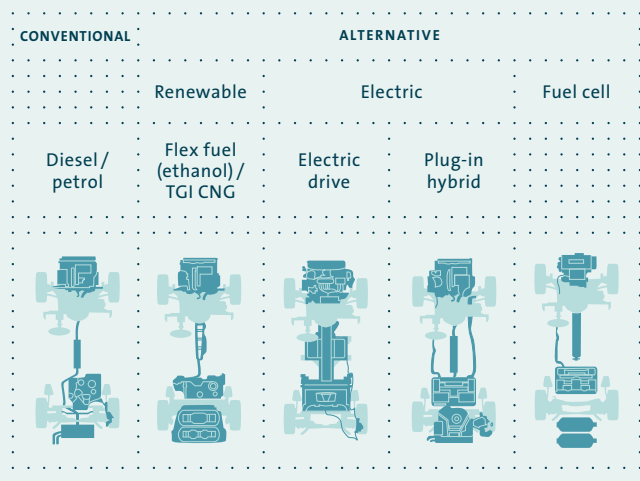

The integration of electric traction into the modular toolkit strategy, especially the MQB, is absolutely crucial for the Group and at the same time constitutes a major competitive advantage. The MQB enables us to manufacture a whole range of electric and hybrid vehicles, including country-specific equipment, cost-efficiently in series production for all our markets. For example, all drive types can be incorporated into a Golf – from conventional drives and drives running on renewable energy, down to electric drives and, in the future, fuel cell drives as well – all produced bumper to bumper on the same assembly line. As many parts as possible will be taken over from the toolkit. The MQB also

enables us to implement the same concept in other vehicle classes based on the MQB, e.g. the Passat. Lightweight construction is also becoming more important here.

Alongside design, the drive is the most important factor shaping the customer-vehicle relationship. It was important for us right from the beginning to make sure that alternative drives also had their own dedicated development and in-house manufacturing teams. That is why we worked intensively on developing electric motors and battery systems and built up the necessary manufacturing skills at our plants in Kassel (electric drives) and Braunschweig (battery systems). Over two-thirds of the Automotive Division's €84.2 billion investment program between 2014 and 2018 is earmarked for developing more efficient vehicles, drives and technologies, as well as environmentally friendly production processes. The Group has already hired additional skilled workers and experts to strengthen its expertise in the area of electric traction. In 2014, the new e-mobility campus will open within the research and development site at the Wolfsburg headquarters. This campus is where the Group will concentrate its expertise in the field of electric traction. A total of some 1,100 people will undertake research and work on this technology there.

#### OUR E-MOBILITY STRATEGY

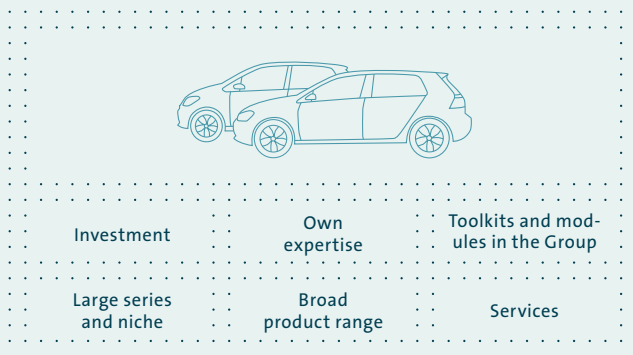

There are several hurdles still to be overcome on the road towards more widespread take-up of e-mobility. Despite considerable advances in the past few years, the battery is still by far the biggest cost factor in today's electric vehicles. However, new challenges and opportunities arise not only out of vehicle development itself, but also from integrating vehicles into their environment. The e-mobility system as a whole incorporates the idea that the vehicles of the future will be integrated into intelligent networks and will be able to communicate with other vehicles, buildings, or passers-by. For example, information about the level of battery charge or the charging time required can be accessed via a smartphone, or a vehicle can be located, reserved and paid for as part of a carsharing model. Other questions arise regarding the charging strategy.

One initial success has been standardizing charging plugs to the CCS (Combined Charging System) standard. These plugs can be used to charge electric cars either via a socket in a fast-charging station or via a wall box (a special socket, e.g. for garages) installed at home. Volkswagen is supporting the use and further development of renewable energy sources such as wind or water power in order to offer completely emission-free mobility from a single source across the whole life cycle of the vehicle, and not just the

#### THE E-MOBILITY CHALLENGE

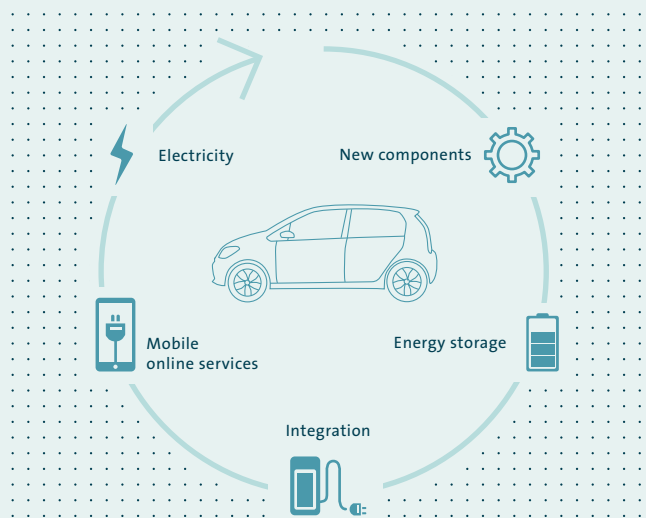

electric vehicle itself. Many of these issues also demand substantial commitment from politicians, local authorities and energy utilities. The Volkswagen Group plans to offer its customers new services and business models through intelligent networking across the automotive, energy supply and telecommunications sectors that will make switching over to the new technologies easier for them.

Volkswagen's electric vehicles are dynamic, highly emotional automobiles that are fun to drive – they express the driver's modern attitude to life and appreciation of advanced technology. Our aim is to offer safe, affordable electric vehicles suitable for everyday use, to almost all customer groups.

**FURTHER INFORMATION ON THIS TOPIC**  
[www.volkswagen.com/emobility](http://www.volkswagen.com/emobility)

## PRODUCTION

In fiscal year 2013, the Volkswagen Group again expanded its production network and increased its global production volume by 5.1% to 9.7 million vehicles. Productivity improved by 5.7% year-on-year despite difficult conditions in many markets. In the European market, declining volumes impacted productivity trends for some vehicle segments. However, this was more than offset by the increasing unit sales in China and the Group's systematic implementation of its production system.

### "Production 2018" strategy

The goal of our "Production 2018" strategy, which the Production function pursues in all Group brands and all regions, is to build the world's most powerful and most fascinating automotive production system. The core objectives comprise enthusiastic customers, a higher earnings contribution, a global production network as well as a high level of attractiveness for employees. These objectives were assigned 13 challenges. Measures have been formulated for each of these challenges to improve production processes and connect them across all brands and all regions worldwide. This will ensure that our strategy is implemented sustainably and that our organization is prepared to meet future requirements.

### Production locations

The Volkswagen Group's global production network grew in 2013 from 99 to 106 locations. At the end of the reporting period, it consisted of 61 passenger car, commercial vehicle and motorcycle factories as well as 45 powertrain and component plants.

The Group's 100th location opened in Silao, Mexico, back in spring 2013; this engine plant is the fourth production site in North America. This was followed by the MAN commercial vehicle plant in St. Petersburg and then by a total three vehicle plants in China – in Urumqi, Foshan and Ningbo. In addition, operations also began at a new engine plant in Changchun and, at the end of the year, a production location in Foshan for axles and struts, in order to safeguard the local supply of components to Chinese plants.

With 68 vehicle and component locations, Europe remains at the heart of our production network; 28 of these plants are located in Germany alone. The Asia-Pacific region is increasingly important, with 22 locations, 17 of which are in China. North America now has four production sites; the number of production sites in South America (nine sites) and Africa (three sites) remained unchanged in the reporting period.

Construction of Audi's first automobile factory in North America has been underway since May 2013 in San José Chiapa, Mexico. The highly efficient production facility, with an annual capacity of 150,000 vehicles, is expected to start production from mid-2016; Audi's next generation of the Q5 will be produced here.

Starting in 2015, Audi will begin production for the local market, laying the foundation for further growth in South America: the new Audi A3 saloon and the Audi Q3 will be produced in Volkswagen do Brasil's Curitiba plant. Volkswagen do Brasil is also expanding this plant to accommodate production of the new Golf, thus bringing our most advanced production technology, the Modular Transverse Toolkit (MQB), to Brazil starting in 2015.

Construction for a new vehicle plant began in May 2013 in Changsha, China, where an end-to-end automobile production facility with an annual capacity of 300,000 vehicles is being built for the Shanghai-Volkswagen joint venture by 2015 in the Southern central region of China.

We expanded our production partnerships as well as our production network in the reporting period. In Russia for example, our partner GAZ has been producing the Jetta at its Nizhny Novgorod site since the first half of 2013, and began production of the ŠKODA Octavia shortly thereafter.

The ASEAN region plays an important role in our growth strategy. It has high potential demand and is extremely diverse, for example in terms of its culture, income, vehicle requirements and customs and tax legislation. This is why we developed country-specific, long-term production concepts to support our local sales activities as part of our strategy for the largest markets in this region.

Our involvement in Indonesia started with local vehicle assembly in 2009 and has developed very positively in recent years. Because of the great success seen in this market, we opened a new assembly facility with greater capacity in Cikampek together with our local partner Indomobil in December 2013. In addition, we expanded the product portfolio in the last year to include the Tiguan and the new Golf. This brings the number of models assembled there to six for the Volkswagen Passenger Cars, Audi and Volkswagen Commercial Vehicles brands.

In Malaysia, we are currently expanding our local production in cooperation with our local partner DRB-HICOM. A new CKD production facility opened in 2013 at its site where up to 40,000 vehicles a year can be assembled. Currently, the Polo, Jetta and Passat models are being produced there.

We are also examining potential new production locations in the rest of the ASEAN region in order to achieve our ambitious unit sales targets.

### New start-ups and production milestones

The Volkswagen Group implemented 27 new production start-ups in 2013, ten of which were new or successor products.

A highlight for the Volkswagen Passenger Cars brand was the start of production of the Golf estate in May 2013 at the Zwickau location. The start of manufacturing in Bratislava of the first fully electronic series vehicle – the e-up! – in July marked another mile-

VEHICLE PRODUCTION LOCATIONS OF THE VOLKSWAGEN GROUP

Share of total production 2013 in percent

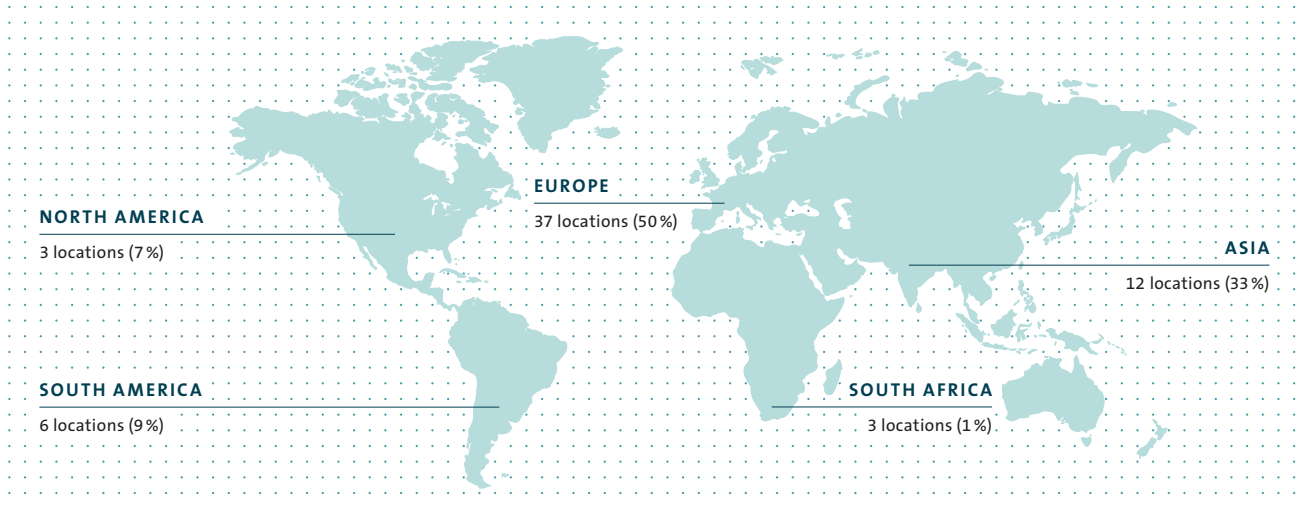

stone. Audi kicked off the series production of the Audi A3 saloon in May at its expanded production facility in Győr, Hungary. The ŠKODA brand rolled out production of the seventh generation of the Octavia Combi in Mladá Boleslav in March and expanded its product range in August to include the Rapid Spaceback. The SEAT brand rounded off its Leon family in Martorell, Spain, in September with the Leon ST. Bentley began production of the second generation of the Flying Spur in Crewe in the United Kingdom.

We began production of the new Golf in China in July, the first time that the new generation of the bestselling model is being produced outside Europe; this also marked the start of operations at our new Foshan site.

The Group is continuing its success story in the South American small car segment in Taubaté in Brazil, where it has been producing the up! since the fourth quarter. Finally, at the end of 2013, production of the fifth series from Porsche started in Leipzig: the Macan.

The Volkswagen Group again celebrated anniversaries in 2013: in February, ŠKODA produced the 15 millionth vehicle since becoming a member of the Group. The eight millionth Gol was produced in March in Brazil. In June, the Wolfsburg plant reached the 30 million milestone for Golf models manufactured worldwide. The 10 millionth vehicle rolled off the production line in August in Puebla, Mexico. In November, the 25 millionth engine in the history of Audi Hungaria left the production facilities in Győr.

Flexibility in production

We design our production locations to be as flexible as possible. We adapt existing vehicle plants for multiple brands, converting them into multiple-brand plants. This allows us to react more easily to

changing market requirements, exploit cross-brand synergies, improve processes and reduce investments.

One example is the new location that opened in Foshan, China, in September 2013: this extremely flexible vehicle plant is currently producing the Audi A3 saloon, the Audi A3 Sportback and the new Golf. If demand for one of these models rises, the production facilities permit us to increase the production volume of that model and lower that of another.

Our customers increasingly want more customized vehicles. A growing offering of vehicle and powertrain derivatives enables us to cater to this wish. Thanks to the modular toolkits developed by the Group, we can produce a wide variety of vehicle and drive concepts with a minimum of effort using a uniform vehicle architecture. Using modular toolkits across all brands – accompanied by the resulting standardization and synergies in the production process – allows us to efficiently produce different models on a single production line.

We are also standardizing operating equipment, systems, production areas and even entire factories. This makes us significantly more flexible when we are adapting our plants to accommodate multiple brands, accelerating and safeguarding new vehicle start-ups.

The Group's production system

Our Group production system was introduced in 2007 and involves employees in optimizing corporate processes. Since then, we have systematically applied its principles and methods to all brands and areas in the Group, anchoring it in each of them. We are successfully increasing quality, productivity, ergonomics, leadership and teamwork by using a continuous improvement process

(CIP) in the Company. Additional process and organizational improvements are intended to make Volkswagen number one in the automotive industry by 2018 in terms of customer satisfaction, its attractiveness as an employer, profitability and growth.

The introduction of the Group's production system was an important step toward to creating a value-driven company with coordinated processes. Throughout the world, we are implementing these principles and methods at the brand and regional locations and are continuing to systematically enhance the production system in order to safeguard what we have accomplished to date for the long term.

Our ambitious growth objectives also create a challenge for logistics. The "Neues Logistik Konzept" (NLK – New Logistics Concept) manages the difficulties arising from the increasing volume of materials and the widening variety of components. We are using this to make our material and information flows even more efficient throughout the Group. Initially, our focus was on making significant improvements in providing materials to our assembly lines. In the future, we will turn our attention more strongly towards the upstream transportation and logistics processes between our locations and our suppliers, where potential synergies are high. These mainly result from smaller inventories, greater transparency as well as more stable processes and higher quality information.

#### Efficient production

To achieve our goal of becoming the world's most sustainable automobile manufacturer, we have begun to redesign production processes at all locations along end-to-end ecological lines. Our aim is to align economics with ecology. We demonstrably cut costs and conserve the environment by using resources efficiently and cutting emissions. For example, we recorded CO<sub>2</sub> savings of over 229,000 t in 2013 by implementing more than 1,260 measures to improve energy and environmental processes in the production of passenger cars and light commercial vehicles in the course of a system-based exchange of best practices. At the same time, there is also an economic benefit as this corresponds to cost savings of more than €28 million each year.

The Group's brands are implementing the Volkswagen Group's ecological reorganization by means of their own cross-disciplinary strategies. For example, the Volkswagen Passenger Cars and Volkswagen Commercial Vehicles brands are bundling all ecological measures related to efficient use of resources and lower emissions in production in their holistic "Think Blue. Factory." program, which was launched in 2011 under the motto "More sustainability – less environmental impact". When we systematically share knowledge between the locations and across trades, we benefit from our employees' collective expertise. "Think Blue. Factory." is part of "Think Blue.", the Volkswagen brand's holistic initiative promoting ecological sustainability.

Other brands have launched initiatives to reveal potential, develop strategies and solutions, and take action in order to meet the Volkswagen Group's sustainability goals. Examples include the ŠKODA brand's "GreenFuture" initiative, the SEAT brand's "ECOMOTIVE Factory" initiative and the MAN brand's climate strategy.

Here are a few examples of ecological activities that were implemented successfully in the reporting period:

In order to exploit existing energy-saving potential, an energy value stream analysis pilot project was implemented in the paint shop and body shell production facility at the Bratislava plant. The first step was to determine how much energy is needed for production and where there are potential savings so that consumption can be reduced in the next step. Our aim with this measure is to target energy savings of 49,000 MWh and CO<sub>2</sub> savings of 9,800 t. At the same time, these savings will cut over €700,000 in costs each year.

The location of the Emden plant is being leveraged to save energy by using geothermal energy. When the body shell production building was built, geothermal piles were set into the ground. These piles harness the coldness in the ground to cool equipment during the production process. This measure offers savings of 12,000 MWh of energy and 25,000 m<sup>3</sup> of water and also cuts our costs by €70,000 a year compared with a cooling tower that would otherwise be needed.

The Pamplona plant can reduce or avoid waste thanks to its successful waste strategy. It prepares a list of the types of waste that can be reused. In addition, it identifies which processes create waste so that new process workflows can be developed to reduce or reuse waste. Already, 380 t of paint sludge have been cut, saving us €60,000 a year. The structured approach enshrined in this waste strategy is also being rolled out at other Volkswagen Passenger Cars and Commercial Vehicles plants, reducing the amount of waste they produce.

The Braunschweig plant can save 34,380 m<sup>3</sup> of water by using conductivity-based spray water metering in its paintshops. This also makes a difference in costs: this optimization measure saves approximately €232,000 each year.

In 2013, SEAT completed the third and final construction phase of its "SEAT al sol" solar rooftop park at its Martorell plant in Spain. A total of 53,000 solar panels cover an area of 276,000 m<sup>2</sup> and were installed on the roofs of production facilities and delivery areas. With an annual capacity of 15,000 MWh of electricity, this helps SEAT cut its CO<sub>2</sub> emissions by 7,000 t/year.

As the Volkswagen Group's ecological restructuring takes place, it is essential to get employees even more involved. For this reason, the training center in Chemnitz that is open to all Group employees developed an energy training program in 2013 that reproduces a realistic production environment and simulates different energy

situations. The aim is to teach employees basic skills for saving energy and to enable them to identify energy waste in their immediate working environment.

#### SALES AND MARKETING

The Volkswagen Group's unique product portfolio comprises twelve successful brands that excite millions of customers worldwide, year in and year out. In 2013, we systematically reinforced the distinct and individual image of each brand and optimized their market positioning.

##### Brand diversity in the Volkswagen Group

The "Volkswagen – Das Auto." slogan unites the three core messages that distinguish the Volkswagen Passenger Cars brand: its products are innovative, offer enduring value and are responsible. Customers worldwide associate quality, reliability and German engineering skill with Volkswagen Passenger Cars. Global brand management focuses on the wishes and preferences of customers, today and in the future. They are the starting point for developing innovations that are driven by demand while remaining affordable. This is our competitive advantage: based on this, the Volkswagen Passenger Cars brand aims to become the most innovative volume manufacturer with the best quality in each class in the medium to long term.

In the premium segment, Audi has become one of the strongest car brands worldwide under the slogan of "Vorsprung durch Technik". Its objective is to become the market leader in this segment. To do this, the Audi brand relies heavily on its progressive, high-quality and sporty image. The numerous honors and awards it has received attest to the brand's strategy of innovative engineering solutions and an emotional design language.

With its "Simply Clever" slogan, ŠKODA has become one of the fastest emerging brands, particularly in Europe and China. The brand image is defined by a compelling value proposition and an attractive design, coupled with intelligent ideas for the use of space that are technically simple but offer sophisticated, practical details.

The Spanish SEAT brand is aiming for stronger growth, particularly in Europe, by sharpening its brand profile and focusing on its distinctive brand values: it is dynamic, young and design-oriented. The brand claim – "Enjoyneering" – characterizes the brand's passionate perfectionism and emotional technology leadership.

Sports car manufacturer Porsche's brand values are a combination of opposites: exclusivity and acceptance, tradition and innovation, performance and suitability for daily use, design and functionality. Porsche's philosophy is "to achieve maximum output from minimum input" while adhering to high quality standards.

Exclusivity, power and elegance – these are the qualities demonstrated by our Bentley, Bugatti and Lamborghini brands in the luxury vehicle segments. They round off the Volkswagen Group's brand diversity in the passenger cars segment.

Volkswagen Commercial Vehicles stands for superior mobility with its three core values – reliability, economy and partnership. The brand offers a range of different transportation solutions at the highest levels of engineering for different customer groups. The vehicles are tailored to meet the individual transportation needs of customers in retail and craft businesses, as well as civil authorities and service providers. Private customers value the brand's family-friendly MPVs and recreational motor homes.

The Swedish Scania brand follows the core values of "customer first", "respect for the individual" and "quality". This successful company has been manufacturing high-performance trucks and buses featuring extremely innovative technology for over 100 years. The brand offers its customers efficient transport solutions backed by service offerings and financial services.

The core values of the MAN brand are reliability, innovation, dynamic strength and openness. At the same time, these values are key success factors for MAN, one of the leading European manufacturers of commercial vehicles, engines and mechanical engineering equipment. As well as trucks and buses, the company manufactures diesel engines, turbomachinery, turnkey power plants and special gear units.

Ducati is one of the most famous manufacturers of premium motorcycles. Its emotionally charged products thrill the Italian brand's customers with their premium quality craftsmanship, uncompromising performance and challenging dynamics.

##### Think Blue.

"Think Blue." is the Volkswagen Passenger Cars brand's ecological sustainability policy. It is Volkswagen's answer to, among other things, the question of how individual mobility can be reconciled with sustainable practices. "Think Blue." is contributing to the Volkswagen Group's objective of being the most sustainable automobile manufacturer in the world by 2018.

In addition to the international "Think Blue. Factory." program, which aims to conserve resources and lower emissions in the vehicle and components plants, another example of the "Think Blue." range of activities is an initiative at Volkswagen dealers in Germany. Starting in 2014, all partner operations will be provided with advice on eco-efficiency that will suggest concrete measures for running an environmentally friendly dealership.

The Volkswagen Passenger Cars brand was also a partner of the 2013 One Young World Summit in Johannesburg. Around 1,300 young people from 190 countries discussed topics such as sustainable development with experts and celebrities. Twenty-five young international Volkswagen Passenger Cars brand employees provided information on "Think Blue." at the summit, participating in discussions so as to identify trends and challenges for the Company to address.

#### Customer satisfaction and customer loyalty

The Volkswagen Group's sales activities focus consistently on making our customers satisfied customers – this is the top priority for us. We further increased the satisfaction of our vehicle buyers, after-sales customers and dealership partners with the measures and process improvements we implemented in 2013.

The Group brands regularly measure the satisfaction of their customers, focusing on products and services and derive measures from the survey results to improve customer satisfaction even further.

Measured in terms of customer satisfaction with their products, the Audi and Porsche brands are among the leaders in the core European markets in comparison to other Group brands and their competitors. The other brands in the Group also score higher than competing brands.

Customers are loyal to our brands and trust them when they are satisfied with our products and services. The extent of this trust is impressively illustrated by our loyalty figures, which we measure on a regular basis. The Volkswagen Passenger Cars brand, for example, has maintained a high level of customer loyalty in its core European markets for several years in a row. The loyalty of Audi, Porsche and ŠKODA customers has likewise kept these brands in the upper rankings in a competitive comparison for a number of years.

#### Structure of Group sales

The Volkswagen Group's multibrand structure helps promote the independence of our brands. Nevertheless, we use cross-brand sales activities to increase sales volumes and market share and increase sales efficiency, while cutting costs and lifting earnings contributions.

In the reporting period, we strengthened dealer profitability in particular. This was achieved firstly with cost-cutting programs and secondly by expanding the business volume for each dealer. Our distribution network strategy, which calls for us to work with strong partners and leverage all business fields, as well as the difficult economic situation in some countries led to the distribution network being restructured. The focus is on a close working relationship with dealers and their profitability. We use Group companies to manage our wholesale business in over 20 markets. A central department makes sales activities more transparent and more profitable, as well as creating synergies between the different brands. Wholesale companies can learn quickly and efficiently from the best practices adopted by individual firms. The central department is instrumental in helping us achieve the goals laid down in the Group's Strategy 2018.

Following the integration of Porsche Holding Salzburg, we reorganized trading activities in the Volkswagen Group so as to be able to take full advantage of this company's specific skills. The majority of the Group's proprietary trading activities are now

managed by Porsche Holding Salzburg. The company is a key element for strengthening our position in the emerging markets; for example, it took over the function of importer in Chile in March 2013. We also systematically and rapidly expanded their presence in China in the reporting period.

#### Fleet customer business further expanded

Our relationships with fleet customers are often of a long-term nature. This customer group guarantees more stable vehicle sales than in the private customer segment in a volatile environment. The Volkswagen Group has an established base of business fleet customers in Germany and the rest of Europe in particular. Our extensive product offering enables us to satisfy custom mobility needs from a single source. This allowed us to largely defend our well established position in Europe in 2013.

#### The e-mobility challenge for Group sales

The Volkswagen Group's e-mobility strategy covers the development of customer-centric products and business models to complement its range of electric vehicles.

In the reporting period, we entered into partnerships with green energy utilities such as "LichtBlick" and installation service providers for the charging infrastructure, including Bosch. These partners will help us provide our customers with comprehensive vehicle-related offerings. When selecting products and partners, we took great care to preserve the identities of our brands while, at the same time, generating maximum synergies for the Group.

We also provided additional sales and after-sales services to our electric vehicle customers.

#### Used car business

The used car business is the fourth key source of income in our dealer organization after the new car, services and parts businesses. We ensure its profitability by providing efficient processes and systems, highly qualified employees as well as clear guidelines and management tools.

We focus on professional used cars management at both the wholesale and retail levels. Customer-driven financial services lay the foundation for attractive product packages. In addition, our proprietary used car brands were further strengthened and rolled out internationally so as to ensure customer offerings also meet their needs. Cross-brand activities implement examples of best practice throughout the Group, ensuring economies of scale and leveraging synergies.

We established and standardized processes for used cars at all distribution levels, enhanced and increasingly harmonized the underlying IT infrastructure and introduced uniform management performance indicators.



To achieve long-term success in our used car business, we attach considerable importance to stable residual values – in the interest of our customers as well – and have set up system-based reporting functions for this purpose.

#### QUALITY ASSURANCE

The satisfaction of our customers worldwide is crucially driven by the quality of our products and services. Customers are satisfied and loyal only when their expectations of a product or service are met or even exceeded. Reliability, appeal and service determine the quality perceived by the customer throughout the entire product experience. Our objective is to surprise and excite our customers in all these areas so that we can win them over with our outstanding quality. We continued to improve our high level of quality in 2013, thus contributing to growth and to increasing the value of the Volkswagen Group.

Our Quality Assurance consistently focuses on customer wishes and integrates them into product requirements. It ensures that Volkswagen, as the manufacturer, and its products comply with all the legal requirements, defines high quality targets and standards and supervises compliance with them. In addition, Quality Assurance also identifies the cause of any defects and manages the process for eliminating them.

#### Focus on customer wishes

The global growth of the Volkswagen Group poses additional challenges for Quality Assurance. New vehicle projects in the different regions throughout the world are subject to the widest variety of customer desires. In light of this, identifying specific regional factors and prioritizing them is an important task for Quality Assurance so that they can then be integrated into new products, but also so they can be reflected appropriately in the production of established vehicle models. Examples of important factors include the available fuel quality, road conditions, traffic density, country-specific usage patterns and not least local legislation. The Volkswagen Group's strong growth outside of Europe means that the main focus of Quality Assurance is on conditions in the BRIC markets.

We mainly use studies and customer surveys to capture customer requirements in the different markets.

#### Product and supplier quality

In the reporting period, a large number of product start-ups and several new plants starting to operate again made high demands on Quality Assurance. We maintained the high quality of the previous year for the Group and continued to reduce the number of repairs. Our suppliers also made significant contributions to this. We expect sustainable practices from them as well as delivering the highest product quality and reliability of supply.

New vehicle projects entail innovative technologies that must be established in the markets without any problems. This is why Quality Assurance analyzes these projects long before customers experience a new product. The goal is to make products even better and more reliable, while successfully implementing all customer wishes in the new projects and continuing to factor in regional requirements and needs.

In 2013, we continued to standardize our defect elimination process and can now react even more quickly to vehicle problems and help our customers even faster. This both increases customer satisfaction and reduces warranty and ex gratia repair costs for Volkswagen.

#### Service quality

The Service area is also focused on improving the quality of its offerings worldwide. In 2013, we therefore optimized the warranty and ex gratia repair instruments. As the direct interface with customers, the dealership operation offers other starting points: we can identify at an early stage any problems that may be revealed in the emotional moment of vehicle handover and correct them systematically.

We began recalibrating the processes at the interface between markets and dealers in 2012. We successfully continued this project in 2013 and positioned Technical Service even closer to the market, enabling us to recognize and prioritize market disruptions in good time. This is an important condition for being able to quickly start the process for eliminating defects and taking effective measures in services and product ranges so that customer satisfaction continues to grow.

## EMPLOYEES

Excellent performance, the success that comes from it and participation in its rewards are at the heart of Volkswagen's human resources strategy. Only a top team can deliver the excellence that is necessary for Volkswagen to become number one in international automotive production. This human resource policy maxim applies throughout the Group.

As of December 31, 2013, the Volkswagen Group, including the Chinese joint ventures, employed 572,800 people, 4.2% more than at the end of fiscal year 2012. Significant factors in this increase were the volume-related expansion of the workforce in the growth markets, in particular in China, and the recruitment of specialists and experts in Germany, among other places. Volkswagen AG, Volkswagen Sachsen GmbH, AUDI AG and Volkswagen Financial Services AG hired a total of 4,828 temporary employees on a permanent basis in 2013. MAN and Porsche took over 543 temporary employees into the core workforce in Germany.

The ratio of Group employees in Germany to those abroad remained unchanged in the past year: 45.4% of employees worked in Germany at the reporting date, the same as at the end of 2012.

### Vocational training at Volkswagen

Vocational training is a key factor in the development of Volkswagen's outstanding team. This is why Volkswagen has continued to expand its international commitment to the dual education and training system in the vocational groups in recent years. In December 2013, the Group trained 17,703 employees in vocational training worldwide, 12,611 of whom were in Germany.

Dual vocational training and education along German lines now exists at a large number of sites abroad and is in the process of being established at others. For example, Volkswagen offers this at its site in Pune, India, and the Kaluga site in Russia by working together with local business partners and academics.

In 2013, 12 vocational trainees at Volkswagen in Chattanooga, USA, completed a vocational training program in the field of mechatronics for the first time. Local partners here include Tennessee Technology Center, Chattanooga State Community College, Tennessee Technology University and the University of Tennessee-Chattanooga.

Back in 2012, SEAT switched its vocational education and training system in Spain over to the dual model and has integrated the facility more closely as a training location since then.

Every year, the Group Board of Management and the World Works Council present the "Best Apprentice Award" to Volkswagen's best vocational trainees around the world. This prize

was awarded for the thirteenth time in November 2013 in Braunschweig. 40 vocational trainees from 15 countries received the honor.

Volkswagen supports particularly talented vocational trainees in its talent group for young specialists. This is a key instrument for guiding employees who are outstanding at both a professional and personal level through the transition from vocational traineeship to professional practice. In December 2013, 196 talented young people took part in this two-year development and training program; 270 have already completed it.

After completing their vocational training, young people at the start of their career have had the opportunity since 2006 to take part in the "Wanderjahre" (Years Abroad) program, spending twelve months at one of the Group's international locations. Today, 35 Volkswagen Group locations in 19 different countries participate in this development program.

The focus of Volkswagen's vocational training is on professional development, but participants also benefit from a series of supplementary programs and opportunities. For example, Volkswagen vocational trainees have a more than twenty-year tradition of involvement with the Auschwitz memorial site. Prepared and supervised by the International Auschwitz Council and Volkswagen Group Academy, vocational trainees from Volkswagen, its subsidiaries and investees and Polish young people travel to Auschwitz six times a year for two weeks in each case to help maintain the memorial. More than 2,400 young people from Germany and Poland have participated in the program so far.

### Developing university graduates

Volkswagen uses a differentiated approach to support its young academic talent: the Student Talent Bank and the Academic Talent Pool.

Volkswagen has been using the Student Talent Bank since 1998 to develop particularly high-achieving students in both functional and interdisciplinary areas. Since then, nearly 2,300 students have qualified for inclusion in the Student Talent Bank thanks to their committed approach during their internship at Volkswagen. Volkswagen supports these former interns during their further studies and invites them to presentations and seminars by specialists or on excursions to Volkswagen locations, for example.

Talented students are added to the Academic Talent Pool just before they complete their degree or doctorate. This recruiting tool puts selected high potentials on the radar screen at the Company, allowing them to be considered for a qualified entry-level position in one of the functional areas.

Volkswagen's StartUp Direct trainee program gets university graduates off to a flying start in the Company. Over a two-year period, participants in the program not only work in their own department and familiarize themselves with the Company, but also attend supplementary training seminars. Alternatively, university graduates with an international focus can enter the StartUp Cross program. This 18-month international program includes a three-month international placement. Over 2,700 trainees have gained their first experience of Volkswagen in one of these two programs since then. In 2013 alone, Volkswagen AG employed a total of 360 university graduates, around 30% of whom are women.

The Volkswagen Group's StartUp Europe trainee program has offered young engineers from Southern Europe an opportunity to gain international work experience since 2012. This Volkswagen program is designed to attract international talent and is initially targeted at university graduates from Spain and Portugal. The graduates start off in the relevant company abroad before moving to a Group company in Germany for up to 21 months. They may be offered permanent positions after completion of the two-year program.

#### Professional development and training for all employees

For employees to progress personally as individuals within the Company, they have to be supported and given the opportunity to demonstrate their capabilities and develop them further. Volkswagen offers the opportunity for training to all employees within the various vocational groups. A vocational group includes all employees who perform activities based on similar technical skills and work together across experience and development levels. Learning and teaching happens by involving the vocational group's own internal specialists using both tested and new forms of skills development.

Volkswagen is continuously extending and enhancing its mutual learning approach: more and more areas of the Company have vocational group academies in which they organize skills development. The Volkswagen Group Academy was formed in January 2013 as an umbrella organization for all of the Group's academies. It is the result of the reintegration of Volkswagen Coaching GmbH and a merger with the AutoUni. The new structure is an integrated qualification platform that leverages synergies and ensures high quality and expertise levels throughout the Group. It covers everything from vocational training up to and including academic professional development.

The Volkswagen Group is also driving forward uniform global training and professional development standards for master craftsmen and future executives and managers. These standards were rolled out at additional Group locations in Germany and abroad. Overall, 322 master craftsmen qualified at Volkswagen in the reporting period, including 84 abroad.

There are also many tailored training opportunities for other professions in the Group. First and foremost is Volkswagen AG's Volkswagen Group Academy, which offers a broad range of courses. These include personal development programs, interdisciplinary seminars and courses, and specialized training options designed for the particular needs of individual vocational groups. In the reporting period, 86,316 participants received further training at the 10,060 seminars held by Volkswagen Group Academy lasting a total of 213,678 participant days. In the area of specialist skills development (e.g. factory automation, robotics, applications engineering and business), 56,554 participants took part in 7,591 seminars lasting for 126,976 participant days. In the field of "crossfunctional skills development" (which includes leadership skills and personal development), 29,762 participants attended 2,469 training courses for a total of 86,702 participant days. To ensure that its range of training options always keeps pace with the Company's training needs, an additional 369 new training courses were developed in 2013.

#### Professional development at university level: the AutoUni

The AutoUni, which operates under the Volkswagen Group Academy umbrella, ensures the availability of specialized academic knowledge within the Volkswagen Group. The educational offerings, which are developed in conjunction with the partner universities, are tailored to the needs of the vocational groups. With its eight institutes, the AutoUni offers numerous lectures, conferences, programs and cooperative study modules at university level. Cooperative study modules are used to study scientific topics in more detail and finish with an exam. Programs at the AutoUni, which is based in Wolfsburg, are being rolled out internationally, a process that dates back several years. In 2013, they were extended to the Group sites in Bratislava, Mladá Boleslav, Martorell, Shanghai and Beijing, among other places. One of the focuses was on future mobility: electric traction, innovative drivetrains and lightweight construction as well as sustainable transportation systems.

The AutoUni is also heavily involved in the Group's doctoral student program. More than 420 doctoral students were supervised in 2013 at the various Volkswagen Group companies in Germany. The doctoral students conduct research on ambitious PhD thesis topics that are relevant for the Company. During this time, they work closely with the department they have been assigned to in the Group, which also appoints a supervisor within the Company for them. The AutoUni supports doctoral students by providing seminars on academic writing and its doctoral colloquium offers the opportunity to present ongoing dissertations and discuss them in public within the Group.

#### Advancement of women, family-friendly HR policies

Volkswagen's corporate culture places a very high value on both job and family. For Volkswagen, family-friendly human resources policies are a key success factor along the road to becoming one of the world's leading employers. In spring 2011, the Volkswagen Group proposed individual goals to raise the proportion of women at Volkswagen in Germany for the long term as part of a voluntary commitment.

A pioneering instrument is the quota for the university graduates we hire. Volkswagen hires the year's best university graduates in the necessary fields and then trains them further. It is guided in this by the proportion of female graduates in each field of study. Consequently, approximately 10% of graduate engineer recruits have to be women. For electrical engineering, the ratio is also 10% and for business and economics 50%. Averaged across all fields of study relevant to Volkswagen, the individual ratios produce an overall goal of at least 30% women among the university graduates hired.

#### PROPORTION OF WOMEN VOLKSWAGEN GROUP IN GERMANY\* as of December 31, 2013

%	2013	2012
<b>Total vocational trainees</b>	<b>27.4</b>	<b>26.8</b>
Industrial vocational trainees	21.4	20.9
Commercial vocational trainees	53.2	52.3
Students in traineeship schemes	31.4	31.3
<b>Total management</b>	<b>9.8</b>	<b>9.3</b>
Management	11.2	11.0
Senior management	7.9	7.0
Top management	4.8	5.5

\* Excluding Scania, MAN and Porsche.

Volkswagen approaches female students at an early stage. For example, it uses its Germany-wide Woman DrIVING Award and the Woman Experience Day to focus on female engineering students and graduates so as to recruit them for technical positions at Volkswagen.

This increased proportion of qualified women joining the Company will enable us to steadily lift the proportion of female executives in the coming years. The Volkswagen Group is aiming to have 30% women at all levels of the management hierarchy in Germany in the long term. In line with this, the proportion of women at the Volkswagen Group in Germany increased from 9.3% (2012) to 9.8% (2013). 40 women at Volkswagen AG participated in the Company's mentoring program in 2013, which is designed to support them as they transition to management.

Volkswagen also has the goal of raising the proportion of women among its skilled workers and master-level workers in Germany to 10%. In 2013, 30 women at Volkswagen AG took part in the master craftswoman mentoring program.

With 27.4% female vocational trainees in 2013, and especially with 21.4% in the industrial and technical area, the Volkswagen Group is one of the leaders in the automotive industry in Germany. We aim to increase this to around 30%. Volkswagen therefore specifically recruits female talent, for example by offering special information days for industrial and technical vocational training at Volkswagen and career experience days for young women. The Company has participated in the national "Girls' Day" in Germany for years and offered roughly 2,200 schoolgirls a behind-the-scenes look into careers in the automotive industry in the reporting period.

In addition to hiring and supporting talented female employees, Volkswagen is attempting to systematically improve its employees' work/life balance. This includes a high level of working time flexibility and a range of part-time and shift models, as well as easing the transition back into the workforce for employees on parental leave. Teleworking and the associated use of new IT and communications technologies allow employees to find their own individual work/life balance.

Another step toward becoming a family-friendly company is the constant expansion of a range of childcare options. Since 2013, childcare is now available during school vacations at all Volkswagen AG locations for the first time. Volkswagen Sachsen GmbH and Volkswagen Osnabrück GmbH also added childcare during school vacations as of the reporting period; this has been implemented at AUDI AG since 2011.

The Volkswagen Group's experience with near-site childcare facilities has been positive. For example, MAN offers company childcare facilities at its Munich and Augsburg locations. Volkswagen Financial Services AG's "Frech Daxe" kindergarten is one of the largest company childcare facilities in Germany. Childcare has been available at Volkswagen Group of America's Chattanooga location since 2012.

**AGE STRUCTURE IN YEARS OF VOLKSWAGEN GROUP EMPLOYEES\***  
as of December 31, 2013; in percent

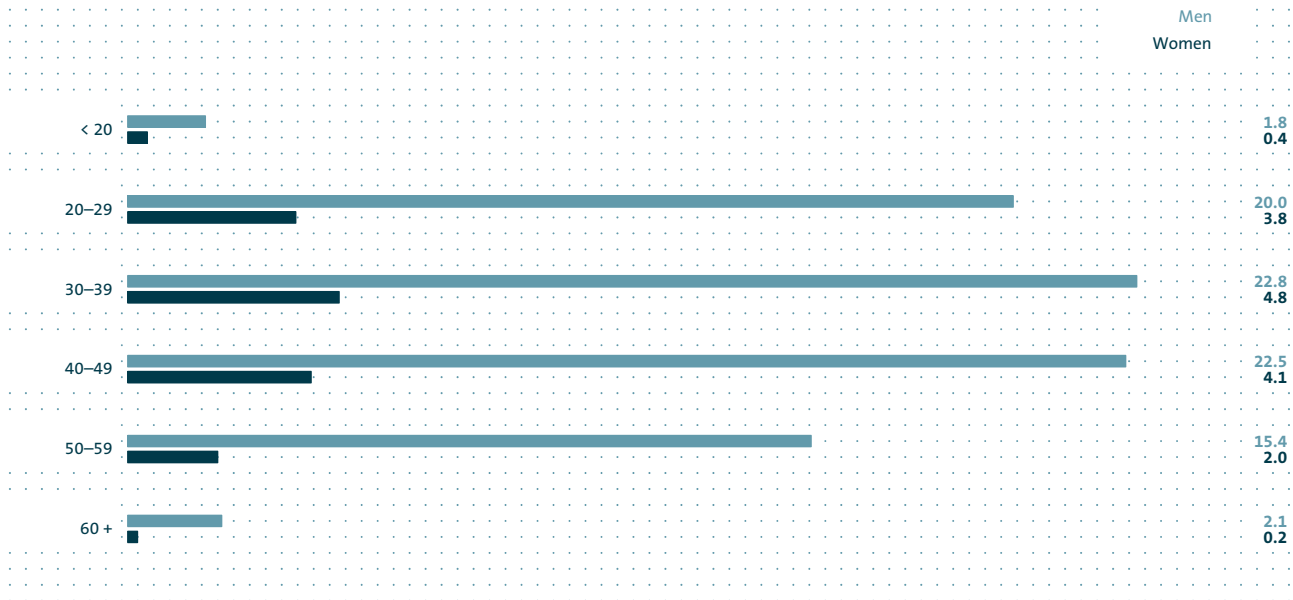

\* Excluding Scania and MAN.

**Performance incentives and bonus arrangements**

Systematically encouraging and recognizing achievements and switching to remuneration systems that allow employees to share in the Company's success for the long term are another component of our human resources strategy. Universal and uniform criteria for skills development and performance evaluation have been in place at Volkswagen AG since 2010. These apply to the entire workforce – from vocational trainees to senior executives. The criteria are underpinned by concrete incentive systems in the remuneration structure.

Volkswagen AG's employees covered by collective pay agreements have a remuneration system that comprises three key elements:

- > basic pay in the form of a competitive monthly salary,
- > a performance-based remuneration component, which recognizes the achievements of each individual employee, and
- > the right to a bonus arrangement anchored in the collective pay agreements.

This three-tier remuneration system has proven its worth as a tool for the workforce to participate in the Company's success. At the same time, it helps recognize individual achievements while maintaining competitiveness. It is therefore being increasingly implemented as the standard throughout the Group.

**Employee participation**

Employees can actively help shape the Company by participating in the opinion survey. This uniform, Group-wide employee survey gathers information about employee satisfaction once a year. Following the survey, the results are discussed together by supervisors and employees. Complaints and problems are addressed, as are suggestions on how to better organize work. The measures agreed are then implemented before the next survey. The opinion survey was conducted for the sixth time in 2013. A total of 121 locations and companies in 40 countries were included in the survey. More than 400,000 of the over 450,000 employees invited to participate took part. This corresponds to a participation rate of 89%.

Employees from Porsche, MAN, Volkswagen Group Retail Deutschland GmbH and Volkswagen Group Polska Sp. z o.o took part for the first time. The sentiment rating is a key parameter for the opinion survey, in addition to the level of employee participation. In 2013, this was 79 (79) out of 100.

Another instrument – and one whose success depends significantly on employee involvement and participation – is the "Volkswagen Way". This has been an integral feature at Volkswagen for six years. It aims to safeguard competitiveness and employment in equal measure. It focuses on a permanent improvement process

that aims to achieve continuous process optimization in the areas of productivity and quality, ergonomics, leadership and teamwork. In the reporting period, a particular focus was on optimizing overarching workflows. In addition to the “Volkswagen Way”, the Group also has similar programs designed to optimize processes and structures. For example, during production, a uniform Group-wide production system is used for all brands.

Employees use their creativity, knowledge and initiative to take responsibility for process and product improvement under the Ideas Management program. Employees have submitted approximately two million ideas since 1949 using the suggestion scheme in place at that time and today’s Ideas Management program, saving nearly €3,000 million at Volkswagen AG and Volkswagen Sachsen GmbH locations. Ideas Management is an important leadership and motivational instrument for line supervisors. It also helps make work at Volkswagen safer and more compatible with good health.

**IDEAS MANAGEMENT IN THE VOLKSWAGEN GROUP\***  
as of December 31, 2013

	2013	2012
Ideas suggestion	532,053	536,532
Suggestion implemented	412,795	380,475
Savings in € million	312.5	358.1
Bonuses in € million	34.9	34.1

\* 31 (30) participating production locations.

**Preventive healthcare and occupational safety**

Healthcare management at Volkswagen is much more than classic preventive healthcare and occupational safety. The comprehensive healthcare management system that is in place at Volkswagen also covers aspects of work organization, ergonomics, leadership and prospects for all individuals.

The “CheckUp”, a free, comprehensive medical examination, was made available to all employees at Audi in 2006 and at Volkswagen in 2010. This tool helps to maintain and improve employees’ health, fitness and performance. The high level of diagnostic quality is widely acknowledged by employees: nearly 61,000 Volkswagen check-ups and almost 60,000 Audi check-ups have been performed to date.

Now that the check-ups have been established at the German locations, associated internal and external prevention and training programs are now being systematically expanded. In addition, the large-scale rollout of the Volkswagen CheckUp was continued at the international locations. Existing screening programs were adapted to meet the Group-wide standard represented by the CheckUp, for example at ŠKODA AUTO a.s. in 2013. More than 15,000 ŠKODA check-ups have already been performed since then.

At the same time, Volkswagen uses improvements along the entire product development process to guarantee that the quality of workplaces and the strains on employees that arise as a result of production are already taken into account in the planning and design stages of vehicle models. The common objective is to combine ergonomically state-of-the-art workplaces and innovative work processes, using a mix of science and practical experience. The deployment of occupational assistants on the production lines means that employees are able to receive advice and guidance directly at their workplace about how to implement their workflows more ergonomically.

In the course of our management development programs, line supervisors are taught to give stronger consideration in their leadership practices to the link between leadership and employee health. We have also implemented compulsory training modules on occupational safety for all prospective managers since the beginning of 2012. In the same way, the training components for prospective master-level craftsmen were standardized in 2013.

Using the Group occupational safety management system, all Group companies covered by it analyzed their existing occupational safety organizations and processes. The results are available throughout the Group in a central database system. This includes the systematic communication of examples of good practice identified in the Volkswagen Group.

### Social benefits

Volkswagen AG tops up the benefits provided by social insurance institutions, such as sick pay, and supports dependents when an employee dies. All Volkswagen AG employees are also insured by a group accident insurance policy against accidents resulting in death or disability. Volkswagen AG also grants short-term loans in exceptional cases of economic hardship.

Employees in the Group companies in Germany and abroad enjoy additional benefits. Depending on the location, these include transportation and subsistence allowances, affordable housing, monthly childcare allowances as well as subsidies towards selected leisure activities. Additional preventive healthcare services or supplementary pension insurances round off this offering on a location-specific basis.

Volkswagen AG and its brand companies and subsidiaries operate an occupational pension system, making an important contribution to their employees' retirement income. The direct pension commitment at Volkswagen AG comprises the basic pension and the retirement benefits under contributory pension schemes I and II. While the basic pension and contributory pension scheme I are funded by the employer, contributory pension scheme II offers employees the opportunity to provide for their own retirement income through deferred compensation. Direct insurance is another opportunity for employees to provide for their own retirement income through deferred compensation.

Volkswagen AG's Time Asset is an instrument that gives staff the opportunity to retire earlier. Since 1998, employees have been able to make contributions from their gross salary and time credits. The accumulated Time Asset credits can be used for paid early retirement.

### EMPLOYEE BREAKDOWN<sup>1</sup> as of December 31, 2013

	2013	2012	2011	2010	2009
Vocational trainees in the Group	17,703	16,714	15,021	10,545	9,846
Industrial	13,174	12,508	11,249	7,799	7,439
Commercial	4,529	4,206	3,772	2,746	2,407
Passive stage of partial retirement	9,501	7,804	4,488	4,778	7,070
Group's active employees	545,596	525,245	482,447	384,058	351,584
<b>Employees</b>	<b>572,800</b>	<b>549,763</b>	<b>501,956</b>	<b>399,381</b>	<b>368,500</b>
Europe	424,964	410,427	378,030	290,159	278,779
America	61,796	63,193	58,072	54,571	48,529
Africa	6,356	6,461	6,602	6,546	5,608
Asia	78,672	68,704	58,540	47,607	35,123
Australia	1,012	978	712	498	461
Percentage of female employees in the Group	15.5	15.2	14.7	14.2	14.2
Female graduate recruits <sup>2</sup> (in %)	35.3	29.2	30.5	23.6	22.4
Number of accidents at work <sup>3</sup> (thousands)	1.9	1.7	1.8	1.9	1.9
Accident value <sup>3</sup>	0.003	0.003	0.003	0.004	0.004

1 Including the Chinese joint venture companies.

2 Volkswagen AG

3 Production locations excluding Scania, MAN (also excluding Porsche in 2012, also excluding Audi Brussels in 2009); accident value = number of accidents at work x 1,000 / number of hours worked.

#### INFORMATION TECHNOLOGY (IT)

The communication society, the nearly universal information technology support for business processes and the development of new locations continually pose new challenges to the IT functions of large companies. An adequately equipped IT infrastructure, both technologically and quantitatively, is the foundation for stable IT systems and thus for optimal IT support.

Ensuring that new developments in the application landscape are passed on efficiently to the different corporate locations and incorporated into business processes and the sales network is just as vital as having a modern IT infrastructure. The IT staff are responsible not only for programming the systems at all of the Volkswagen Group's brands, but also for supporting users in Technical Development, Production and Sales. This is how applications tailored to the exact needs of the users are created. Volkswagen's factory planners can use the "digital factory", for example, to virtually walk through the future production buildings long before the ground is broken. IT support ensures that employees on the production line can build the right vehicle at the right time using the Group-wide "Fertigungs-, Informations- und Steuerungssystem" (FIS – Production, Information and Control System). Expert teams on the ground develop solutions that can be applied globally and across brands for all of these IT services. In this way, Volkswagen establishes IT standards in its business areas that also form a basis for leveraging potential synergies.

In addition, customers expect to find innovative communications technology and IT in the Volkswagen Group's vehicles – such as networking the vehicle to the Internet, or apps tailored to meet individual needs. The Audi brand's "Audi Connect" system has been further developed into a modular system that can be used by other brands in the Group. The "Car Net" services introduced with the Golf GTI are based on the same approach, for example. The services are operated across all the brands through regional data centers. Data security is another top priority alongside functionality. Volkswagen applies the highest security standards when transferring data between vehicles and data centers.

Volkswagen's employees are systematically educated and trained so that, combined with reliable IT security systems, the risk of sensitive data being accessed by unauthorized persons is reduced. A Group-wide information security campaign that addresses the management of sensitive data has been in place since 2012.

#### ENVIRONMENTAL MANAGEMENT IN THE GROUP

The Group has set itself the target of becoming the most sustainable automobile company in the world by 2018. The Group's environmental strategy is the framework through which the Company will become a leader in ecological terms.

By 2018, we aim to reduce energy and water consumption, emissions and waste in relation to vehicles at all of our sites by 25%

compared with 2010. The charts on page 138 illustrate our progress in fiscal year 2013. The collection of key environmentally relevant consumption and emissions data on the basis of VW standard 98,000, which is applicable throughout the Group, is subject to a continual improvement process. The information that must be calculated using special algorithms is particularly affected by these optimization measures. Additionally, the integration of new Group brands and locations requires adjustments in the time series that have already been reported. The improved and updated environmental data collection process aims to increase the degree of accuracy and consistency of the information gathered.

Alongside efficient and resource-friendly production as well as the design of intelligent mobility concepts for the future the development of environmentally friendly vehicles is also one of our key action areas: we aim to reduce the CO<sub>2</sub> emissions of our European new vehicle fleet to 95 g/km by 2020. In addition, every new model generation is designed to be 10% to 15% more efficient than its immediate predecessor.

In order to successfully implement our environmental strategy, we must model all environmentally relevant aspects in our organizational and decision-making processes, both in product development and production at all locations. This is why we have a holistic environmental management program, which has already been established in the Group for many years. The main pillars of this are the Group's globally applicable environmental principles for products and production and the environmental goals of the Technical Development function. Since 2010, these efforts have been supported by a Group-wide energy management system. Teaching our employees about ecological issues is also an important factor in reaching our goals. For this reason, we employ environmental protection experts and environmental officers around the world, who help to build a broad foundation for environmental protection within the Group.

Since 1995, Volkswagen's German locations have voluntarily participated in the EU's Eco-Management and Audit Scheme as well as worldwide in the environmental certification process under international standard ISO 14001. Since 1996, the environmental management system used by Volkswagen's Technical Development function has been certified in accordance with ISO 14001 and, since 2009, additionally in accordance with ISO/TR 14062. By means of recertifications and external validations, we also confirmed our role as a trailblazer in the reporting period.

Our Group environmental strategy takes a holistic approach that takes into account the lifecycles of our products. To do this, we chose a modular structure whereby the modules are oriented on business areas along the entire value chain. Thus we not only address environmental issues relating to production and the products themselves, but also in logistics or recycling, for example. We defined a fixed committee and reporting structure to manage



these issues. The responsible parties are globally networked, enabling the systematic exchange of examples of best practice. In fiscal year 2013, at a global Group strategy workshop, we put together an ambitious package of measures together with all of the business areas and established the responsibilities and reporting structures.

A summary of our ecological activities and a supplementary overview of our key environmental indicators can be found at [www.volkswagenag.com/sustainability](http://www.volkswagenag.com/sustainability).

#### Climate protection

Based on our environmental strategy, protecting the climate is one of our key challenges because we have a special responsibility as a company that produces over 9.7 million vehicles a year. This applies not only to the production conditions at our own production sites, but also to the supply chain and the products over their entire lifecycles.

We consider climate change and the resulting risks and opportunities in all of our strategic decisions. These decisions are based among other things, on information provided by the CSR & Sustainability steering group and the Group's CO<sub>2</sub> steering group. A key instrument is the "CO<sub>2</sub> Registry" management and analysis tool, for example. This analyzes every one of the Group's vehicle projects over the entire production process with regard to their CO<sub>2</sub> emissions, based on the requirements for CO<sub>2</sub> savings laid down in our Group environmental strategy.

We established a Group Expert Network for Climate and Energy to facilitate the exchange of knowledge and experience between all brands and regions. The Network's focus, alongside exchanging best practice approaches, is to discuss issues with international scientific experts (for example, representatives of the International Energy Agency) and other stakeholders (for example, the World Business Council on Sustainable Development).

#### Water management

Water is not just a means of subsistence, but also a means of production and a source of energy. In many parts of the world, however, there is no basic provision of this essential commodity. In automobile production, it is impossible to avoid using water, however – in washing processes in mechanical manufacturing or process cooling, for example. Volkswagen is aware of its responsibility and thus uses this valuable resource sparingly. Using water sparingly is also laid down in the Group's environmental principles: three of the 22 environmental principles for production relate directly to the issue of water.

Volkswagen has participated in the Water Disclosure Project (WDP) since 2011. This nonprofit organization collects information on water management in a comprehensive annual survey, and analyzes and evaluates the data. Volkswagen is the only German automotive group to agree to publish the results. We are thus trailblazers when it comes to the disclosure and transparency of our

careful use of water and newly developed solutions for sustainable water management. Furthermore, since 2013, Volkswagen has been the first automotive company in the world to support the CEO Water Mandate.

Volkswagen has set itself the goal of reducing water consumption per vehicle in all plants by 25% by 2018 compared with 2010. During the reporting period, we implemented numerous measures in the plants to do this, showing that we are reducing the overall pollution of bodies of water attributable to vehicle production and at the same time ensuring a secure water supply.

The Foshan plant was the first facility in China to be awarded the Triple-Star Green Building Award – the highest state award for environmentally friendly factory planning. Almost all waste water at this location is treated and reused using state-of-the-art membrane technology. In engine production at the Salzgitter plant, no industrial waste water is created either because waste water containing oil is separated into oil and water in vacuum evaporators. The water claimed in this process is used to prepare emulsions. This helps us save 30,000 m<sup>3</sup> of water a year. We also use energy-efficient evaporators at other Group locations, such as the Slovakian plant in Martin or the Polkowice plant run by VW Motor Polska. We use the resulting distillates as recycled water and for cleaning. Additionally, the amount of liquid and dangerous waste containing oil is being reduced by up to 40%.

The significant requirement for cooling water in the industrial production of automobiles means that there is also considerable potential for water savings in this area. When a new combined cycle power plant was constructed in Kassel, a nanofiltration plant was commissioned that helps save water in cooling tower operation. Thanks to this nanofiltration plant, we can treat waste water containing salt so that the water can be reused, allowing fresh water to be saved and up to 70% less waste water to be discharged.

The waste water cleaned in Volkswagen's sewage treatment plants meets the highest global standards. We guarantee this by using state-of-the-art biological waste water purification technology, for example in the Pune plant in India. There we use a membrane bioreactor: the combination of microbial breakdown and filtration through extremely fine membranes means that over 99% of all biologically degradable components can be removed from the pre-treated industrial waste water. Thanks to this process, the water can be reused at the site.

We are also proving the high quality of our sewage treatment plants and waste water in a cooperative project between Volkswagen Slovakia and Comenius University in Bratislava: together we have been breeding crayfish that are supplied with purified waste water from the Volkswagen sewage treatment plant. The water provides optimal living conditions for the threatened crayfish. Volkswagen is supporting the return of crayfish to their natural habitat by reintroducing the farmed animals into the wild.

**ENERGY CONSUMPTION\***  
*in kilowatt hours per vehicle*

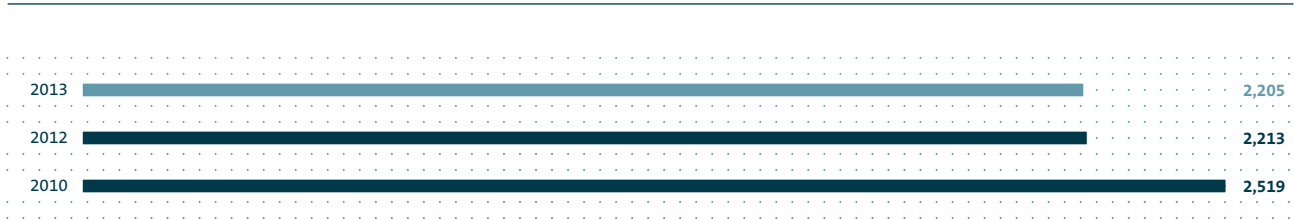

**CO<sub>2</sub> EMISSIONS\***  
*in kilograms per vehicle*

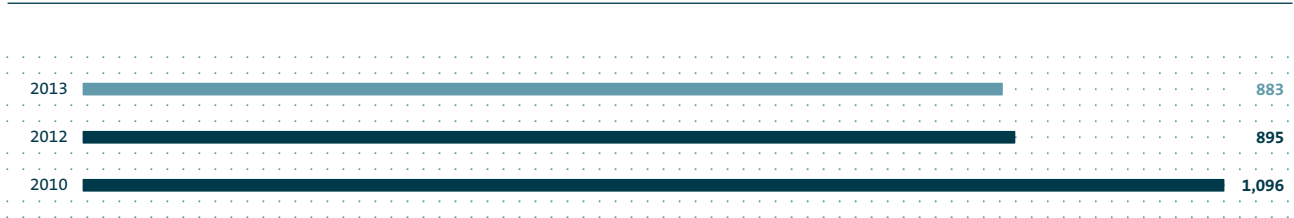

**VOC EMISSIONS (VOLATILE ORGANIC COMPOUNDS)\***  
*in kilograms per vehicle*

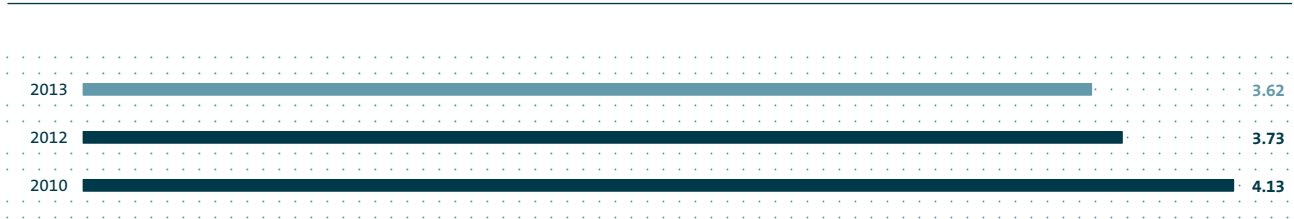

**DISPOSABLE WASTE\***  
*in kilograms per vehicle*

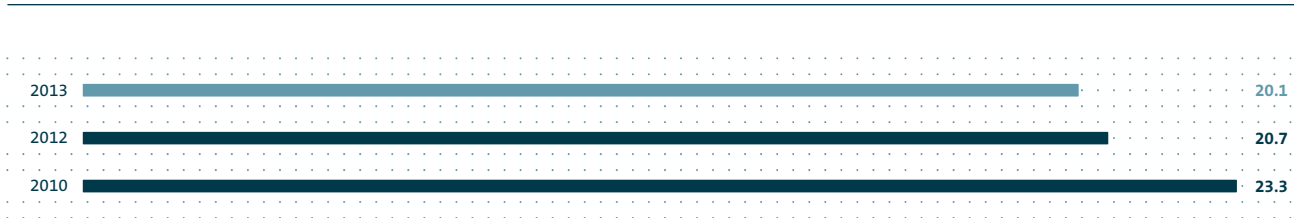

**FRESH WATER CONSUMPTION\***  
*in cubic meters per vehicle*

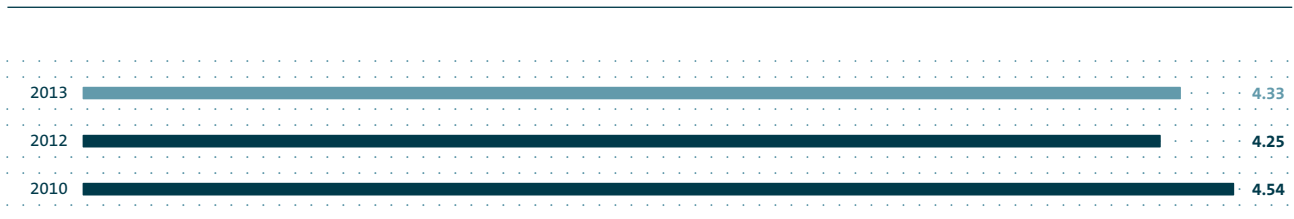

\* Production of passenger cars and light commercial vehicles. Prior-year figures adjusted.

#### Noise reduction

Responsible concern for the environment means that an automobile manufacturer must consider the full range of its vehicles' effects. Increasingly, this includes the topic of traffic noise. Volkswagen is facing up to this responsibility, not only by developing ever quieter vehicles, but also through extensive activities to reduce overall traffic noise. Our goal is to better understand the influence that cars have on traffic noise so as to identify which tasks will be assumed in the future by vehicle manufacturers and when – as part of a comprehensive approach – there is a need for cooperation with other participants.

We developed a so called noise level tool in collaboration with the internationally renowned firm of Lärmkontor GmbH, Hamburg. Using this tool, we will be able to compare measures to quantitatively reduce noise in a model city in terms of its effect on the noise level on the whole as well as on the number of those affected. The control variables of the noise level tool include traffic volume, the proportion of passenger cars and commercial vehicles, speed, road surface, engine noise and rolling noise. The innovative feature of the tool is that it indicates noise pollution, illustrating how much noise is "perceived" by how many of the city's inhabitants. Looking exclusively at the sources of noise produced – that is, the emissions – would give a skewed picture of the effectiveness of noise-reduction measures. Our focus on those affected by noise is also demonstrated by the continual exchange we maintain with representatives of municipal authorities, which we intensified in 2013. For example, Volkswagen is participating in the city of Wolfsburg's measures to reduce noise.

These activities are examples of our contribution to ensuring that future steps towards reducing noise are better coordinated and that funds can be used more selectively.

#### Lifecycle assessment

Reducing fuel consumption and the associated reduction of emissions are important measures for improving the environmental credentials of our vehicles. However, these alone do not reduce a car's environmental impact to a minimum. After all, this does not begin when it starts being driven by the customer. The raw materials for the vehicle must also be produced, and materials and components manufactured – and this long before the wheels of a new car turn for the first time.

To be able to reduce the environmental impact of a vehicle to a minimum, the entire product lifecycle is considered when vehicles are developed. This means that the assessment of the potential environmental impacts of new vehicles, components and materials begins before they are even produced: effectively from the first idea and design sketches, through production and the subsequent usage phase, down to disposal. Volkswagen uses the environmental impact study – or lifecycle assessment – in accordance with ISO

standards 14040 and 14044 as a tool for this. Using environmental impact studies, we determine where improvements have the greatest effect and develop targeted innovations accordingly. We call this approach lifecycle engineering.

The Volkswagen brand publishes environmental ratings to inform its customers, shareholders and stakeholders about its success stories in environmentally responsible vehicle development and lifecycle assessments. Environmental ratings for new vehicle models demonstrate ecological advancements in direct comparison with the predecessor model. For the communication to be credible, it is important that the results and evaluations in the environmental impact studies meet internationally recognized quality standards and are transparent, comparable and understandable. In order to ensure this, the results of the lifecycle assessments are reviewed, confirmed and certified by independent experts, in accordance with the requirements of ISO 14040.

#### External environmental awards

The Volkswagen Group and its brands and projects received numerous awards for environmental protection and sustainability in 2013. Here are some examples:

For the second time, the Volkswagen eco up! heads the environmental vehicle list published by Verkehrs Club Deutschland (VCD), the German association for sustainable mobility. It is on a level with the ŠKODA Citigo CNG and SEAT Mii Ecofuel models produced by other Group companies, with the three being named the most environmentally friendly vehicles of the year. The VCD's evaluation considers CO<sub>2</sub> emissions, drive-by noise and the specific emission standard met by the vehicle.

The magazine "verkehrsRUNDSCHAU", together with its sister publication "Trucker", awarded the Volkswagen Crafter the "Green Van 2013" environmental prize, rating it the most environmentally friendly transporter. Key to its success was primarily its categorization in the enhanced environmentally friendly vehicle (EEV) emission standard for all performance classes, alongside its low consumption.

The strategic stakeholder dialog between Volkswagen and the German Nature and Biodiversity Conservation Union e.V. (NABU) is also seen externally as an example of best practice. This once again received second place in the 2013 European Change Communications Award in the "Strategy large" category and was a finalist in the 2013 PR Report Awards in the "Responsibility/CSR" category.

Finally, the Volkswagen Group received the German Investors' Award for Responsible Business Practices, which is sponsored and awarded by the magazine publisher DuMont and Deutsche Asset & Wealth Management. The jury praised the way sustainability is anchored in the core business and the responsible attitude towards all stakeholders and towards nature.

### Biodiversity

Together – and in connection with – climate change, the dramatic loss in species, ecosystems and genetic diversity is one of the greatest challenges of our time. The United Nations has therefore declared the current decade as the UN Decade on Biodiversity.

Every company's value added depends – directly or indirectly – on nature's achievements. And every company has an impact on nature and ecosystems, to their benefit or detriment. The loss of biodiversity means that the quality of the "services" provided to us for free by natural ecosystems also suffers. An economy that acts to maintain and use biodiversity sustainably does so in its own long-term interests.

Protecting natural resources has been a corporate goal at Volkswagen since 2007, consistent with the UN's Convention on Biological Diversity. We continued to drive forward integration of this topic with our processes and systems in the reporting period. As an industrial enterprise, we contribute to protecting biodiversity primarily by reducing greenhouse gas emissions and other environmental impacts caused by production. Initiatives in nature and species conservation and in promoting and integrating biotopes – together with expert project partners – supplement our biodiversity management activities.

Volkswagen again actively used the "Biodiversity in Good Company" corporate initiative we co-founded as a platform for learning and dialog and supported its further national and international integration. For example, we participated in the kick-off event for "Enterprise Biological Diversity", a platform of associations initiated by the German Federal Ministry for the Environment in 2013, the management of which was entrusted to the "Biodiversity in Good Company" initiative. Our cooperation in the research project studying the impact of product systems on biodiversity, led by the Fraunhofer Institute for Building Physics with the cooperation of the Federal Agency for Nature Conservation, the Federal Ministry for the Environment and the German Federal Environmental Agency, served to operationalize the goal of protecting biodiversity from a corporate perspective.

As part of a long-term strategic stakeholder dialog, Volkswagen also receives expert advice from the largest and most important environmental organization in Germany, the Nature and Biodiversity Conservation Union e.V. (NABU), whose core concerns are nature and species conservation. The common objective of Volkswagen and NABU is to translate pure dialog into concrete projects that contribute to protecting biological diversity.

The following examples from the reporting period illustrate this:

- > Thanks to the German Moor Conservation Fund established by Volkswagen Leasing GmbH and NABU in 2011, the rewatering program for moors in Germany was extended.

- > Support for Europe's largest river restoration project on the Lower Havel river took on a new level of quality when we made a donation to reconnect the Schliepenlanke oxbow lake in Rathenow.
- > The "Willkommen Wolf!" wolf conservation initiative continued with a roadshow through zoological gardens and animal parks, with 40 stops overall.

We provide continual updates about these and other projects at [www.mobil-fuer-mensch-und-natur.de](http://www.mobil-fuer-mensch-und-natur.de), which presents the development of the alliances. For example, Volkswagen is protecting water habitats in and around the entire Allertal valley in Lower Saxony in collaboration with the Federal Agency for Nature Conservation and the Otter Center in Hankensbüttel.

Volkswagen promotes the conservation of nature and species diversity not only in Germany, but also in other international Volkswagen Group locations and all around the world. This includes Volkswagen de México's "Por amor al planeta" program, for example, which conducts scientific research into biodiversity in nature reserves among other things, and also the public-private partnership project between Volkswagen do Brasil and the São Carlos Ecological Park to protect the habitats of endangered species such as the Cerrado wolf, the Andean condor and the Andean bear.

### Fuel and drivetrain strategy

In fiscal year 2013, we made further progress towards implementing our vision of sustainable mobility. Efficient and sustainable drivetrains are a highly important strategic issue for Volkswagen and part of the product strategy. We are not only working to continuously optimize existing drivetrains but also – as in the past – pursuing a variety of alternative concepts, and especially electric traction. At present, our customers around the world primarily choose conventional engines to drive their vehicles. Until carbon-neutral and sustainable mobility is a reality, electrified drive technology and conventional combustion engines will continue to coexist in the future. This coexistence will be flanked by a steady increase in the share of carbon-neutral energy sources, in the form of renewable power for electric vehicles, for example, or carbon-neutral fuels such as the next generation of biofuels. Of particular significance here are biomethane, which is generated from waste materials, and synthetic natural gas. The latter is produced in electrolysis and methanation plants fueled by renewable wind power. Today, almost carbon-neutral mobility is already a possibility using sustainable natural gas. Volkswagen has continually expanded its offering of vehicles with CNG drives in recent years. In addition, we are examining innovative renewable fuels that bind CO<sub>2</sub> during production and that put carbon-neutral mobility within grasping distance.

THE ROAD TO CARBON-NEUTRAL MOBILITY

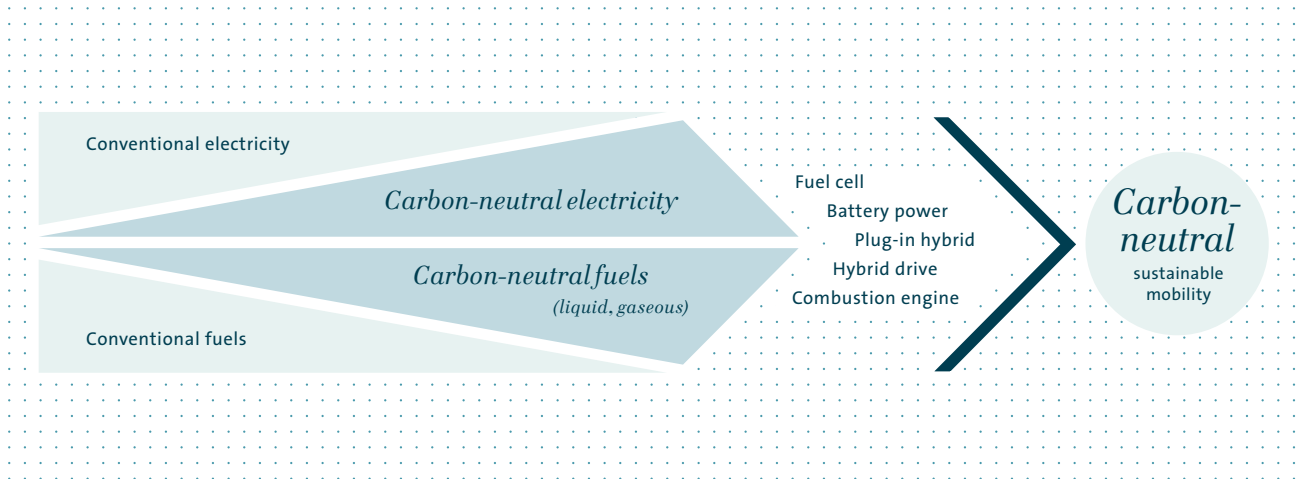

From today’s perspective, the combustion engine looks set to serve as the broad basis for drive technology in the coming years. This is particularly true for growth markets such as Russia, India and the Far East. Given the need to use resources responsibly, it is crucial to further optimize combustion engines so as to facilitate sustainable, forward-looking mobility. We have developed an entirely new generation of petrol and diesel engines in response to this challenge. These drivetrains were used in the successor models for the Audi A3 and Golf for the first time in 2012, and will be successively added to the Volkswagen Group’s vehicle range in the future.

All the new engines feature turbocharging, direct injection and a start-stop system as a standard feature. Alongside intelligent thermomanagement for reducing mechanical and energy losses, they also make use of other fuel-saving technologies such as demand-driven auxiliary power unit management and variable valve management. In addition, they feature energy recuperation. We have been using active cylinder management in many Group vehicles with petrol engines since 2012. This automatically switches off individual cylinders when they are not needed without the driver noticing. This innovative technology cuts fuel consumption by up to 0.5 l per 100 km, depending on the engine and driver profile involved. Active cylinder management is increasingly being used in new models.

Driver profile selection is another means of reducing fuel consumption. In 2012, it was integrated into a volume model – the new generation of the Golf – for the first time; it is now also available in other Volkswagen Group vehicles. The driver can select the eco, normal and sport modes as desired. Engine and gear management

as well as auxiliary power units and the air conditioning are activated as necessary according to the driver’s selection.

The Group’s efficiency models show what can be achieved by combining efficient conventional drives and vehicle innovations such as low rolling resistance tires and aerodynamic measures. At Volkswagen, they are available under the “BlueMotion” label, at ŠKODA they are known as the “GreenLine” models and at SEAT they go by the name of “ECOMOTIVE”. With CO<sub>2</sub> emissions of 87 g/km and fuel consumption of only 3.3 l per 100 km, the Polo BlueMotion is one of the most environmentally friendly and economical five-door vehicles in the world. The Golf BlueMotion, with its new 1.6 TDI engine, uses an average of only 3.2 l of fuel per 100 km, while its CO<sub>2</sub> emissions are a mere 85 g/km. The ŠKODA Octavia GreenLine emits only 85 g/km of CO<sub>2</sub> and uses 3.2 l of diesel per 100 km. The eco up! – available since the end of 2012 – has CO<sub>2</sub> emissions of just 79 g/km with its 1.0 CNG engine.

The Audi and Porsche brands provide impressive proof that premium-segment diesel engines can also be dynamic and economical. The twin turbocharged 3.0 TDI engine in the Audi SQ5 TDI has an output of 230 kW (313 PS) and uses a mere 6.8 l of diesel

per 100 km. Porsche offers the Cayenne S diesel with a twin turbo-charged 4.2 l V8 diesel engine and an output of 281 kW (382 PS), consuming just 8.3 l of diesel per 100 km.

The successful TSI, TFSI and TDI engines, ideally combined with the Group's innovative direct shift gearboxes (DSGs), offer a good starting point for efficient vehicle propulsion now and in the future, as they can be combined on a modular basis with electrical components to produce hybrid drives. The plug-in versions of such vehicles can be recharged via electrical outlets and – depending on the model concerned – can cover between 20 and 80 km in purely electric mode.

When it comes to drive electrification, hybrids are a core topic for the Volkswagen Group, especially plug-in hybrids. They are currently the best way of supplementing petrol and diesel engines, because they combine the benefits of two technologies and hence meet a number of customer expectations: an unlimited range thanks to their combustion engines, an attractive electric drive unit for day-to-day urban use, no restrictions on speed, hill-climbing ability or trailer loads, and substantial potential for reducing CO<sub>2</sub> emissions. The Volkswagen Group is mounting a major push for this technology. Integration into the modular toolkit strategy is a significant element of this. This technology underscores the importance of e-mobility within the Group, giving it a firm, long-term place in its product strategy. Combined drives are already available today in a large number of vehicle classes in the form of the hybrid versions of the Jetta, Touareg, Audi Q5, Audi A6, Audi A8, Porsche Cayenne S and Porsche Panamera S models.

In 2013, we rang in the age of pure-play e-mobility in the Group with the market launch of the e-up! The e-Golf will be launched in spring 2014. The Group brands performed extensive trials, including with customer involvement, with purely electric vehicles and plug-in hybrids in the reporting period and were able to further optimize the technology, its suitability for daily use and user requirements for subsequent series production.

Alongside purely electric vehicles, a range of plug-in hybrid vehicles from many of the Group's brands will be launched around the world in the coming years.

Mass mobility using electric vehicles still faces some challenges, however. In the area of battery chemistry, developing high-performance batteries and building up technological expertise are both vital to increasing the range and hence the attractiveness of electric vehicles. Another challenge is integrating electric cars into the existing infrastructure. Questions still need to be answered with respect to the recharging strategy to be adopted ("smart grid"), how to construct an end-to-end infrastructure, particularly of rapid charging stations, and how to book charging points and bill the electricity provided; these questions must be answered together with governments, municipal authorities and utilities. In our opinion, an intelligent combination of the automotive, power generation and telecommunications sectors offers the opportunity to ease the transition to e-mobility for our customers, or to make it attractive for them. A broad range of new services, such as mobile online services or intelligent recharging, could play an important role in this.

Volkswagen will manufacture not only the bodywork but also the core components of electric cars: the electric motor and the battery system. The motors will be manufactured in the Kassel plant, while the battery modules will be assembled into battery systems at the Braunschweig facility.

Thanks to our conventional and alternative technologies and the modular toolkit strategy, which allows innovations to be incorporated rapidly into different vehicles, the Volkswagen Group is optimally positioned to meet the challenges that the future will bring.

#### REPORT ON POST-BALANCE SHEET DATE EVENTS

There were no significant events after the end of fiscal year 2013.

# Report on Expected Developments

The global economy and many automotive markets are expected to continue growing in 2014. The main driver of the global economy is the rapidly expanding emerging markets. The Volkswagen Group intends to capitalize on this trend by building on the strength of its brand diversity, pioneering technologies and global presence.

In the following, we describe the expected future development of the Volkswagen Group and the general framework for its business activities. Risks and opportunities that represent a departure from the forecast trends are presented in the Report on Risks and Opportunities.

We prepare our forecasts on the basis of current estimates by third-party institutions. These include economic research institutes, banks, multinational organizations and consulting firms.

## GLOBAL ECONOMIC DEVELOPMENT

Our plans assume that the global economy will grow slightly faster in 2014 than in the reporting period. Going forward, we anticipate that growth will remain strongest in the emerging economies of Asia. While we expect to see signs of recovery in the economies of the major industrialized nations, the rates of expansion will remain moderate in the medium term.

We believe that the global economy will continue growing in the period 2015 to 2018.

### Europe/Remaining markets

In Western Europe, we are forecasting a consolidation in 2014 of the economic recovery that began in the reporting period. However, developments remain contingent on structural problems being resolved, especially in Southern Europe.

In Central and Eastern European countries, on the other hand, whose economies are heavily dependent on the economic situation in Western Europe, we believe that significantly faster growth on a level with the previous year is likely. We expect the Russian economy to record a slightly higher rate of expansion than in 2013.

In 2014, the South African economy will continue to suffer the effects of political uncertainty and social tensions resulting primarily from high unemployment levels, though the pace of growth should accelerate somewhat once again.

### Germany

We believe that the uptrend in Germany will be sustained in 2014 with rising growth rates. The situation in the labor market is also expected to remain positive.

### North America

We expect economic activity in North America to continue to pick up in 2014. In our view, growth in the USA, Canada and Mexico will strengthen compared with the prior year.

### South America

In Brazil, we anticipate that growth rates in 2014 will be on a level with the prior year. Argentina's economy is expected to continue growing, albeit at a slower pace and with persistently high inflation, which is weighing on the business climate.

### Asia-Pacific

Growth in China will remain at a high level and in 2014 is again expected to reach the target set by the government. In India, we estimate that the pace of expansion will remain moderate following recent below-average growth. The Japanese economy is likely to continue growing on a level with the previous year on the back of the expansionary monetary policy.

#### TRENDS IN THE PASSENGER CAR MARKETS

In 2014, we expect to see mixed trends in the passenger car markets in the individual regions. Overall, the increase in global demand for new vehicles will probably be somewhat slower than in the reporting period.

The Volkswagen Group is well positioned to deal with the mixed developments in the automotive markets. Our broad product range featuring the latest generation of consumption-optimized engines gives us a global competitive advantage. We are pursuing the goal of offering all customers the mobility and innovation they need, sustainably strengthening our competitive position in the process.

We estimate that the demand for passenger cars worldwide will continue to increase in the period 2015 to 2018.

#### Europe/Remaining markets

In Western Europe, we expect demand for automobiles to start rising again in 2014 after four years of decline. However, as the ongoing debt crisis is still unsettling consumers in many countries in the region and restricting their financial opportunities to buy new cars, we anticipate only modest growth. Particularly in core markets such as Spain and Italy, large-scale government austerity measures are also putting a damper on demand.

In Central and Eastern European markets, we expect a moderate increase in demand for automobiles in 2014 as against the prior-year level. The Russian market, which dominates this region, will be unable to compensate for the weaker 2013 demand in the short term and will see only a limited recovery in 2014.

We anticipate that the South African vehicle market will grow at a slightly slower pace in 2014 than in the previous year.

#### Germany

After recording initial losses, the German automobile market increasingly stabilized in the course of 2013. This trend is likely to continue in 2014, leading to modest market growth.

#### North America

Although the uncertainty regarding US fiscal policy in the final months of 2013 had an adverse effect on consumer confidence, the market continues to benefit from pent-up replacement demand, a trend we believe will endure in a weaker form in 2014. We estimate that demand in the Canadian market for passenger cars will be on a level with the previous year, but are expecting to see a positive trend in the Mexican passenger car market in 2014.

#### South America

Owing to their dependence on demand for raw materials, the South American markets are heavily influenced by developments in the global economy. Furthermore, increasingly protectionist tendencies are adversely affecting the performance of the region's vehicle

markets, especially in Brazil and Argentina, which have imposed restrictions on vehicle imports. In Brazil, the largest market in South America, demand for vehicles in 2013 was unable to keep pace with the high prior-year level in spite of tax breaks being extended. For 2014, when the tax breaks are expected to be extended, we are forecasting that the market volume will be only marginally higher than in the previous year. In view of the persistently high inflation and the challenging macroeconomic situation, we anticipate that the Argentinian market will contract sharply in 2014.

#### Asia-Pacific

The markets in the Asia-Pacific region look set to continue growing in 2014, albeit at a slower pace. Increasing demand for individual mobility will drive demand in China in particular. After a weak year in 2013, India is likely to see volume growth mirroring the prior-year level, though this will depend on the general business environment. On the strength of the encouraging trend in the Japanese economy, in 2013 the local vehicle market sustained its prior-year level, when the market had been boosted by incentive programs and backlog effects. A previously announced tax increase led to pull-forward effects in the reporting period, as a result of which the overall market will probably decline significantly in 2014.

The markets in the ASEAN region are expected to continue their growth trajectory in 2014.

#### TRENDS IN THE MARKETS FOR COMMERCIAL VEHICLES

The markets for light commercial vehicles will also see mixed trends in the individual regions in 2014. Overall, we envisage slight growth in demand for light commercial vehicles in the markets that are relevant for the Volkswagen Group, and this will continue in the period 2015 to 2018.

Based on the easing of the economic situation in Western Europe expected in 2014, there should be a modest recovery in demand for commercial vehicles in many markets.

We believe that Central and Eastern European markets will perform better in 2014 than in the previous year. In Russia, demand will improve somewhat on the level recorded in 2013.

The North American market for light commercial vehicles will continue to grow in 2014.

In South America, owing to inflation and rising debt, we estimate that demand in 2014 will only marginally exceed the prior-year figure. The expansion of the market for light commercial vehicles is being driven primarily by the growing popularity of SUVs for private use, which are reported as light commercial vehicles in these markets. In addition, continuing protectionist trends are still having a negative impact on market growth, especially in Brazil and Argentina, which have imposed restrictions on vehicle imports. In Brazil, rising interest rates and low consumer confidence are



adversely affecting the market, even though the tax breaks for new vehicle purchases are expected to remain in place for the time being. The Argentinian market is expected to experience only marginal growth in 2014 as a consequence of the macroeconomic situation.

The Asia-Pacific region looks set to see slight growth in 2014. We expect the market volume in China to be up slightly year-on-year. Provided that the economic environment stabilizes in India, an end to the downward trend is likely in 2014 following a weaker 2013. Japan benefited in the reporting period from the expansionary economic policy. We expect that the market volume for light commercial vehicles in Japan in 2014 will be down slightly on the prior year.

For the majority of the Asian automotive markets, including the ASEAN markets, we are forecasting further growth starting in 2014.

Demand for mid-sized and heavy trucks rose slightly in 2013, and we are also forecasting a small increase in total volumes in the markets relevant to the Volkswagen Group in 2014, mostly in the second half of the year. We are expecting growth to continue in the period 2015 to 2018.

In Western Europe, the economic situation will improve, but market trends will continue to be determined by the introduction of the new Euro 6 emission standard, which has pulled forward an appreciable proportion of demand to 2013. Thus, we anticipate a reversal of this effect to noticeably depress market levels in 2014.

In Russia, we expect to witness significant growth in demand in 2014. After predominantly weak macroeconomic development in 2013, this is expected to perform more positively in 2014. We are anticipating a rise in truck sales, although changes to the details of the recycling fee may impact this considerably.

Despite the uncertain business climate, demand for trucks in the USA is expected to rise appreciably in 2014.

We are forecasting a small increase in demand in 2014 in the Brazilian market on the back of higher demand for replacement purchases and additional state-sponsored investment and financing programs, while economic growth is expected to remain merely moderate.

The market volume in China, the world's largest truck market, is likely to be sharply below the prior-year level in 2014. This is primarily due to the pull-forward effects in 2013 from the amended emission standards and the government's infrastructure measures that are being gradually phased out and may lead to largely saturated demand for replacement vehicles in 2014. In India, we expect that the market will perform significantly better than in the previous year.

Demand for buses is set to noticeably exceed 2013 levels in almost all regions in 2014, buoyed by increasing urbanization and the growing need for coaches. We expect the bus market in Western Europe to be stable in 2014 and are also forecasting a slight uptrend for China, the largest bus market.

For the period 2015 to 2018, we estimate that demand for buses worldwide will continue to increase overall.

#### TRENDS IN THE MARKETS FOR POWER ENGINEERING

The individual markets in the power engineering segment will again develop at different rates in 2014.

In the merchant shipbuilding market, we expect order volumes to remain at the level of the previous year on account of the continuing overcapacity. Energy efficiency and pollution control will largely determine the future of ship design. We also anticipate strong sales of special ships in 2014, including ships for offshore applications, LNG tankers, cruise ships and government vessels.

Growth in the power generation market will be determined by macroeconomic developments, especially in the emerging economies, where we anticipate a further slight recovery in 2014. In addition to global population growth, the burgeoning demand for energy and the trend towards more decentralized energy supplies are among the main factors. Natural gas-fired power plants will play an increasingly important role. There is also potential to be tapped in the growing demand for combined heat and power (CHP) plants and the need to stabilize the networks using peaking power plants, especially in connection with the increased use of renewable energies.

In the processing industry, we do not anticipate any improvement in the general environment in 2014. Despite high long-term demand for primary materials, the number of new contracts awarded will hover around the prior-year level. The price pressure will continue unabated.

The market outlook in the oil and gas industry is encouraging. We are seeing heavy investment in the exploitation of new deep sea oil reserves and pumping technology. The trend towards using natural gas as an alternative to oil is generally having a positive effect in all key regions. We therefore anticipate slight growth in the oil and gas industry in 2014.

The future in the offshore wind market in Germany is fraught with uncertainty. A positive outlook is not expected until the infrastructural and political framework has been clarified, something that is unlikely to happen in 2014. Going forward, sales opportunities could arise in other regions of the world as well.

We expect that the markets for power engineering will continue to record an increase in overall demand in the period 2015 to 2018.

#### DEMAND FOR FINANCIAL SERVICES

We expect automotive financial services to continue to grow in importance worldwide in 2014. We anticipate that demand for financial services will increase more strongly in those emerging markets in which market penetration is currently low, such as China. In regions with developed automotive finance markets, there will be a further shift in the offering towards enabling mobility at a manageable total cost, with integrated end-to-end solutions, comprising service modules such as insurance and innovative packages of services, and new mobility offerings like carsharing becoming increasingly important. We expect this trend to continue in the period 2015 to 2018.

We estimate that demand for financial services in the mid-sized and heavy commercial vehicles segment will gain momentum in the emerging economies, where financing solutions to support vehicle sales are an essential component of the sales process. In the developed markets, we believe that there will be greater demand for cost-optimized services for mid-sized and heavy trucks in 2014, a trend that will also continue in the period 2015 to 2018.

#### EXCHANGE RATE TRENDS

The global economy lost some of its momentum in 2013. The US Federal Reserve's announcement of its plan to trim its bond-buying program in the near future led to an increased outflow of capital, primarily in countries with high-yielding currencies. This in turn substantially impacted exchange rates, leading to considerable volatility. The euro gained against the US dollar in the first four weeks of 2013 before weakening once more up to July. It then trended upwards again for the remainder of the year. For 2014, we expect euro exchange rates against the US dollar, sterling, Chinese renminbi and other key currencies to be relatively stable, despite continuing high volatility in the financial markets. However, there is still an event risk – defined as the risk arising from unforeseen market developments. We currently assume that this trend will continue in the period 2015 to 2018.

#### INTEREST RATE TRENDS

Interest rates remained extremely low in fiscal 2013 due to the ongoing expansionary monetary policy and the difficult overall economic environment. A number of countries actually cut their interest rates further in the course of the year. In 2014, we consider it unlikely that either Europe or the USA will adopt a more restrictive monetary policy, and hence increase interest rates. We are predicting that short- and long-term interest rates will only rise significantly if there is a sharp increase in inflation. For the period 2015 to 2018, we are predicting a gradual rise in interest rates.

#### COMMODITY PRICE TRENDS

Commodity prices fell in 2013. After peaks were recorded in the first quarter, prices tailed off as the year went on, principally due to the weaker economic signals from China and to supply overcharges. Assuming that the global economy continues to grow, we expect prices of most exchange-traded raw materials in 2014 to fluctuate around the current level. Provided there is a further recovery of the global economy, we believe that commodity prices will rise in the period 2015 to 2018.

#### NEW MODELS IN 2014

We will systematically press ahead with our model initiative in 2014 and modernize and expand our offering by introducing attractive new vehicles. Priority will always be given to what our customers want. We are also successively expanding our portfolio of vehicles equipped with alternative drive systems powered by gas or electricity.

Following on the heels of the e-up!, our first production vehicle to run on electrical power that we launched in 2013, we will also introduce the Golf GTE with a plug-in hybrid drive in 2014 to complement the e-Golf, the electric version of our bestseller. Furthermore, the Volkswagen Passenger Cars brand will enlarge the Golf family by adding the Golf Sportsvan, the successor to the Golf Plus. In addition, the brand will unveil the new generation of the Passat saloon and the Passat estate.

In 2014, the Audi brand will launch the sporty derivative versions S1, S3 saloon, A3 and S3 Cabriolet, as well as the new TT Coupe. Many models, including the A8 hybrid, will also be extensively upgraded. Audi's first plug-in hybrid will be available in 2014 as the A3 e-tron.

ŠKODA is expanding the new generation of its Octavia family with the addition of the Scout and the natural gas-powered edition of the Octavia. The new edition of the Fabia – both as a hatchback and as the Fabia Combi – will score points with its new, contemporary design and once again set standards in its class with its spaciousness.

From 2014, the SEAT brand will offer the efficient CNG models of the Leon and the Leon ST.

In 2014, Porsche will roll out its fifth series with the Macan, the brand's second SUV beneath the Cayenne. In addition to the entry-level version, the Macan will come in S, Diesel S and Turbo versions. We will expand the 911 series by adding the GT3 RS plus a Targa version. Other highlights for 2014 are the GTS versions of the Cayman and the Boxster, as well as the revamped Cayenne and Panamera series. The Cayenne S Hybrid will be upgraded.

Bentley will launch four dynamic models in 2014: the Flying Spur V8, the Continental GT V8 S, the Continental GTC V8 S Convertible and the Mulsanne Speed.

Super sports car manufacturer Lamborghini will introduce its successor to the Gallardo Coupé in 2014, the Huracán, featuring a carbon fiber and aluminum body as well as a new, efficient petrol injection system.

#### PLANNED PRODUCT MEASURES

The Volkswagen Group's goal is to offer consistently efficient and carbon-optimized mobility, including options based on alternative drive technologies, so as to live up to its responsibilities with respect to sustainability. Given the increasingly strict exhaust and emission standards and the fact that vehicle taxation is CO<sub>2</sub>-dependent, vehicle CO<sub>2</sub> emissions are playing a more and more important role in vehicle purchases. Volkswagen is therefore continuing to focus in depth on developing efficient drive technologies, thus extending its position as an innovation leader in the area of environmentally friendly mobility.

We shall continue to drive forward the issues of downsizing and zero emissions in our products in the coming years. Downsizing increases material and energy efficiency by reducing drivetrain sizes while retaining their original performance. We are expanding our e-mobility operations – in the form of both plug-in hybrids and purely electric drives – on the basis of our in-depth research. Our current and future projects are improving the Volkswagen Group's environmental footprint on an ongoing basis.

The Volkswagen Group's many different concepts underscore the individual brands' high level of development and diversification expertise. At the beginning of 2012, the Group became the first manufacturer to implement fuel-saving technology in series production of a charged four-cylinder engine with its cylinder management concept. The Volkswagen Passenger Cars brand has consolidated its holistic ecological sustainability policy in its "Think Blue." concept. This not only combines innovative technology and solutions such as the BlueMotion technologies, but also offers recommendations for reducing emissions and consumption, such as tips and training on how to save fuel. In addition to the BlueMotion vehicles, highly efficient technologies such as the BlueTDI and TSI EcoFuel drives (CNG) set standards for consumption and CO<sub>2</sub> emissions. They leverage innovations such as hybrid/electric drives, start-stop systems and brake energy

recuperation. Other Group brands such as ŠKODA's GreenLine model range and SEAT's ECOMOTIVE models also make use of this technology. Audi offers efficiency technologies as standard. This brand is also developing products such as the fully electronic e-tron vehicles and the natural gas-powered A3 g-tron, which are based on sustainable supply concepts.

#### STRATEGIC SALES FOCUS

The multibrand structure, comprising largely independent brands that nevertheless achieve maximum synergies, is one of the defining features of the Volkswagen Group. The structures that have been put in place have been designed for managing a multibrand organization.

To facilitate the entry into new markets for other Group brands, we will further expand our multibrand structure in the growth markets in particular. We will also sharpen our customer focus across all sales levels and in customer service, for which we are continually enhancing employee qualifications in addition to optimizing our processes and systems to reflect changing customer demands and markets. The focus of our sales strategy remains the same – the integrated marketing of new and used vehicles, financial and other services, as well as genuine parts and accessories.

#### BUILDING A FIRST-CLASS TEAM

Only a top team can deliver the excellence that is necessary for Volkswagen to become number one in international automotive production, which is why, more than ever, we will nurture talented individuals in all areas of the Group.

Our goal for the next few years is to increase our employees' already high level of expertise and problem-solving skills. Vocational training and a university degree are the basis for professional development in the vocational groups at Volkswagen. Employees then obtain further qualifications throughout their working lives. An important pillar of this strategy is the transfer of knowledge and experience by experts to other staff. Qualifications are provided in the form of dual vocational training and classroom education and closely integrate theoretical and practical forms of learning.

INVESTMENT- AND FINANCIAL PLANNING 2014 to 2018 IN THE AUTOMOTIVE DIVISION  
€ billion

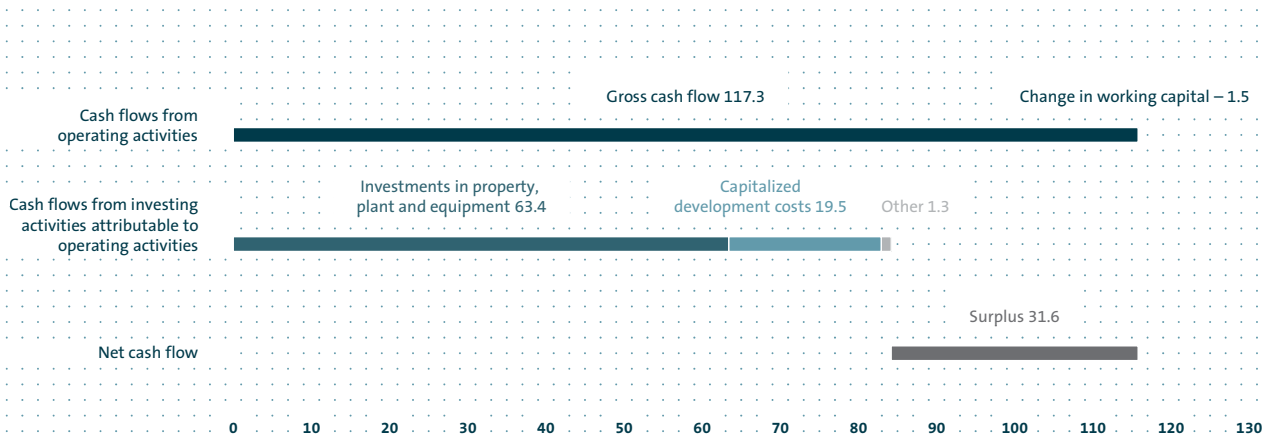

INVESTMENT- AND FINANCIAL PLANNING

Based on our current planning, we shall invest a total of €84.2 billion in the Automotive Division in the period from 2014 to 2018. Investments in property, plant and equipment will account for €63.4 billion, more than half of which (roughly 60%) will be in Germany alone. The ratio of investments in property, plant and equipment (capex) to sales revenue in the period from 2014 to 2018 will be at a competitive level of 6 – 7%. Besides investments in property, plant and equipment, investing activities will include additions of €19.5 billion to capitalized development costs. By investing in new facilities and models, as well as by developing alternative drives and modular toolkits, Volkswagen is laying the foundations for profitable, sustainable growth. These investments also include commitments arising from decisions taken in previous fiscal years.

At €41.2 billion (roughly 65%), the lion's share of the total amount to be invested in property, plant and equipment in the Automotive Division will be spent on modernizing and extending the product range for our brands.

Among other things, the high level of investment results from upfront expenditures in connection with the Euro 6 emission standard, which necessitates extensive upgrading of the vehicle and engine portfolio. The main focus will be on new vehicles and successor models in almost all vehicle classes, which will be based on the modular toolkit technology and the related components. This will allow us to systematically continue our model rollout with a view to tapping new markets and segments. In the area of drivetrain production, we will launch new generations of engines offering improved performance and lower fuel consumption and emission levels, focusing for example on hybrid and electric motors.

In addition, Volkswagen will make cross-product investments of €22.2 billion over the next five years; this includes investments to expand capacity. As a result of our high quality targets and our commitment to continuous improvement of our production processes, investments in our press shops and paintshops are also necessary. Non-production-related investments are mainly planned for the areas of development, quality assurance, sales, genuine parts supply and information technology.

We endeavor to finance our investments in the Automotive Division using internally generated funds and expect cash flows from operating activities to amount to €115.8 billion over the 2014 to 2018 planning period. This means that the funds generated are expected to exceed the Automotive Division's investment requirements by €31.6 billion, further improving our liquidity position. We expect net cash flow in the Automotive Division to be moderately lower in 2014 than in the prior year, but it will nevertheless make a significant contribution to strengthening the Group's financial position.

These plans are based on the Volkswagen Group's current structures. They do not take into account the possible settlement payable to other shareholders associated with the control and profit and loss transfer agreement with MAN SE. Our joint ventures in China are not consolidated and are therefore also not included in the above figures. These joint ventures will invest a total of €18.2 billion in new production facilities and products in the period from 2014 to 2018 and will finance these investments from the companies' own funds.

We are planning to invest €2.6 billion in the Financial Services Division from 2014 to 2018. We expect the growth in leasing and rental assets and in receivables from leasing, customer and dealer

financing to lead to funds tied up in working capital of €81.8 billion. Roughly 43% of the total capital requirements of €84.5 billion will be financed from gross cash flow. As is common in the sector, the remaining funds needed will be met primarily through established money and capital market debt issuance programs and customer deposits from the direct banking business.

#### TARGETS FOR VALUE-BASED MANAGEMENT

Based on long-term interest rates derived from the capital market and the target capital structure (fair value of equity to debt = 2:1), the minimum required rate of return on invested capital defined for the Automotive Division remains unchanged at 9%. We again clearly exceeded the minimum required rate of return in the reporting period, at 14.5% (see also pages 104 and 108). An increase in invested capital as a result of the largest volume of investments in the Group's history will have a dampening effect on future returns. Nevertheless, we expect that our return will continue to be in excess of the minimum required rate of return. Under our Strategy 2018, our medium-term goal is a sustained return on investment of more than 16% in the Automotive Division, which is significantly above the minimum required rate of return.

This report contains forward-looking statements on the business development of the Volkswagen Group. These statements are based on assumptions relating to the development of the economic and legal environment in individual countries and economic regions, and in particular for the automotive industry, which we have made on the basis of the information available to us and which we consider to be realistic at the time of going to press. The estimates given entail a degree of risk, and the actual developments may differ from those forecast. Consequently, any unexpected fall in demand or economic

stagnation in our key sales markets, such as Western Europe (and especially Germany), the USA, Brazil, China, or Russia will have a corresponding impact on the development of our business. The same applies in the event of a significant shift in current exchange rates, mostly against the euro and primarily in US dollars, sterling, Chinese renminbi, Swiss francs, Mexican pesos, Swedish kronor, Polish zloty and Australian dollars. In addition, expected business developments may vary if this report's assessments develop in a way other than we are currently expecting.

#### SUMMARY OF EXPECTED DEVELOPMENTS

The Volkswagen Group's Board of Management expects the global economy to record slightly stronger growth in 2014 than in the previous year, despite some uncertainties. The financial markets still entail risks resulting above all from the strained debt situation of many countries. While the industrialized nations will probably record moderate rates of expansion, we continue to anticipate that growth will be strongest in the emerging economies of Asia.

The automotive industry remains dependent on global economic developments. We expect that competition in the international automotive markets will continue to increase. The markets in which the Group's brands operate remain challenging, particularly in Western Europe.

In 2014, we expect trends in the passenger car markets in the individual regions to be mixed. Overall, growth in global demand for new vehicles will probably be somewhat slower than in the reporting period. We anticipate a slight recovery in demand for automobiles in Western Europe, and volumes in the German market are also likely to increase again somewhat in 2014. The passenger car markets in Central and Eastern Europe will only just exceed the prior-year level. The upward trend in North America will probably weaken, while the South American passenger car markets will be on a level with the previous year. We anticipate further growth in 2014 for the markets in the Asia-Pacific region that are strategically important for the Volkswagen Group, although momentum there is expected to be lower than in the previous year.

The global markets for light commercial vehicles will probably experience slight growth overall in 2014, with the individual regions recording mixed trends.

We anticipate that the overall volume in the markets for trucks and buses that are relevant for the Volkswagen Group will see a slight increase in 2014 as against the previous year, with the greatest growth expected in the second half of the year.

We expect demand for automotive financial services to grow worldwide again in 2014.

The Volkswagen Group is well positioned to deal with the mixed developments in the automotive markets. Our strengths include our unique brand portfolio covering almost all segments, from motorcycles through subcompact cars to heavy trucks and buses, our steadily growing presence in all major markets in the world and our wide range of financial services. We offer an extensive range of environmentally friendly, cutting-edge, high-quality vehicles for all markets and customer groups that is unparalleled in the industry. The Volkswagen Group will press ahead with its product initiative across all brands in 2014, and we will modernize and expand our

offering by introducing attractive new vehicles. We are pursuing the goal of offering all customers the mobility and innovation they need, sustainably strengthening our competitive position in the process.

We expect that the Volkswagen Group will moderately increase deliveries to customers year-on-year in 2014 in a still challenging market environment. The new production facilities at our Chinese joint ventures will make a significant contribution to this development. We will also sharpen our customer focus across all sales levels and in customer service.

Challenges for the Volkswagen Group will come from the difficult market environment and fierce competition, as well as interest rate and exchange rate volatility and fluctuations in raw materials prices. The modular toolkit system, which we are continuously expanding, will have an increasingly positive effect on the Group's cost structure.

Depending on the economic conditions, we expect 2014 sales revenue for the Volkswagen Group and its business areas to move within a range of 3% around the prior-year figure.

In terms of the Group's operating profit, we are expecting an operating return on sales of between 5.5% and 6.5% in 2014, in light of the challenging economic environment, and the same range for the Passenger Cars Business Area. The Commercial Vehicles/Power Engineering Business Area is likely to moderately exceed the 2013 figure. The operating return on sales in the Financial Services Division is expected to be between 8.0% and 9.0%. We are aiming to achieve a sustainable return on sales before tax at Group level of at least 8% by 2018 at the latest.

In the Automotive Division, the ratio of capital expenditure to sales revenue will fluctuate around a competitive level of 6 – 7% in 2014. The return on investment (RoI) will be below the prior-year level due to the extensive investment program, but still well above our minimum required rate of return of 9%. Net cash flow will probably be moderately lower than in the previous year, but will nevertheless make a significant contribution to strengthening the Group's finances. Our goal is also to maintain our positive rating compared with the industry as a whole and to continue our solid liquidity policy.

We are working to make even more focused use of the strengths of our multibrand group by constructing new plants and developing new technologies and toolkits. We will successfully meet the challenges of today and tomorrow thanks to a first-rate team, which delivers excellence and ensures the quality of our innovations and products at the highest level. Disciplined cost and investment management and the continuous optimization of our processes remain integral elements of the Volkswagen Group's Strategy 2018.

# Report on Risks and Opportunities

(CONTAINS THE REPORT IN ACCORDANCE WITH SECTION 289(5) OF THE HGB)

Our Company's long-term success also depends on how promptly we identify the risks and opportunities arising from our operating activities and how forward-looking we are in managing them. A comprehensive risk management and internal control system helps the Volkswagen Group deal with risks in a responsible manner.

In this chapter, we first explain the objective and structure of the Volkswagen Group's risk management system (RMS) and internal control system (ICS) and describe the system relevant for the financial reporting process. We then outline the risks and opportunities arising in our business activities.

## OBJECTIVE OF THE RISK MANAGEMENT SYSTEM AND INTERNAL CONTROL SYSTEM AT VOLKSWAGEN

Only by promptly identifying, accurately assessing and effectively managing the risks and opportunities arising from our business activities can we ensure the Volkswagen Group's sustainable success and the systematic implementation of our Strategy 2018. The Volkswagen Group's RMS/ICS aims to identify potential risks at an early stage so that suitable countermeasures can be taken to avert the threat of loss to the Company, and any risks that might jeopardize its continued existence can be ruled out.

Uniform Group principles are used as the basis for managing risks in a transparent and appropriate manner. These include

- > promoting a culture of openness with regard to risks
- > aligning the RMS/ICS with corporate goals
- > weighing up risks and opportunities so as to be able to leverage opportunities where the related risks are transparent and manageable
- > complying with rules (compliance, see also page 57)
- > ensuring the adequacy of the RMS/ICS in relation to the nature, scope and complexity of, as well as the risks involved in, the specific business activities and the business environment
- > regularly reviewing the effectiveness and efficiency of the RMS/ICS.

## STRUCTURE OF THE RISK MANAGEMENT SYSTEM AND INTERNAL CONTROL SYSTEM AT VOLKSWAGEN

The organizational design of the Volkswagen Group's RMS/ICS is based on the internationally recognized COSO (Committee of Sponsoring Organizations of the Treadway Commission) framework for enterprise risk management. Volkswagen has chosen a holistic, integrated approach that combines a risk management system, an internal control system and a compliance management system in a single management strategy (governance, risk and compliance strategy). Structuring the RMS/ICS in accordance with the COSO framework for enterprise risk management ensures that potential risks are covered in full; opportunities are not captured.

In addition to fulfilling legal requirements, particularly with regard to the financial reporting process, this approach enables us to manage significant risks to the Group holistically, i.e. by incorporating both tangible and intangible criteria.

Another key element of the RMS/ICS at Volkswagen is the three lines of defence model, a basic element required, among others, by the European Confederation of Institutes of Internal Auditing (ECIIA). In line with this model, the Volkswagen Group's RMS/ICS has three lines of defence that protect the Company from significant risks occurring.

No significant changes were made to the RMS/ICS compared with the previous year.

THE THREE LINES OF DEFENCE MODEL

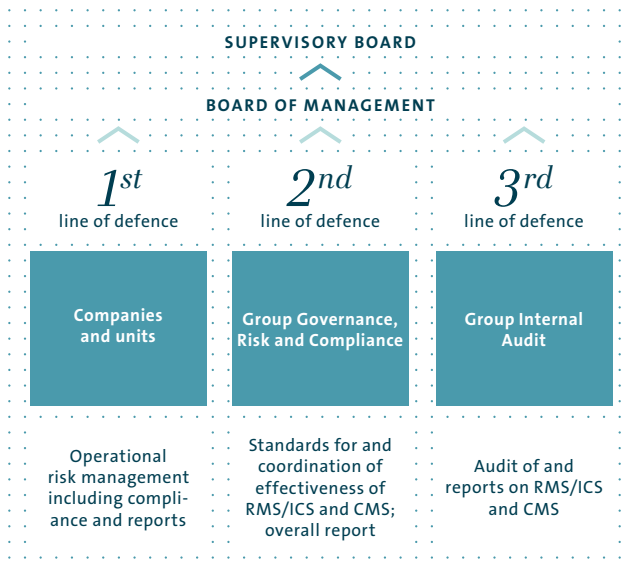

First line of defence: operational risk management

The primary line of defence comprises the operational risk management and internal control systems at the individual Group companies and units. The RMS/ICS is an integral part of the Volkswagen Group's structure and workflows. Events that may give rise to risk are identified and assessed locally in the divisions and at the investees. Countermeasures are introduced immediately, their effects are assessed and the information is incorporated into the planning in a timely manner. The results of the operational risk management process are incorporated into budget planning and financial control on an ongoing basis. The targets agreed in the budget planning rounds are continually reviewed in revolving planning updates.

At the same time, the results of risk mitigation measures that have already been taken are incorporated into the monthly forecasts on further business development in a timely manner. This means that the Board of Management has access to an overall picture of the current risk situation via the documented reporting channels during the year as well.

The minimum requirements for the operational risk management and internal control system are set out for the entire Group in uniform guidelines. These also include a process for the timely reporting of material risks.

Second line of defence: capturing systemic risks using the standard Governance, Risk and Compliance process

In addition to the units' ongoing operational risk management, the Group Governance, Risk and Compliance (GRC) department each

year sends standardized surveys on the risk situation and the effectiveness of the RMS/ICS to the material Group companies and units worldwide (standard GRC process). This feedback is used to update the overall picture of the potential risk situation and assess the effectiveness of the system.

Each material systemic risk is assessed using the expected likelihood of occurrence and various risk criteria (financial and nonfinancial). In addition, the risk management and control measures taken are documented at management level. This means that risks are assessed in the context of any risk management measures, i.e. in a net analysis. In addition to strategic, operational and reporting risks, risks arising from potential compliance violations are also integrated into this process. Moreover, the effectiveness of key risk management and control measures is tested and any weaknesses identified in the process are reported and rectified.

All Group companies and units selected from among the entities in the consolidated Group on the basis of materiality and risk criteria – including Ducati Motor Holding S.p.A., which was consolidated in 2012 – were subject to the standard GRC process in fiscal year 2013. Only the Scania, MAN and Porsche brands were excluded.

The Scania brand, which has been consolidated since July 22, 2008, has not yet been included in the Volkswagen Group's risk management system due to various provisions of Swedish company law. According to Scania's Corporate Governance Report, risk management and risk assessment are integral parts of corporate management. Risk areas are evaluated there by the Controlling department and reflected in the financial reporting.

MAN SE and Dr. Ing. h.c. F. Porsche AG had already implemented their own central processes for capturing risks at the time they were consolidated and are included in the Volkswagen Group's annual reporting.

Third line of defence: checks by Group Internal Audit

Group Internal Audit helps the Board of Management to monitor the various divisions and corporate units within the Group. It regularly checks the risk early warning system and the structure and implementation of the RMS/ICS as part of its independent audit procedures.

RISK EARLY WARNING SYSTEM IN LINE WITH THE KONTRAG

The Company's risk situation is ascertained, assessed and documented in accordance with the requirements of the Gesetz zur Kontrolle und Transparenz im Unternehmensbereich (KonTraG – German Act on Control and Transparency in Business). The requirements for a risk early warning system are met through the elements of the RMS/ICS described above (first and second lines of defence). Separately, the auditors check the processes and procedures implemented for this as well as the adequacy of the documentation on an annual basis. The plausibility and adequacy of the risk reports are examined on a test basis in detailed interviews



ANNUAL STANDARD GOVERNANCE, RISK AND COMPLIANCE PROCESS

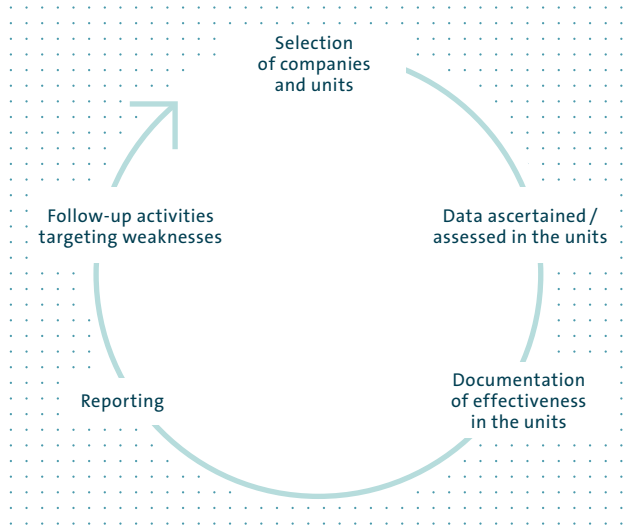

with the divisions and companies concerned that also involve the auditors. The auditors assessed our risk early warning system based on this volume of data and established that the risks identified were presented and communicated accurately. The risk early warning system therefore meets the requirements of the KonTraG.

In addition, the Financial Services Division is subject to scheduled inspections as part of the audit of the annual financial statements and unscheduled inspections within the meaning of section 44 of the Kreditwesengesetz (KWG – German Banking Act) by Bundesanstalt für Finanzdienstleistungsaufsicht (BaFin – the German Federal Financial Supervisory Authority), as well as inspections by the Prüfungsverband deutscher Banken (Auditing Association of German Banks).

Monitoring the effectiveness of the risk management system and the internal control system

The RMS/ICS is regularly optimized as part of our continuous monitoring and improvement processes. In the process, equal consideration is given to both internal and external requirements – such as the provisions of the Bilanzrechtsmodernisierungsgesetz (BilMoG – German Accounting Law Modernization Act). External appraisers assist in the continuous enhancement of our RMS/ICS on a case-by-case basis. The objective of the monitoring and improvements is to ensure the effectiveness of the RMS/ICS. The results culminate in both regular and event-driven reporting to the Board of Management and Supervisory Board of Volkswagen AG.

THE RISK MANAGEMENT AND INTEGRATED INTERNAL CONTROL SYSTEM IN THE CONTEXT OF THE FINANCIAL REPORTING PROCESS

The accounting-related part of the RMS/ICS that is relevant for the financial statements of Volkswagen AG and the Volkswagen Group comprises measures that are intended to ensure the complete, accurate and timely transmission of the information required for the preparation of the financial statements of Volkswagen AG, the consolidated financial statements and the combined Group management report. These measures are designed to minimize the risk of material misstatement in the accounts and in the external reporting.

Main features of the risk management and integrated internal control system relevant for the financial reporting process

The Volkswagen Group's accounting is organized along decentralized lines. For the most part, accounting duties are performed by the consolidated companies themselves or entrusted to the Group's shared service centers. The audited financial statements of Volkswagen AG and its subsidiaries prepared in accordance with IFRSs and the Volkswagen IFRS accounting manual and reported on by the auditors are transmitted to the Group in encrypted form. A standard market product is used for encryption.

The Volkswagen IFRS accounting manual, which is prepared using external expert opinions in certain cases, ensures the application of uniform accounting policies based on the requirements applicable to the parent. In particular, it includes more detailed guidance on the application of legal requirements and industry-specific issues. Components of the reporting packages required to be prepared by the Group companies are also set out in detail there and requirements established regarding the presentation and settlement of intragroup transactions and the balance reconciliation process that builds on this.

Control activities at Group level include analyzing and, if necessary, adjusting the data reported in the financial statements presented by the subsidiaries, taking into account the reports submitted by the auditors and the outcome of the meetings on the financial statements with representatives of the individual companies. These discussions address both the reasonableness of the single-entity financial statements and specific significant issues at the subsidiaries. Alongside reasonableness reviews, control mechanisms applied during the preparation of the single-entity and consolidated financial statements of Volkswagen AG include the clear delineation of areas of responsibility and the application of the dual control principle.

The Group management report is prepared – in accordance with the applicable requirements and regulations – centrally but with the involvement of and in consultation with the Group units and companies.

In addition, the accounting-related internal control system is independently reviewed by Group Internal Audit in Germany and abroad.

#### Integrated consolidation and planning system

The Volkswagen consolidation and corporate management system (VoKUs) enables the Volkswagen Group to consolidate and analyze both Financial Reporting's backward-looking data and Controlling's budget data. VoKUs offers centralized master data management, uniform reporting, an authorization concept and maximum flexibility with regard to changes to the legal environment, providing a future-proof technical platform that benefits Group Financial Reporting and Group Controlling in equal measure. To verify data consistency, VoKUs has a multi-level validation system that primarily checks content plausibility between the balance sheet, the income statement and the notes.

#### RISKS AND OPPORTUNITIES

In this section, we outline the specific risks and opportunities, which we have grouped into categories. Unless explicitly mentioned, there were no material changes to the specific risks and opportunities compared with the previous year.

We use competitive and environmental analyses and market studies to identify not only risks but also opportunities with a positive impact on the design of our products, the efficiency with which they are produced, their success in the market and our cost structure. Risks and opportunities that we expect to occur are already reflected in our medium-term planning and our forecast. The following therefore reports on internal and external developments as risks and opportunities that may result in a negative or positive deviation from our forecast.

#### Macroeconomic risks and opportunities

We currently see risks to continued global economic growth primarily in the persistent structural deficits in developed economies. The unanswered questions surrounding the economic and institutional stability of the eurozone are particularly noteworthy in this context, as are the unresolved debt problem in many industrialized countries. In the eurozone, the situation of numerous financial institutions whose stability and ability to withstand a crisis remain in doubt is hindering sustained economic recovery.

Structural deficits also pose a risk to the growth of many emerging economies. Overindebtedness, reliance on capital

inflows, violent clashes and corruption are some of the main threats to these countries' development going forward.

As the global economy becomes increasingly interconnected, declines in growth in key countries and regions often have an immediate impact on the state of the global economy and therefore pose a central risk. The trend in the large economies of Europe, the USA and China is especially important for global growth.

Geopolitical risks result primarily from tensions in the Middle East and North Africa and may impact negatively on global energy and commodity prices. In addition, a large number of local and regional conflicts pose a threat to the performance of both individual economies and entire regions.

Overall, we consider the probability of a global recession to be low. Due to the risk factors listed, however, the possibility of a decline in global economic growth or a period of below-average growth rates cannot be ruled out.

The macroeconomic environment may also give rise to opportunities for the Volkswagen Group if actual developments differ in a positive way from expected developments.

#### Sector-specific risk and market opportunities

The growth markets of Asia, South America, and Central and Eastern Europe are particularly important for the Volkswagen Group in terms of the global trend in demand for passenger cars and commercial vehicles. Although these markets harbor considerable potential, the underlying conditions in some of the countries in these regions make it difficult to increase unit sales figures there. Some have high customs barriers or minimum local content requirements for domestic production, for example. Following the reduction in the number of new vehicles allowed to be registered in places such as Beijing, further restrictions on registrations could enter into force in other Chinese metropolitan areas as well. Furthermore, a potential global economic slowdown could impact negatively on consumer confidence in some of these countries. Equally, we cannot entirely rule out the possibility of freight deliveries being shifted from trucks to other means of transport and of demand for the Group's commercial vehicles falling as a result.

At the same time, if the economic and regulatory situation permits, there are opportunities for faster growth above and beyond current projections in emerging markets where vehicle ownership rates are still low. The demand that builds up in established markets during a crisis could also lead to a strong recovery in these markets should the economic environment ease more quickly.

Price pressure in established automotive markets is a particular challenge for the Volkswagen Group as a supplier of volume and

premium models due to its high level of market coverage. As the global economy is still under strain, competitive pressures are likely to remain high in the future. Some manufacturers will respond by offering incentives in order to meet their sales targets, putting the entire sector under additional pressure, particularly in Western Europe, the USA and China.

Western Europe is one of our main sales markets. A drop in prices due to the economic climate as demand falls in this region would have a particularly strong impact on the Company's earnings. We counter this risk with a clear, customer-oriented and innovative product and pricing policy. Outside Western Europe, overall delivery volumes are broadly diversified throughout the world. The Chinese market accounts for an increasing share. We either already have a strong presence in numerous existing and developing markets or are working hard to build such a presence. Moreover, strategic partnerships help us to increase our presence in these countries and regions and cater to requirements there.

The global economic climate deteriorated tangibly in fiscal year 2013. The resulting challenges for our trading and sales companies, such as efficient warehouse management and a profitable dealer network, are considerable and are being met by appropriate measures on their part. However, financing business activities through bank loans remains difficult. Our financial services companies offer dealers financing on attractive terms with the aim of strengthening their business models and reducing operational risk. We have installed a comprehensive liquidity risk management system so that we can promptly counteract any liquidity bottlenecks at the dealers' end that could hinder smooth business operations.

We continue to approve loans for vehicle finance on the basis of the same cautious principles applied in the past, taking into account the regulatory requirements of section 25a(1) of the Kreditwesengesetz (KWG – German Banking Act).

Volkswagen may be exposed to increased competition in after-markets for two reasons: firstly, because of the provisions of the new Block Exemption Regulations, which have been in force for after-sales service since June 2010, and, secondly, because of the amendments included in EU Regulation 566/2011 dated June 8, 2011, which expand independent market participants' access to technical information.

The European Commission is planning to end design protection for visible vehicle parts. If this plan is actually implemented, it could adversely affect the Volkswagen Group's genuine parts business.

Below, we outline the market opportunities for the Volkswagen Group. We see the greatest potential for growth in the markets of the Asia-Pacific region and in North America.

#### China

China, the largest market in the Asia-Pacific region, saw further market growth in 2013. Here, demand for vehicles will continue to

increase in the coming years due to the need for individual mobility, although growth will probably shift from the large cities on the coast to the country's interior. To be able to leverage the considerable opportunities offered by this market and defend our strong market position in China over the long term, we are continuously expanding our product range to include models that have been specially developed for this market. We are further expanding our production capacity in this growing market through additional production facilities.

#### India

India achieved a lower market volume in fiscal year 2013 than in the previous year due to the difficult environment. Demand was impacted in particular by high inflation and increased fuel prices. We expect demand to stabilize in the coming years, however. The Group is currently consolidating its activities in this difficult environment. Despite the current situation, India is still a strategically important market of the future for the Group.

#### ASEAN

The automotive markets in the ASEAN economic area offer substantial growth opportunities in the aggregate. The Volkswagen Group is gradually working toward the long-term penetration of these markets. High price sensitivity means that having a local manufacturing operation in the region is a condition for a competitive offering. Alongside with the Passat, we have been additionally producing the Polo hatchback and notchback, plus the Jetta, since 2013. To further strengthen our market position, we are investigating and evaluating opportunities for assembling vehicles locally in additional countries in the region. Independent of this, we are working hard to improve local sales structures.

#### North America

The government crisis in the USA had relatively little impact on the vehicle market in 2013. Despite the political uncertainty, pent-up demand and the availability of auto loans pushed the overall market above the prior-year level in 2013. We anticipate further growth but slower momentum in 2014. In Canada and Mexico, market growth was moderate in 2013; it is expected to continue in 2014. North America remains a growth region for the Volkswagen Group. In the United States, we are systematically pursuing our strategy of becoming a full-fledged volume supplier. Together with an engine plant, the development of additional production capacity in the region to manufacture the Golf and the Audi Q5 will allow us to better serve the market in the future. We are also working hard on offering additional products tailored specifically for the US market, for example a large SUV.

#### Brazil

In 2012, the Brazilian government supported local industry, including the automotive industry, by providing tax breaks. This support was partially withdrawn in January 2013, slowing growth in the automotive market. In the first half of the year, the market trend was also impacted by rising interest rates and an upturn in inflation. To prevent a further decline in the Brazilian market as a whole, the tax breaks will be initially continued in 2014 in a weakened form. The growing number of automobile manufacturers with local production has resulted in a sharp increase in price pressure and competition. The Brazilian market plays a key role for the Volkswagen Group. To strengthen our competitive position here, we offer vehicles that have been specially developed for this market and locally produced, for example the Gol and the Fox.

#### Russia

We continue to expect that Russia has the potential to grow into one of the largest automotive markets in the world. However, its heavy reliance on currently stagnating oil revenues is slowing economic growth. The discontinuation of subsidized loans in 2014 is also depressing demand for vehicles. The market remains of strategic importance for the Volkswagen Group, which is why it is a primary focus of our activities. In addition to the local production in Kaluga, our contract manufacturing agreement with local manufacturer GAZ has added capacity that will enable us to better serve the market. We are also examining additional opportunities to further strengthen our market position.

#### Middle East

Despite economic and political instability, the Middle East region offers growth opportunities. We are leveraging the potential for sustainable growth without operating our own production facilities by offering a range of vehicles that has been specifically tailored to this market. Optimized sales channels are also intended to help lift our market share.

#### Research and development risk

We conduct extensive trend analyses, customer surveys and scouting activities so as to adequately reflect our customers' requirements during product development. In this way, we ensure that we identify trends at an early stage and examine their relevance for our customers in good time.

We counter the risk that it may not be possible to develop products or modules within the specified timeframe, to the required quality standards, or in line with cost specifications by continuously and systematically monitoring the progress of all projects and increasingly analyzing third-party industrial property rights, including in relation to communication technologies. We regularly compare this progress with the project's original targets; in the event of variances, we introduce appropriate counter

measures in good time. Our end-to-end project organization supports effective cooperation among all areas involved in the process, ensuring that specific requirements are incorporated into the development process as early as possible and that their implementation is planned in good time.

#### Opportunities arising from the Modular Transverse Toolkit

The Modular Transverse Toolkit (MQB) and the Modular Production Toolkit (MPB) enable us to cut both development costs and the necessary one-time expenses and manufacturing times as well as to leverage expenditure over several vehicle generations. The toolkits also allow us to produce different models in different quantities and even from different brands using one and the same plant in a single facility. This enables us to deploy our capacity more flexibly across the entire Group and to achieve efficiency gains.

In addition to conventional petrol and diesel engines, the MQB also affords us the opportunity to integrate alternative drivetrains, such as gas, hybrid, or electric drives. Previously, individual, vehicle-specific adaptations were necessary. The MQB has created an extremely flexible vehicle architecture that permits dimensions determined by the concept such as the wheelbase, track width, wheel size and seat position to be harmonized throughout the Group and deployed flexibly. Other dimensions, for example the distance between the pedals and the middle of the front wheels, are always the same and guarantee a uniform system in the front of the car, enabling synergies to be generated.

#### Procurement risks and opportunities

Although European demand for vehicles steadied in the reporting period, there are still considerable economic differences in the regional markets. These are affecting our suppliers, especially those focused on Southern and Western Europe. In 2013, this situation once again contributed to a cautious stance on the part of investors. As a result, greater consideration was given to suppliers' financing options when making lending decisions. The Volkswagen Group's procurement risk management system is well prepared for the current environment: changes at the suppliers' end are continuously monitored and a suite of different measures deployed in the event of any negative developments. This allows us to minimize supply risks and the financial effects of crises and insolvencies at suppliers.

The modular structure of our toolkits make them the ideal starting point for requests for bundled volumes of vehicle parts and for synchronized order and procurement processes. We will systematically enhance this strategy with the Modular Transverse Toolkit in the A0 vehicle class and combine worldwide volumes into a single request. In doing so, we consider both market requirements and conditions at the location, with the objective of a globally harmonized supplier strategy. This process creates the conditions for us to exploit regional and transregional synergies. Furthermore,

start-up risks in the Volkswagen Group are minimized, one-time expenses are optimized and the security of planning and supplies are ensured at a global level.

#### Production risk

The weakness in the European automotive market also had a noticeable effect on production at the Volkswagen Group in 2013. Changes in the demand environment, partly due to weak domestic markets, caused production volumes of several vehicle models to fluctuate at some plants. We have various tools at our disposal with which to smooth out these market-driven fluctuations, such as flexible working time models and dynamic capacity utilization at our sites. “Turntable concepts” are used to keep capacity utilization at our production sites at a consistently high level. In addition, we are better able to smooth out fluctuations in demand at multi-brand sites, the number of which is growing in the Group.

Short-term changes in demand for special equipment features or components of our products and the decreasing predictability of those changes may lead to supply bottlenecks. We minimize this risk, among other things, using a revolving process that examines the feasibility of different future demand scenarios for vehicle features. If there are signs of bottlenecks in the supply of materials, countermeasures can be introduced with sufficient lead time.

Regular preventative maintenance measures ensure that plant availability is high and that output at our production facilities remains stable.

We select new sites for vehicle or drivetrain plants by means of a transparent process that is consistent for all Group brands. In addition to economic, geological and technical factors, environmental factors, environmental laws and compliance requirements are assessed and considered in detail in the course of this process.

#### Risks arising from long-term production

In the case of large projects, risks may arise that are often only identified in the course of the project. These may result in particular from contracting deficiencies, miscosting, post-contract changes in economic and technical conditions, weaknesses in project management and poor performance by subcontractors. We use an enhanced project control process that covers all project phases and a lessons learned process to endeavor to identify such risks at an even earlier stage and to take appropriate measures to eliminate or minimize them before they occur.

#### Risks arising from changes in demand

Consumer demand is shaped not only by real factors such as disposable income, but also by psychological factors that are impossible to plan for.

Increased fuel and energy prices could result in unexpected buyer reluctance, which could be further exacerbated by media reports, for example. This is particularly the case in saturated automotive markets such as Western Europe, where demand could drop as a result of owners holding on to their vehicles for longer. In the reporting period, the effect of unplannable psychological demand factors was exacerbated by the euro crisis and its impact on the global economy and the entire automotive industry. Several automotive markets, particularly in Southern Europe, were unable to recover from their record lows in the reporting period and even contracted further in some cases. We are countering this buyer reluctance with our attractive range of models and in-depth customer orientation.

A combination of buyer reluctance as a result of the crisis and increases in some vehicle taxes based on CO<sub>2</sub> emissions – such as those already formulated in some European countries – is driving a shift in demand towards smaller segments and engines in individual markets. We counter the risk that such a shift will negatively impact the Volkswagen Group’s earnings by constantly developing new, fuel-efficient vehicles and alternative drive technologies, based on our drivetrain and fuel strategy. In automotive markets around the world, risks arise due to government intervention in the form of tax increases, for example, which could curb private consumption.

As industrial goods, commercial vehicles are influenced by the general economic environment, which means that the market is highly cyclical. Although production volumes are significantly lower, the complexity of the trucks and buses range even exceeds that of passenger cars, since they are tailored to the customers’ requirements. The priorities for commercial vehicle customers are overall running costs, vehicle reliability and the service provided.

MAN Power Engineering’s two-stroke engines are produced exclusively by licensees, particularly in China and Korea. Weaker demand could result in licensees having excess capacity and consequently in risks due to declining license revenues or bad debt losses up to and including the loss of licensees. We address the risks by constantly monitoring the markets, carefully managing business relationships with licensees and, if necessary, agreeing payment plans.

#### Dependence on fleet customer business

In fiscal year 2013, the percentage of total registrations in Germany accounted for by fleet customers fell to 12.5% (12.7%). The Volkswagen Group's share of this customer segment decreased to 47.2% (47.7%).

In Europe, the Volkswagen Group was unable to extend its position in this customer segment despite its comprehensive product range and customized support for this target group; registrations by business fleet customers were down 2.2% year-on-year, while the Group's share fell to 28.8% (29.4%). The fleet customer business continues to be marked by increasing concentration and internationalization. With its broad product portfolio, the Group is well positioned to face the growing importance of the issue of CO<sub>2</sub> and the trend towards downsizing. No default risk concentrations exist for individual corporate customers.

#### Quality risk

Right from the product development stage, we aim to identify and rectify quality problems at the earliest possible point so as to prevent potential delays to the start of production. The increasing use of modular components means that, when vehicle defects occur, the cause of the defect must be identified and eliminated as quickly as possible. In the reporting period, we further optimized the process by which defects are rectified in the brands and improved its organization so as to counter the related risks.

Growing production volumes, increasing complexity and the use of the Group's toolkit system mean that the need for high-grade supplier components of impeccable quality is also rising. To ensure production and hence meet customer expectations, it is extremely important that our own plants and our suppliers deliver on time. The introduction of an internally-tested risk management system at suppliers is an important step towards ensuring long-term quality and supply capability early on in the supply chain. In this way, quality assurance helps to fulfill customer expectations and consequently boost our Company's reputation, sales figures and earnings.

Sustained high demand in the Volkswagen Group's key markets also presents particular challenges for quality assurance. Quality assurance is of fundamental importance especially in the growing automotive markets of Brazil, Russia, India and China, for which dedicated vehicles are developed and where local manufacturing operations and suppliers have been established. We analyze the conditions specific to each market and thus ensure growth in these regions. In cooperation with the central quality assurance function, we continuously develop effective measures to counter identified local risks and then implement those measures locally, minimizing quality defects from the outset.

Vehicle registration and operation criteria are set and monitored by national and, in some cases, international authorities. Some countries also have special, and in some cases new, rules aimed at protecting customers in their dealings with vehicle manufacturers. Therefore, we systematically ensure that the Volkswagen Group brands and their products fulfill all applicable requirements and the local authorities receive timely notification of all issues required to be reported. By doing so, we reduce the risk of customer complaints, administrative fines and other negative consequences for Volkswagen.

#### Personnel risk

The individual skills and technical expertise of our employees are a major factor contributing to the Volkswagen Group's success. Our aim of becoming the top employer in the automotive industry improves Volkswagen's chances of recruiting and retaining the most talented employees.

Our strategic, end-to-end human resources development strategy gives all employees attractive training and development opportunities, with particular emphasis placed on increasing technical expertise in the Company's different vocational groups. By continuously expanding our recruitment tools and boosting training programs, particularly at our international locations, we are able to adequately address the challenges posed by growth from a human resources perspective.

In addition to the standard twin-track vocational training, programs such as our StIP integrated degree and traineeship scheme ensure a pipeline of highly qualified and motivated employees. We counter the risk that knowledge will be lost as a result of employee fluctuation and retirement with intensive, department-specific training. We have also expanded our base of senior experts in the Group to ensure that the valuable knowledge of specialists retiring from Volkswagen is transferred to other employees.

Participation and codetermination are factors in the Volkswagen Group's success. Employee involvement and motivation are two sides of the same coin. We aim to maintain a culture of participation at Volkswagen internationally as well. The challenge lies in crafting labor relations with the many trade unions and stakeholder representatives worldwide. We have created a framework for this with our Labor Relations Charter and have pledged our commitment to it.

#### IT risk

At Volkswagen, a global company geared towards further growth, the information technology (IT) used in all divisions Group-wide is assuming an increasingly important role. IT risks include

unauthorized access to sensitive electronic corporate data as well as limited systems availability as a consequence of downtime or natural disasters.

We address the risk of unauthorized access to corporate data by using firewall and intrusion prevention systems and a dual authentication procedure. We achieve additional protection by restricting the allocation of access rights to systems and information and by keeping backup copies of critical data resources. We use technical resources that have been tried and tested in the market, adhering to standards applicable throughout the Company. Redundant IT infrastructures protect us against risks that occur in the event of a systems failure or natural disaster.

In addition, we continuously take measures to combat identified and anticipated risks during the software development process, when protecting the IT infrastructure and also in the allocation of access rights to systems and data resources. These preventative measures are taken with the aim of counteracting the growing intensity and quality of attacks on our IT systems and data resources at an early stage.

Volkswagen supplements its reliable technical protection against unauthorized access to sensitive data by systematically providing its employees with information and training. A Company-wide information security campaign was launched back in 2012, covering topics such as how to handle sensitive data.

#### Environmental protection regulations

The EU Regulation governing CO<sub>2</sub> emissions from passenger cars (443/2009/EC) and the EU Regulation governing light commercial vehicles of up to 3.5 tonnes (510/2011/EU), in effect since April 2009 and June 2011 respectively, set the specific emission limits for all new passenger car and light commercial vehicle models and the fleet targets calculated from the individual vehicle data of brands and groups in the 28 EU member states for the period up to 2019. They are an important component of European climate protection regulations and therefore form the key regulatory framework for product design and marketing by all vehicle manufacturers operating in the European markets.

From 2012 onwards, the average CO<sub>2</sub> emissions of European manufacturers' new passenger car fleets may not exceed the figure of 130 g CO<sub>2</sub>/km. Compliance with this requirement is being introduced in stages: 75% of the fleet had to meet this requirement in 2013, 80% must meet it in 2014 and the entire fleet in 2015. A further significant reduction in European passenger car fleet emissions to 95 g CO<sub>2</sub>/km from 2020 onwards has also been resolved.

The EU's CO<sub>2</sub> regulation for light commercial vehicles requires limits to be met from 2014 onwards, with targets being phased in over the period to 2017: the average CO<sub>2</sub> emissions of new registrations in Europe may not exceed the figure of 175 g CO<sub>2</sub>/km, a target required to be met by 70% of the fleet in 2014. The long-term target has also been set, subject to the European Commission's current review: for the period after 2020, the limit is to be set at 147 g CO<sub>2</sub>/km. Like the CO<sub>2</sub> regulation for passenger

cars, the regulation provides for derogations from the targets, for example by offering relief for eco-innovations.

The European Commission intends to set out the CO<sub>2</sub> regime for the period after 2020 by the end of 2014. Politicians are already discussing reduction targets for the transport sector for the period to 2050, such as the 60% reduction in greenhouse gas emissions from 1990 levels cited in the EU White Paper on transport published in March 2011. It will only be possible to meet these long-term goals by also making extensive use of nonfossil sources of energy, in particular in the form of renewable electricity.

At the same time, CO<sub>2</sub> or fuel consumption regulations are also being developed or introduced outside Europe – in Japan, China, South Korea, India, Brazil, Mexico and Australia, for example. In the USA, a new consumption regulation will impose uniform fuel consumption and greenhouse gas rules in all states of the USA for the period from 2017 to 2025. The law was signed by the US president in mid-2012.

The increase in CO<sub>2</sub> and consumption regulations mean that the latest mobility technologies are required in all key markets worldwide. Electrified and pure-play electric drives will also gain more and more ground.

The Volkswagen Group closely coordinates technology and product planning with its brands so as to avoid breaches of emission limits, which would entail severe sanctions. In principle, the EU legislation permits some flexibility. For example:

- > Excess emissions and emission shortfalls may be offset between vehicle models
- > Emission pools may be formed
- > Relief may be provided in the form of credits that are granted for additional eco-innovations contained in the vehicle and that apply outside the test cycle
- > Special rules are in place for small series producers and niche manufacturers.

Whether the targets are met, however, depends crucially on the Group's technological and financial capabilities, which are reflected, among other things, in our drivetrain and fuel strategy (see page 140).

The other main EU regulations affecting the automotive industry include

- > EU Directive 2009/33/EC on the promotion of clean and energy-efficient road transport vehicles (Green Procurement Directive)
- > EU Directive 2006/40/EC relating to emissions from air-conditioning systems in motor vehicles
- > Passenger car energy consumption labeling directive 1999/94/EC
- > Fuel Quality Directive 2009/30/EC: updates the fuel quality specifications and introduces energy efficiency specifications for fuel production
- > Renewable Energy Directive 2009/28/EC: introduces sustainability criteria
- > Revised Energy Taxation Directive 2003/96/EC: updates the minimum tax rates for all energy products and power.

The implementation of the above-mentioned directives by the EU member states serves as a flanking measure for the CO<sub>2</sub> regulations in Europe. As well as vehicle manufacturers, they are also aimed at other stakeholders such as the mineral oil industry. Vehicle taxes based on CO<sub>2</sub> emissions are having a similar effect; many EU member states have already incorporated CO<sub>2</sub> elements into their rules on vehicle taxation.

Heavy commercial vehicles put into operation from 2014 onwards are already subject to the stricter emission requirements under the Euro 6 standard in accordance with EU Regulation 595/2009/EC. At the same time as the CO<sub>2</sub> legislation for passenger cars and light commercial vehicles, the EU is preparing a further CO<sub>2</sub> regulation for heavy commercial vehicles. Setting one overarching limit for these vehicles – like that in place for passenger cars and light commercial vehicles – is extremely complicated because of the wide range of variants (tractor units with different trailers or bodywork). With the support of the European Automobile Manufacturers' Association (ACEA), the European Commission is currently preparing a simulation-based method that can be used to determine the CO<sub>2</sub> emissions of heavy commercial vehicles of over 7.5 tonnes according to their typical use (short- and long-haul trips, service on construction sites, city buses and coaches). This method is expected to be the basis for the European Commission's concrete regulatory proposals, which are anticipated by the end of 2014 and likely to enter into force in 2017/2018.

Manufacturers of heavy commercial vehicles are urging the adoption of a system for quantifying CO<sub>2</sub> figures that is accessible to everyone and that looks at the vehicle as a whole, and not simply at the engine or the tractor, in order to increase transparency and therefore competition in the market.

As part of its efforts to reduce the CO<sub>2</sub> emissions of heavy commercial vehicles, the European Commission is also planning to revise the provisions regarding the maximum permissible dimensions of trucks (Directive 1996/53/EC, the Weights and Measures Directive). By relaxing the legal length restrictions, it may be possible to design vehicles in an aerodynamic way without losing any loading space. Air resistance falls in a rounded and streamlined design, cutting fuel consumption. Considering the vehicle as a whole could save up to 25% in fuel through the aerodynamic design of cabs and trailers, as well as additional technical innovations (e.g. low rolling resistance tyres, hybridization).

In the Power Engineering segment, the International Maritime Organization (IMO) has implemented the International Convention for the Prevention of Pollution from Ships (MARPOL), which aims to reduce marine pollution and which is phasing in limits on exhaust emissions from marine engines. Emission limits also apply, for example, under EU directive 1997/68/EC and the US EPA (Environmental Protection Agency) marine regulations. As regards stationary equipment, national rules are in place worldwide and have to be applied locally. On December 18, 2008, the World Bank

Group set limits for gas and diesel engines in its "Environmental, Health, and Safety Guidelines for Thermal Power Plants", which are binding if individual countries have adopted no or less strict national requirements. In addition, back in 1979, the United Nations adopted the Convention on Long-range Transboundary Air Pollution, setting limits on total emissions as well as nitrogen oxide limits for the signatory states (including all EU states, other countries in Eastern Europe, the USA and Canada). Enhancements to the product portfolio in the Power Engineering segment are focusing on improving the efficiency of the equipment and systems.

In order to be optimally prepared for the third emissions trading period starting in 2013, we calculated and disclosed the required CO<sub>2</sub> emissions to be reported for our German plants in accordance with the Datenerhebungsverordnung (DEV 2020 – German Data Collection Regulation). We have submitted the appropriate applications for the allocation of certificates to the Deutsche Emissionshandelsstelle (DEHSt – German Emissions Trading Authority) for all our plants. Our other plants in the European Union were also checked in accordance with the relevant national laws in force at those locations and action was taken to ensure that applications were submitted to the relevant national authorities in good time.

The allocation method for emissions certificates changed fundamentally when the third trading period (2013 – 2020) began. As a general rule, all emission allowances for power generators are being sold at auction starting in 2013. For manufacturing industry and certain power generation installations (e.g. combined heat and power installations), a portion of the certificates are allocated free of charge on the basis of benchmarks applicable throughout the EU. The share allocated for free will gradually decrease as the trading period progresses: the remaining quantities of certificates required will have to be bought, and thus paid for, at auction. Furthermore, installation operators can partly fulfill their obligation to hold emission allowances using certificates from climate protection projects (Joint Implementation and Clean Development Mechanism projects).

For certain (sub-) sectors of industry where there is a risk that production will be transferred to countries outside Europe due to the amended provisions governing emissions trading (a phenomenon referred to as "carbon leakage"), a consistent quantity of certificates will be allocated free of charge for the period from 2013 to 2020 on the basis of the pan-EU benchmarks. The automotive industry is not on this list because in the past it did not meet the criteria examined. It is currently unclear whether it will be included in the carbon leakage list when this is updated in the future.

In 2013, the European Commission decided to initially withhold a portion of the certificates to be auctioned and to only release them for auction at a later date during the third trading period ("backloading"). This temporary shortage of certificates during the trading period may cause certificate prices to rise.



As well as the European Union, other countries in which the Volkswagen Group has production sites are also considering introducing an emissions trading system. Seven pilot projects have started in China, for example, although they have not so far affected the Volkswagen Group. The Chinese government plans to expand those pilot projects into a national emissions trading system.

#### Litigation

In the course of their operating activities, Volkswagen AG and the companies in which it is directly or indirectly invested become involved in legal disputes and official proceedings in Germany and internationally. In particular, such legal disputes and proceedings may occur in relation to suppliers, dealers, customers, employees, or investors. For the companies involved, these may result in payment or other obligations. Particularly in cases where US customers assert claims for vehicle defects individually or by way of a class action, highly cost-intensive measures may have to be taken and substantial compensation or punitive damages paid. Corresponding risks also result from US patent infringement proceedings.

Where transparent and economically viable, adequate insurance cover is taken out for these risks and appropriate provisions recognized for the remaining identifiable risks. The Company does not believe, therefore, that these risks will have a sustained effect on the economic position of the Group. However, as some risks cannot be assessed or can only be assessed to a limited extent, the possibility of loss or damage not being covered by the insured amounts and provisions cannot be ruled out.

ARFB Anlegerschutz UG (haftungsbeschränkt), Berlin, brought an action against Porsche Automobil Holding SE, Stuttgart, and Volkswagen AG for claims for damages allegedly assigned to it in the amount of approximately €1.8 billion. The plaintiff asserts that these claims are based on alleged breaches by the defendants of legislation to protect the capital markets in connection with Porsche's acquisition of Volkswagen shares in 2008. In various cases since 2010, investors initiated conciliation proceedings for other alleged damages – including claims against Volkswagen AG – that amounted to approximately €4.6 billion in total and also related to transactions at that time. In each case, Volkswagen rejected the claims asserted and refused to participate in any conciliation proceedings.

In 2011, the European Commission opened antitrust proceedings against European truck manufacturers including MAN and Scania. The investigations continued in fiscal year 2013. At the reporting date, it is still too early to judge whether these investigations pose any risk to Volkswagen Group companies. Antitrust proceedings, also opened in 2011, by the Korea Fair Trade Commission (KFTC) against several truck manufacturers including MAN and Scania were brought to a close in fiscal year 2013 with decisions to impose administrative fines on all manufacturers involved. MAN and Scania are currently examining legal action against the decision to impose fines.

MAN has also launched an investigation into the extent to which irregularities occurred in the course of the handover of four-stroke marine diesel engines, and in particular whether technically calculated fuel consumption figures were externally manipulated. MAN informed the Munich Public Prosecution Office (I) about the ongoing investigation and the matter was handed to the Augsburg Public Prosecution Office. In this connection, the Augsburg Local Court imposed an administrative fine in the single-digit millions on MAN Diesel & Turbo SE. The investigations by the Augsburg Public Prosecution Office into MAN Diesel & Turbo SE were terminated on payment of this amount.

The Annual General Meeting of MAN SE approved the conclusion of a control and profit and loss transfer agreement between MAN SE and Truck & Bus GmbH, a subsidiary of Volkswagen AG, in June 2013. In July 2013, award proceedings were instituted to review the appropriateness of the cash settlement set out in the agreement in accordance with section 305 of the Aktiengesetz (AktG – German Stock Corporation Act) and the cash compensation in accordance with section 304 of the AktG. It is not uncommon for noncontrolling interest shareholders to institute such proceedings. Volkswagen continues to maintain that the results of the valuation are correct. The appropriateness of the valuation was confirmed by the audit firms engaged by the parties and by the court-appointed auditor of the agreement.

Suzuki Motor Corporation has filed an action against Volkswagen AG at a London court of arbitration for retransfer of the 19.9% interest held in Suzuki, and for damages. Volkswagen considers the claims to be unfounded and has itself filed counterclaims. The court of arbitration is expected to reach a decision in 2014.

#### Strategies for hedging financial risks

In the course of our business activities, financial risks may arise from changes in interest rates, exchange rates, raw materials prices, or share and fund prices. Management of financial and liquidity risks is the responsibility of the central Group Treasury department, which minimizes these risks using nonderivative and derivative financial instruments. The Board of Management is informed of the current risk situation at regular intervals.

We hedge interest rate risk, where appropriate in combination with currency risk, and risks arising from fluctuations in the value of financial instruments by means of interest rate swaps, cross-currency swaps and other interest rate contracts with matching amounts and maturity dates. This also applies to financing arrangements within the Volkswagen Group.

Foreign currency risk is reduced in particular through natural hedging, i.e. by flexibly adapting our production capacity at our locations around the world, establishing new production facilities in the most important currency regions and also procuring a large percentage of components locally, currently for instance in Russia, China and Mexico. We hedge the residual foreign currency risk using hedging instruments. These include currency forwards, currency options and cross-currency swaps. We use these transactions to limit the currency risk associated with forecasted cash flows from operating activities and intragroup financing in currencies other than the respective functional currency. The currency forwards and currency options can have a term of up to six years. We use them to hedge our principal foreign currency risks associated with forecasted cash flows, mostly against the euro and primarily in US dollars, sterling, Chinese renminbi, Swiss francs, Mexican pesos, Swedish kronor, Polish zloty and Australian dollars.

Raw materials purchasing entails risks relating to the availability of raw materials and price trends. We limit these risks mainly by entering into forward transactions and swaps. We have used appropriate contracts to hedge some of our requirements for commodities such as aluminum, copper, lead, platinum, rhodium, palladium and coal over a period of up to seven years. Similar transactions have been entered into for the purpose of supplementing and improving allocations of CO<sub>2</sub> emission certificates.

Pages 254 to 261 of the notes to the consolidated financial statements explain our hedging policy, the hedging rules and the default and liquidity risks, and quantify the hedging transactions mentioned. Additionally, we outline the market risk within the meaning of IFRS 7.

#### Risks arising from financial instruments

Channeling excess liquidity into investments gives rise to counterparty risk. Partial or complete failure by a counterparty to perform its obligation to pay interest and repay principal would have a negative impact on the Volkswagen Group's earnings and liquidity. We counter this risk through our counterparty risk management, which we describe in more detail in the section entitled "Principles and Goals of Financial Management" starting on page 97. In addition to counterparty risk, the financial instruments held for hedging purposes hedge balance sheet risks, which we limit by applying hedge accounting.

By diversifying when we invest excess liquidity and by entering into financial instruments for hedging purposes, we ensure that the Volkswagen Group remains solvent at all times, even in the event of a default by individual counterparties.

Risks arising from trade receivables and from financial services are explained in more detail in the notes to the consolidated financial statements, starting on page 254.

#### Liquidity risks

We ensure that the Company remains solvent at all times by holding sufficient liquidity reserves, through confirmed credit lines and through our tried-and-tested money market and capital market programs. We cover the capital requirements of the growing financial services business mainly by raising funds at matching maturities in the national and international financial markets as well as through customer deposits from the direct banking business. Financing conditions in the reporting period were almost unchanged compared with 2012.

For this reason and thanks to the broadly diversified structure of our sources of funding, we were always able to raise sufficient liquidity in the various markets.

Credit lines from banks are only used within the Group to cover short-term working capital requirements. Projects are financed by, among other things, loans provided at favorable interest rates by development banks such as the European Investment Bank (EIB), the International Finance Corporation (IFC) and the European Bank for Reconstruction and Development (EBRD), or by national development banks such as Kreditanstalt für Wiederaufbau (KfW) and Banco Nacional de Desenvolvimento Econômico e Social (BNDES). This extensive range of options means that the liquidity risk to the Volkswagen Group is extremely low.

A downgrade of the Company's rating could adversely affect the terms attached to the Volkswagen Group's borrowings. However, in

light of Volkswagen's overall financial stability and flexibility, underpinned by the strong performance by its operating business, both Standard & Poor's and Moody's Investor Service affirmed the Group's existing ratings, in each case assigning a positive outlook. Information on the ratings of Volkswagen AG, Volkswagen Financial Services AG and Volkswagen Bank GmbH can be found on page 92 of this report.

In the reporting period, hybrid notes were issued in the amount of €2.0 billion in order to further strengthen our liquidity and capital base with a view toward future global growth and the systematic implementation of our Strategy 2018. In June 2013, in addition to the mandatory convertible note issued in November 2012 in the amount of €2.5 billion, Volkswagen AG successfully placed a further mandatory convertible note in the amount of €1.2 billion, which entitles and obliges holders to subscribe for Volkswagen preferred shares. These transactions increased not only the Volkswagen Group's net liquidity, but also its equity in accordance with International Financial Reporting Standards.

#### Residual value risk in the financial services business

In the financial services business, we agree to buy back selected vehicles at a residual value that is fixed at inception of the contract. Residual values are set realistically so that we are able to leverage market opportunities. We evaluate the underlying lease contracts at regular intervals and recognize any necessary provisions if we identify any potential risks.

Management of the residual value risk is based on a defined feedback loop ensuring the full assessment, monitoring, management and communication of risks. This process design ensures not only professional management of residual risks but also that we systematically improve and enhance our handling of residual value risks.

As part of our risk management, we use residual value forecasts to regularly assess the appropriateness of the provisions for risks and the potential for residual value risk. In the process, we compare the contractually agreed residual values with the fair values obtainable. These are determined utilizing data from external service providers and our own marketing data. We do not take account of the upside in residual market values when making provisions for risks.

More information on residual value risk and other risks in the financial services business, such as counterparty, market and liquidity risk, can be found in the 2013 Annual Report of Volkswagen Financial Services AG.

#### Other factors

Going beyond the risks already outlined, there are other factors that cannot be predicted and are therefore difficult to control. Should these transpire, they could have an adverse effect on the further development of the Volkswagen Group. In particular, these factors include natural disasters, epidemics and terror attacks.

#### OVERALL ASSESSMENT OF THE RISK AND OPPORTUNITY POSITION

The Volkswagen Group's overall risk and opportunity position results from the specific risks and opportunities shown above. We have put in place a comprehensive risk management system to ensure that these risks are controlled. The most significant risks to the Group may result from a negative trend in unit sales of, and markets for, vehicles and genuine parts, from the failure to develop and produce products in line with demand and from quality problems. Taking into account all the information known to us at present, no risks exist which could pose a threat to the continued existence of significant Group companies or the Volkswagen Group.

# *Prospects for 2014*

The Volkswagen Group's Board of Management expects the global economy to record slightly stronger growth in 2014 than in the previous year, despite some uncertainties. The financial markets still entail risks resulting above all from the strained debt situation of many countries. While the industrialized nations will probably record moderate rates of expansion, we continue to anticipate that growth will be strongest in the emerging economies of Asia.

In 2014, we expect trends in the passenger car markets in the individual regions to be mixed. Overall, growth in global demand for new vehicles will probably be somewhat slower than in the reporting period. We anticipate a slight recovery in demand for automobiles in Western Europe, and volumes in the German market are also likely to increase again somewhat in 2014. The passenger car markets in Central and Eastern Europe will only just exceed the prior-year level. The upward trend in North America will probably weaken, while the South American passenger car markets will be on a level with the previous year. We anticipate further growth in 2014 for the markets in the Asia-Pacific region that are strategically important for the Volkswagen Group, although momentum there is expected to be lower than in the previous year.

The global markets for light commercial vehicles will probably experience slight growth overall in 2014, with the individual regions recording mixed trends.

We anticipate that the overall volume in the markets for trucks and buses that are relevant for the Volkswagen Group will see a slight increase in 2014 as against the previous year, with the greatest growth expected in the second half of the year.

We expect demand for automotive financial services to grow worldwide again in 2014.

The Volkswagen Group is well positioned to deal with the mixed developments in the automotive markets. Our strengths include our unique brand portfolio covering almost all segments, from motor-

cycles through subcompact cars to heavy trucks and buses, our steadily growing presence in all major markets in the world and our wide range of financial services. We offer an extensive range of environmentally friendly, cutting-edge, high-quality vehicles for all markets and customer groups that is unparalleled in the industry. The Volkswagen Group will press ahead with its product initiative across all brands in 2014, and we will modernize and expand our offering by introducing attractive new vehicles. We are pursuing the goal of offering all customers the mobility and innovation they need, sustainably strengthening our competitive position in the process.

We expect that the Volkswagen Group will moderately increase deliveries to customers year-on-year in 2014 in a still challenging market environment.

Challenges for the Volkswagen Group will come from the difficult market environment and fierce competition, as well as interest rate and exchange rate volatility and fluctuations in raw materials prices. The modular toolkit system, which we are continuously expanding, will have an increasingly positive effect on the Group's cost structure.

Depending on the economic conditions, we expect 2014 sales revenue for the Volkswagen Group and its business areas to move within a range of 3% around the prior-year figure.

In terms of the Group's operating profit, we are expecting an operating return on sales of between 5.5% and 6.5% in 2014 in light of the challenging economic environment, and the same range for the Passenger Cars Business Area. The Commercial Vehicles/Power Engineering Business Area is likely to moderately exceed the 2013 figure. The operating return on sales in the Financial Services Division is expected to be between 8.0% and 9.0%. Disciplined cost and investment management and the continuous optimization of our processes remain integral elements of the Volkswagen Group's Strategy 2018.

Wolfsburg, February 11, 2014  
The Board of Management



# 4

# *Consolidated Financial Statements*

VOLKSWAGEN GROUP OPERATING PROFIT (in € billion)





.....  
.....  
**CONSOLIDATED FINANCIAL STATEMENTS**  
.....  
.....  
.....

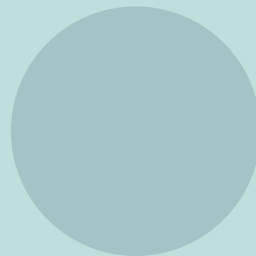
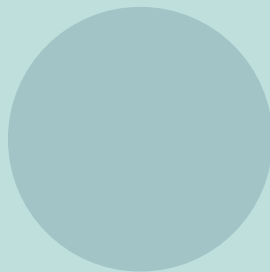
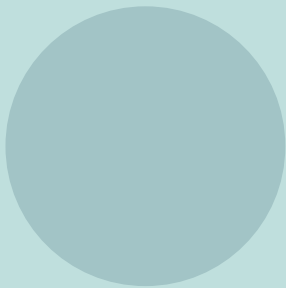

169	Income Statement	226	18. Noncurrent and current other receivables
170	Statement of Comprehensive Income	227	19. Tax assets
172	Balance Sheet	227	20. Inventories
174	Statement of Changes in Equity	227	21. Trade receivables
176	Cash Flow Statement	228	22. Marketable securities
		228	23. Cash, cash equivalents and time deposits
177	<b>Notes</b>	229	24. Equity
177	Basis of presentation	231	25. Noncurrent and current financial liabilities
177	Effects of new and amended IFRSs	231	26. Noncurrent and current other financial liabilities
180	New and amended IFRSs not applied	232	27. Noncurrent and current other liabilities
181	Basis of consolidation	233	28. Tax liabilities
190	Consolidation methods	233	29. Provisions for pensions and other post-employment benefits
191	Currency translation	240	30. Noncurrent and current other provisions
192	Accounting policies	241	31. Trade payables
201	Segment reporting	241	Disclosures in Accordance with IFRS 7 (Financial Instruments)
205	Income Statement Disclosures	251	Other Disclosures
205	1. Sales revenue	251	32. Cash flow statement
205	2. Cost of sales	252	33. Financial risk management and financial instruments
205	3. Distribution expenses	260	34. Capital management
206	4. Administrative expenses	261	35. Contingent liabilities
206	5. Other operating income	262	36. Litigation
206	6. Other operating expenses	263	37. Other financial obligations
207	7. Share of profits and losses of equity-accounted investments	264	38. Total audit fees of the Group auditors
207	8. Finance costs	264	39. Total expense for the period
208	9. Other financial result	265	40. Average number of employees during the year
208	10. Income tax income/expense	265	41. Events after the balance sheet date
211	11. Earnings per share	266	42. Related party disclosures in accordance with IAS 24
213	Disclosures in Accordance with IAS 23 (Borrowing Costs)	271	43. Notices and disclosure of changes regarding the ownership of voting rights in Volkswagen AG in accordance with the Wertpapierhandelsgesetz (WpHG – German Securities Trading Act)
213	Disclosures in Accordance with IFRS 7 (Financial Instruments)	282	44. German Corporate Governance Code
215	Balance Sheet Disclosures	282	45. Remuneration of the Board of Management and the Supervisory Board
215	12. Intangible assets	283	Responsibility Statement
218	13. Property, plant and equipment	284	Auditor's Report
220	14. Leasing and rental assets and Investment property		
222	15. Equity-accounted investments and other equity investments		
224	16. Noncurrent and current financial services receivables		
225	17. Noncurrent and current other financial assets		





# Income Statement

OF THE VOLKSWAGEN GROUP FOR THE PERIOD JANUARY 1 TO DECEMBER 31, 2013

€ million	Note	2013	2012*
<b>Sales revenue</b>	<b>1</b>	<b>197,007</b>	<b>192,676</b>
Cost of sales	2	-161,407	-157,522
<b>Gross profit</b>		<b>35,600</b>	<b>35,154</b>
Distribution expenses	3	-19,655	-18,850
Administrative expenses	4	-6,888	-6,220
Other operating income	5	9,956	10,484
Other operating expenses	6	-7,343	-9,070
<b>Operating profit</b>		<b>11,671</b>	<b>11,498</b>
Share of profits and losses of equity-accounted investments	7	3,588	13,568
Finance costs	8	-2,366	-2,546
Other financial result	9	-465	2,967
<b>Financial result</b>		<b>757</b>	<b>13,989</b>
<b>Profit before tax</b>		<b>12,428</b>	<b>25,487</b>
Income tax income/expense	10	-3,283	-3,606
Current		-3,733	-4,196
Deferred		449	589
<b>Profit after tax</b>		<b>9,145</b>	<b>21,881</b>
of which attributable to			
Noncontrolling interests		52	169
Volkswagen AG hybrid capital investors		27	-
Volkswagen AG shareholders		9,066	21,712
<b>Basic earnings per ordinary share in €</b>	<b>11</b>	<b>18.63</b>	<b>46.41</b>
<b>Diluted earnings per ordinary share in €</b>	<b>11</b>	<b>18.63</b>	<b>46.41</b>
<b>Basic earnings per preferred share in €</b>	<b>11</b>	<b>18.69</b>	<b>46.47</b>
<b>Diluted earnings per preferred share in €</b>	<b>11</b>	<b>18.69</b>	<b>46.47</b>

\* Prior-year figures adjusted to reflect application of IAS 33.26 and IAS 19R.

# Statement of Comprehensive Income

## CHANGES IN COMPREHENSIVE INCOME FOR THE PERIOD JANUARY 1 TO DECEMBER 31, 2012<sup>1</sup>

€ million	Total	Equity attributable to Volkswagen AG shareholders	Equity attributable to Volkswagen AG hybrid capital investors	Equity attributable to noncontrolling interests
<b>Profit after tax</b>	<b>21,881</b>	<b>21,712</b>	–	<b>169</b>
Pension plan remeasurements recognized in other comprehensive income				
Pension plan remeasurements recognized in other comprehensive income, before tax	–5,589	–5,480	–	–109
Deferred taxes relating to pension plan remeasurements recognized in other comprehensive income	1,632	1,603	–	29
Pension plan remeasurements recognized in other comprehensive income, net of tax	–3,957	–3,877	–	–81
Share of other comprehensive income of equity-accounted investments that will not be reclassified to profit or loss, net of tax <sup>2</sup>	–72	–72	–	–
<b>Items that will not be reclassified to profit or loss</b>	<b>–4,029</b>	<b>–3,948</b>	–	<b>–81</b>
Exchange differences on translating foreign operations				
Unrealized currency translation gains/losses	–212	–207	–	–5
Transferred to profit or loss	–	–	–	–
Exchange differences on translating foreign operations, before tax	–212	–207	–	–5
Deferred taxes relating to exchange differences on translating foreign operations	0	0	–	–
Exchange differences on translating foreign operations, net of tax	–212	–207	–	–5
Cash flow hedges				
Fair value changes recognized in other comprehensive income	1,570	1,565	–	5
Transferred to profit or loss	951	951	–	–
Cash flow hedges, before tax	2,521	2,516	–	5
Deferred taxes relating to cash flow hedges	–719	–719	–	0
Cash flow hedges, net of tax	1,802	1,797	–	5
Available-for-sale financial assets				
Fair value changes recognized in other comprehensive income	493	493	–	–
Transferred to profit or loss	–32	–32	–	–
Available-for-sale financial assets, before tax	461	461	–	–
Deferred taxes relating to available-for-sale financial assets	–13	–13	–	–
Available-for-sale financial assets, net of tax	448	448	–	–
Share of other comprehensive income of equity-accounted investments that may be reclassified subsequently to profit or loss, net of tax <sup>2</sup>	150	150	–	–1
<b>Items that may be reclassified subsequently to profit or loss</b>	<b>2,187</b>	<b>2,188</b>	–	<b>–1</b>
Other comprehensive income, before tax	–2,742	–2,631	–	–110
Deferred taxes relating to other comprehensive income	900	871	–	29
<b>Other comprehensive income, net of tax</b>	<b>–1,842</b>	<b>–1,760</b>	–	<b>–81</b>
<b>Total comprehensive income</b>	<b>20,039</b>	<b>19,952</b>	–	<b>87</b>

1 Presentation adjusted to reflect application of IAS 1R and figures adjusted to reflect application of IAS 19R.

2 Including expenses of €316 million transferred to profit or loss due to the change in the accounting for Porsche Holding Stuttgart.

CONSOLIDATED FINANCIAL STATEMENTS  
Statement of Comprehensive Income

**CHANGES IN COMPREHENSIVE INCOME FOR THE PERIOD  
JANUARY 1 TO DECEMBER 31, 2013**

€ million	Total	Equity attributable to Volkswagen AG shareholders	Equity attributable to Volkswagen AG hybrid capital investors	Equity attributable to noncontrolling interests
<b>Profit after tax</b>	<b>9,145</b>	<b>9,066</b>	<b>27</b>	<b>52</b>
Pension plan remeasurements recognized in other comprehensive income				
Pension plan remeasurements recognized in other comprehensive income, before tax	2,367	2,303	–	64
Deferred taxes relating to pension plan remeasurements recognized in other comprehensive income	–664	–651	–	–14
Pension plan remeasurements recognized in other comprehensive income, net of tax	1,703	1,653	–	50
Share of other comprehensive income of equity-accounted investments that will not be reclassified to profit or loss, net of tax	–6	–6	–	–
<b>Items that will not be reclassified to profit or loss</b>	<b>1,697</b>	<b>1,647</b>	<b>–</b>	<b>50</b>
Exchange differences on translating foreign operations				
Unrealized currency translation gains/losses	–2,387	–2,240	–	–147
Transferred to profit or loss	–	–	–	–
Exchange differences on translating foreign operations, before tax	–2,387	–2,240	–	–147
Deferred taxes relating to exchange differences on translating foreign operations	1	1	–	–
Exchange differences on translating foreign operations, net of tax	–2,387	–2,239	–	–147
Cash flow hedges				
Fair value changes recognized in other comprehensive income	2,268	2,270	–	–1
Transferred to profit or loss	–118	–118	–	0
Cash flow hedges, before tax	2,150	2,152	–	–1
Deferred taxes relating to cash flow hedges	–650	–651	–	1
Cash flow hedges, net of tax	1,500	1,501	–	–1
Available-for-sale financial assets				
Fair value changes recognized in other comprehensive income	141	141	–	–
Transferred to profit or loss	–34	–34	–	–
Available-for-sale financial assets, before tax	107	107	–	–
Deferred taxes relating to available-for-sale financial assets	–7	–7	–	–
Available-for-sale financial assets, net of tax	100	100	–	–
Share of other comprehensive income of equity-accounted investments that may be reclassified subsequently to profit or loss, net of tax	–164	–164	–	–1
<b>Items that may be reclassified subsequently to profit or loss</b>	<b>–951</b>	<b>–802</b>	<b>–</b>	<b>–149</b>
Other comprehensive income, before tax	2,067	2,152	–	–86
Deferred taxes relating to other comprehensive income	–1,321	–1,308	–	–13
<b>Other comprehensive income, net of tax</b>	<b>746</b>	<b>844</b>	<b>–</b>	<b>–99</b>
<b>Total comprehensive income</b>	<b>9,891</b>	<b>9,910</b>	<b>27</b>	<b>–47</b>

# Balance Sheet

OF THE VOLKSWAGEN GROUP AS OF DECEMBER 31, 2013

€ million	Note	Dec. 31, 2013	Dec. 31, 2012 <sup>1</sup>	Jan. 1, 2012 <sup>1</sup>
<b>Assets</b>				
<b>Noncurrent assets</b>				
Intangible assets	12	59,243	59,112	22,176
Property, plant and equipment	13	42,389	39,424	31,876
Leasing and rental assets	14	22,259	20,034	16,626
Investment property	14	427	433	340
Equity-accounted investments	15	7,934	7,309	10,249
Other equity investments	15	3,941	3,870	3,049
Financial services receivables	16	51,198	49,785	42,450
Other financial assets	17	7,040	6,431	12,823
Other receivables	18	1,456	1,671	1,582
Tax receivables	19	633	552	627
Deferred tax assets	19	5,622	7,836	6,273
		<b>202,141</b>	<b>196,457</b>	<b>148,069</b>
<b>Current assets</b>				
Inventories	20	28,653	28,674	27,551
Trade receivables	21	11,133	10,099	10,479
Financial services receivables	16	38,386	36,911	33,754
Other financial assets	17	6,591	5,872	4,253
Other receivables	18	5,030	4,823	4,543
Tax receivables	19	729	761	623
Marketable securities	22	8,492	7,433	6,146
Cash, cash equivalents and time deposits	23	23,178	18,488	18,291
		<b>122,192</b>	<b>113,061</b>	<b>105,640</b>
<b>Total assets</b>		<b>324,333</b>	<b>309,518</b>	<b>253,708</b>

CONSOLIDATED FINANCIAL STATEMENTS  
Balance Sheet

€ million	Note	Dec. 31, 2013	Dec. 31, 2012 <sup>1</sup>	Jan. 1, 2012 <sup>1</sup>
<b>Equity and Liabilities</b>				
<b>Equity</b>	<b>24</b>			
Subscribed capital		1,191	1,191	1,191
Capital reserves		12,658	11,509	9,329
Retained earnings <sup>2</sup>		72,341	64,596	49,069
Other reserves <sup>2</sup>		-459	386	-1,879
Equity attributable to Volkswagen AG hybrid capital investors		2,004	-	-
Equity attributable to Volkswagen AG shareholders and hybrid capital investors		87,733	77,682	57,710
Noncontrolling interests <sup>3</sup>		2,304	4,313	5,817
		<b>90,037</b>	<b>81,995</b>	<b>63,528</b>
<b>Noncurrent liabilities</b>				
Financial liabilities	25	61,517	63,603	44,442
Other financial liabilities	26	2,305	2,397	2,547
Other liabilities	27	4,527	4,675	4,394
Deferred tax liabilities	28	7,894	9,050	4,055
Provisions for pensions	29	21,774	23,939	16,756
Provisions for taxes	28	3,674	4,239	3,721
Other provisions	30	13,981	14,094	13,061
		<b>115,672</b>	<b>121,996</b>	<b>88,975</b>
<b>Current liabilities</b>				
Put options and compensation rights granted to noncontrolling interest shareholders <sup>3</sup>		3,638	-	-
Financial liabilities	25	59,987	54,060	49,090
Trade payables	31	18,024	17,268	16,325
Tax payables	28	218	238	844
Other financial liabilities	26	4,526	4,425	4,888
Other liabilities	27	11,004	11,111	11,196
Provisions for taxes	28	2,869	1,721	2,888
Other provisions	30	18,360	16,702	15,974
		<b>118,625</b>	<b>105,526</b>	<b>101,205</b>
<b>Total equity and liabilities</b>		<b>324,333</b>	<b>309,518</b>	<b>253,708</b>

1 Prior-year figures adjusted to reflect application of IAS 19R.

2 Retained earnings comprise other retained earnings and actuarial gains and losses. The other items are presented as "Other reserves". The prior-year figures were adjusted accordingly.

3 Following the approval by the Annual General Meeting of MAN SE of the conclusion of a control and profit and loss transfer agreement on June 6, 2013, the noncontrolling interests in the equity of MAN SE were derecognized from Group equity as a capital transaction involving a change in ownership interest. At the same time, a liability was recognized as a separate item of current liabilities in accordance with the cash settlement offer.

# Statement of Changes in Equity

OF THE VOLKSWAGEN GROUP FOR THE PERIOD JANUARY 1 TO DECEMBER 31, 2013

€ million	OTHER RESERVES			
	Subscribed capital	Capital reserves	Retained earnings	Currency translation reserve
<b>Unadjusted balance at Jan. 1, 2012</b>	<b>1,191</b>	<b>9,329</b>	<b>48,898</b>	<b>-332</b>
Changes in accounting policy to reflect IAS 19R	-	-	172	-
<b>Adjusted balance at Jan. 1, 2012</b>	<b>1,191</b>	<b>9,329</b>	<b>49,069</b>	<b>-332</b>
Profit after tax <sup>1</sup>	-	-	21,712	-
Other comprehensive income, net of tax	-	-	-3,877	-207
<b>Total comprehensive income<sup>1</sup></b>	<b>-</b>	<b>-</b>	<b>17,835</b>	<b>-207</b>
Capital increase	0	2,180	-	-
Dividend payment	-	-	-1,406	-
Capital transactions involving a change in ownership interest <sup>2</sup>	-	-	-762	-
Other changes	-	-	-141	-
<b>Balance at Dec. 31, 2012<sup>1</sup></b>	<b>1,191</b>	<b>11,509</b>	<b>64,596</b>	<b>-539</b>
<b>Unadjusted balance at Jan. 1, 2013</b>	<b>1,191</b>	<b>11,509</b>	<b>64,429</b>	<b>-539</b>
Changes in accounting policy to reflect IAS 19R	-	-	167	-
<b>Adjusted balance at Jan. 1, 2013</b>	<b>1,191</b>	<b>11,509</b>	<b>64,596</b>	<b>-539</b>
Profit after tax	-	-	9,066	-
Other comprehensive income, net of tax	-	-	1,653	-2,239
<b>Total comprehensive income</b>	<b>-</b>	<b>-</b>	<b>10,719</b>	<b>-2,239</b>
Capital increase <sup>3</sup>	0	1,149	-	-
Dividend payment	-	-	-1,639	-
Capital transactions involving a change in ownership interest <sup>2</sup>	-	-	-1,328	-21
Other changes	-	-	-7	0
<b>Balance at Dec. 31, 2013</b>	<b>1,191</b>	<b>12,658</b>	<b>72,341</b>	<b>-2,799</b>

1 Figures adjusted to reflect application of IAS 19R.

2 The capital transactions involving a change in ownership interest are attributable in the previous year in particular to the increase in the equity interest in MAN SE and, in the reporting period, to the derecognition of the noncontrolling interests in the equity of MAN SE and the interest in Scania AB attributable to these noncontrolling interest shareholders.

3 Volkswagen AG recorded an inflow of cash funds amounting to €1,200 million, plus the premium and deferred interest (€69 million) and less transaction costs (€14 million), from the mandatory convertible note placed in June 2013. Additionally, there are noncash effects from the deferral of taxes amounting to €49 million. €1,149 million of the total amount is required to be classified as equity instruments granted. The residual amount is classified as debt. Volkswagen AG also recorded an inflow of cash funds amounting to €2,000 million, less a discount of €18 million and transaction costs (€14 million), from the hybrid capital issued in the course of the fiscal year. Additionally, there are noncash effects from the deferral of taxes amounting to €9 million. The hybrid capital is required to be classified as equity instruments granted.

Explanatory notes on equity are presented in note 24.

CONSOLIDATED FINANCIAL STATEMENTS  
Statement of Changes in Equity

	Cash flow hedges	Available-for-sale financial assets	Equity-accounted investments	Equity attributable to Volkswagen AG hybrid capital investors	Equity attributable to Volkswagen AG shareholders and hybrid capital investors	Noncontrolling interests	Total equity
	-1,437	176	-286	-	57,539	5,815	63,354
	-	-	-	-	172	3	174
	-1,437	176	-286	-	57,710	5,817	63,528
	-	-	-	-	21,712	169	21,881
	1,797	448	79	-	-1,760	-81	-1,842
	1,797	448	79	-	19,952	87	20,039
	-	-	-	-	2,180	-	2,180
	-	-	-	-	-1,406	-267	-1,673
	-	-	-	-	-762	-1,339	-2,101
	-	-	148	-	8	14	22
	360	624	-59	-	77,682	4,313	81,995
	360	624	-59	-	77,515	4,310	81,825
	-	-	-	-	167	4	171
	360	624	-59	-	77,682	4,313	81,995
	-	-	-	27	9,093	52	9,145
	1,501	100	-170	-	844	-99	746
	1,501	100	-170	27	9,938	-47	9,891
	-	-	-	1,976	3,125	-	3,125
	-	-	-	-	-1,639	-210	-1,849
	-16	0	-1	-	-1,366	-1,759	-3,125
	0	0	1	-	-6	7	1
	1,845	724	-229	2,004	87,733	2,304	90,037

# Cash Flow Statement

OF THE VOLKSWAGEN GROUP FOR THE PERIOD JANUARY 1 TO DECEMBER 31, 2013

€ million	2013	2012 <sup>1</sup>
<b>Cash and cash equivalents at beginning of period</b>	<b>17,794</b>	<b>16,495</b>
Profit before tax	12,428	25,487
Income taxes paid	-3,107	-5,056
Depreciation and amortization of, and impairment losses on, intangible assets, property, plant and equipment, and investment property <sup>2</sup>	8,007	7,617
Amortization and write-downs of capitalized development costs <sup>2</sup>	2,464	1,903
Impairment losses on equity investments <sup>2</sup>	36	20
Depreciation of, and impairment losses on, leasing and rental assets <sup>2</sup>	4,179	3,594
Gain/loss on disposal of noncurrent assets	-35	-32
Share of profit or loss of equity-accounted investments	-759	-11,512
Other noncash expense/income	1,012	-2,031
Change in inventories	-1,021	460
Change in receivables (excluding financial services)	-1,651	-56
Change in liabilities (excluding financial liabilities)	2,363	-236
Change in provisions	2,479	470
Change in leasing and rental assets	-7,112	-5,606
Change in financial services receivables	-6,688	-7,814
<b>Cash flows from operating activities</b>	<b>12,595</b>	<b>7,209</b>
Investments in intangible assets (excluding capitalized development costs), property, plant and equipment, and investment property	-11,385	-10,493
Additions to capitalized development costs	-4,021	-2,615
Acquisition of subsidiaries	-80	-3,550
Acquisition of other equity investments	-94	-570
Disposal of subsidiaries	0	0
Disposal of other equity investments	23	14
Proceeds from disposal of intangible assets, property, plant and equipment, and investment property	622	373
Change in investments in securities	-810	-1,133
Change in loans and time deposits	-1,144	-1,510
<b>Cash flows from investing activities</b>	<b>-16,890</b>	<b>-19,482</b>
Capital contributions	3,067	2,046
Dividends paid	-1,849	-1,673
Capital transactions with noncontrolling interest shareholders	0	-2,101
Other changes	-21	36
Proceeds from issuance of bonds	22,118	26,055
Repayment of bonds	-14,614	-16,952
Change in other financial liabilities	285	6,432
Lease payments	-14	-132
<b>Cash flows from financing activities</b>	<b>8,973</b>	<b>13,712</b>
Effect of exchange rate changes on cash and cash equivalents	-462	-141
<b>Net change in cash and cash equivalents</b>	<b>4,216</b>	<b>1,298</b>
<b>Cash and cash equivalents at end of period</b>	<b>22,009</b>	<b>17,794</b>
Cash and cash equivalents at end of period	22,009	17,794
Securities, loans and time deposits	17,177	14,352
<b>Gross liquidity</b>	<b>39,186</b>	<b>32,146</b>
Total third-party borrowings	-121,504	-117,663
<b>Net liquidity</b>	<b>-82,318</b>	<b>-85,517</b>

1 Prior-year figures adjusted to reflect application of IAS 19R.

2 Net of impairment reversals.

Explanatory notes on the cash flow statement are presented in note 32.



# Notes to the Consolidated Financial Statements

OF THE VOLKSWAGEN GROUP AS OF DECEMBER 31, 2013

## Basis of presentation

Volkswagen AG is domiciled in Wolfsburg, Germany, and entered in the commercial register at the Braunschweig Local Court under no. HRB 100484. The fiscal year corresponds to the calendar year.

In accordance with Regulation No. 1606/2002 of the European Parliament and of the Council, Volkswagen AG prepared its consolidated financial statements for 2013 in compliance with the International Financial Reporting Standards (IFRSs), as adopted by the European Union. We have complied with all the IFRSs adopted by the EU and required to be applied.

The accounting policies applied in the previous year were retained, with the exception of the changes due to the new or amended standards.

In addition, we have complied with all the provisions of German commercial law that we are also required to apply, as well as with the German Corporate Governance Code.

The consolidated financial statements were prepared in euros. Unless otherwise stated, all amounts are given in millions of euros (€ million).

All figures shown are rounded, so minor discrepancies may arise from addition of these amounts.

The income statement was prepared using the internationally accepted cost of sales method.

Preparation of the consolidated financial statements in accordance with the above-mentioned standards requires management to make estimates that affect the reported amounts of certain items in the consolidated balance sheet and in the consolidated income statement, as well as the related disclosure of contingent assets and liabilities. The consolidated financial statements present fairly the net assets, financial position and results of operations as well as the cash flows of the Volkswagen Group.

The Board of Management completed preparation of the consolidated financial statements on February 11, 2014. On that date, the period ended in which adjusting events after the reporting period are recognized.

## Effects of new and amended IFRSs

Volkswagen AG has adopted all accounting pronouncements required to be applied starting in fiscal year 2013.

The amendment to IAS 36 (2013) "Recoverable Amount Disclosures for Nonfinancial Assets" was voluntarily applied early in the Volkswagen consolidated financial statements in the current fiscal year. The amendments clarify and correct the disclosure requirements for recoverable amount under IFRS 13.

IAS 1R revises the way that the reconciliation of comprehensive income for the period is presented. It requires items of other comprehensive income to be presented separately by items that will never be reclassified to profit or loss and items that may be reclassified subsequently to profit or loss if certain conditions are met. In addition, the related tax effects must be allocated to these two groups of items. Volkswagen AG has modified the statement of comprehensive income in these consolidated financial statements in line with this. The other amendments to IAS 1 do not affect the presentation of the Volkswagen Group's net assets, financial position and results of operations.

The statement of changes in equity was also modified in this context. In these consolidated financial statements, the retained earnings are composed of other retained earnings and actuarial gains and losses. The other items are classified as "Other reserves".

IAS 19R changes the way employee benefits are accounted for. This results in the following changes in particular in Volkswagen AG's consolidated financial statements:

- > Bonus payments for partial retirement agreements are attributed to the periods of service over the accumulation period in the block model used in the Volkswagen Group.
- > Past service cost for defined benefit obligations is recognized directly in profit or loss.
- > The defined benefit obligation and plan assets are discounted using the same discount rate (net interest approach).

The following tables present the material effects of applying IAS 19R:

€ million	DECEMBER 31, 2012			JANUARY 1, 2012		
	Unadjusted	Adjustment	Adjusted	Unadjusted	Adjustment	Adjusted
<b>Total assets</b>	<b>309,644</b>	<b>-126</b>	<b>309,518</b>	<b>253,769</b>	<b>-61</b>	<b>253,708</b>
of which: deferred tax assets	7,915	-79	7,836	6,333	-61	6,273
of which: intangible assets	59,158	-46	59,112	22,176	-	22,176
<b>Total liabilities and provisions</b>	<b>227,819</b>	<b>-296</b>	<b>227,523</b>	<b>190,416</b>	<b>-235</b>	<b>190,181</b>
of which: other provisions, pension provisions	55,032	-296	54,735	46,027	-235	45,792
<b>Total equity</b>	<b>81,825</b>	<b>171</b>	<b>81,995</b>	<b>63,354</b>	<b>174</b>	<b>63,528</b>
of which: retained earnings	64,429	167	64,596	48,898	172	49,069

€ million	TWELVE MONTHS ENDED DECEMBER 31, 2012		
	Unadjusted	Adjustment	Adjusted
<b>Profit before tax</b>	<b>25,492</b>	<b>-5</b>	<b>25,487</b>
of which: other financial result (incl. finance costs)	414	7	421
Income tax expense	3,608	-1	3,606
<b>Profit after tax</b>	<b>21,884</b>	<b>-4</b>	<b>21,881</b>
Profit attributable to Volkswagen AG shareholders	21,717	-4	21,712
Basic earnings per ordinary share (€)	46.42	-0.01	46.41
Diluted earnings per ordinary share (€)	46.42	-0.01	46.41
Basic earnings per preferred share (€)	46.48	-0.01	46.47
Diluted earnings per preferred share (€)	46.48	-0.01	46.47

On August 1, 2012, Porsche Automobil Holding SE, Stuttgart (Porsche SE), contributed its holding company operating business to Volkswagen AG by way of singular succession in the course of a capital increase with a mixed noncash contribution. Volkswagen accounted for this transaction in accordance with IFRS 3. Partial retirement obligations were also assumed in this connection. The changes resulting from the application of IAS 19R must be applied retrospectively, i.e. as if the new accounting policy had always been applied. For this reason, the adjustment resulting from application of IAS 19R to the recognition and measurement of the partial retirement obligations must be charged to goodwill at the acquisition date. This resulted in the following adjustments as of August 1, 2012: deferred tax assets were reduced by €20 million, intangible assets were reduced by €46 million and liabilities and provisions were reduced by €66 million.

**CONSOLIDATED FINANCIAL STATEMENTS**  
Notes to the Consolidated Financial Statements

The other amendments to IAS 19 do not materially affect the presentation of the net assets, financial position and results of operations in Volkswagen AG's consolidated financial statements.

The following tables present the effects of retaining IAS 19 (2008) on the balance sheet as of December 31, 2013 as well as on the income statement and the statement of comprehensive income in fiscal year 2013:

€ million	DECEMBER 31, 2013		
	Under IAS 19 (2011)	Adjustment	Under IAS 19 (2008)
<b>Total assets</b>	<b>324,333</b>	<b>130</b>	<b>324,463</b>
of which: deferred tax assets	5,622	84	5,706
of which: intangible assets	59,243	46	59,289
<b>Total liabilities and provisions</b>	<b>234,297</b>	<b>310</b>	<b>234,607</b>
of which: other provisions, pension provisions	54,115	310	54,425
<b>Total equity</b>	<b>90,037</b>	<b>-179</b>	<b>89,858</b>
of which: retained earnings	72,341	-179	72,162

€ million	TWELVE MONTHS ENDED DECEMBER 31, 2013		
	Under IAS 19 (2011)	Adjustment	Under IAS 19 (2008)
<b>Profit before tax</b>	<b>12,428</b>	<b>50</b>	<b>12,478</b>
of which: other financial result (incl. finance costs)	-2,831	64	-2,767
Income tax expense	-3,283	5	-3,278
<b>Profit after tax</b>	<b>9,145</b>	<b>56</b>	<b>9,201</b>
Profit attributable to Volkswagen AG shareholders	9,066	56	9,122
Basic earnings per ordinary share (€)	18.63	0.11	18.74
Diluted earnings per ordinary share (€)	18.63	0.11	18.74
Basic earnings per preferred share (€)	18.69	0.11	18.80
Diluted earnings per preferred share (€)	18.69	0.11	18.80

IFRS 13 sets out general requirements for measuring fair value in a separate standard. Volkswagen therefore applies the requirements of IFRS 13 governing fair value measurement. Fair value measurement did not materially affect the presentation of the net assets, financial position and results of operations in Volkswagen AG's consolidated financial statements. Furthermore, IFRS 13 specifically affects the notes to the consolidated financial statements. Information has been added about the levels of the fair value hierarchy within which certain assets and liabilities are categorized, along with further explanatory notes on fair value measurement.

The amendments to IFRS 7 result in additional disclosures relating to offsetting financial assets and financial liabilities. In particular, the additional reporting requirements affect the disclosure of netting arrangements under which the right of set-off is contingent on specific future events.

The other accounting pronouncements required to be applied for the first time in fiscal year 2013 are insignificant for the presentation of the net assets, financial position and results of operations in Volkswagen AG's consolidated financial statements.

## New and amended IFRSs not applied

In its 2013 consolidated financial statements, Volkswagen AG did not apply the following accounting pronouncements that have already been adopted by the IASB, but were not yet required to be applied for the fiscal year.

Standard/Interpretation	Issued by the IASB	Effective date <sup>1</sup>	Adopted by the EU	Expected effects	
IFRS 9	Financial Instruments: Classification and Measurement	Nov. 12, 2009/ Oct. 28, 2010	Still to be determined	No	Change in the accounting treatment of fair value changes in financial instruments previously classified as available for sale
IFRS 9	Financial Instruments: Hedge Accounting	Nov. 19, 2013	Still to be determined	No	Extended designation options, simplified effectiveness testing, increased disclosures
IFRS 10	Financial Instruments: Mandatory Effective Date and Transition Disclosures (Amendments to IFRS 9 and IFRS 7)	Dec. 16, 2011	Still to be determined	No	Increased disclosures
IFRS 11	Consolidated Financial Statements	May 12, 2011	Jan. 1, 2014	Yes	No material effects
IFRS 11	Joint Arrangements	May 12, 2011	Jan. 1, 2014	Yes	No material effects
IFRS 12	Disclosures of Interests in Other Entities	May 12, 2011	Jan. 1, 2014	Yes	Enhanced disclosures on interests in other entities
	Transition Guidance on IFRS 10, IFRS 11, IFRS 12	June 28, 2012	Jan. 1, 2014	Yes	No material effects
	Investment Entities (Amendments to IFRS 10, IFRS 12, IAS 27)	Oct. 31, 2012	Jan. 1, 2014	Yes	None
IFRS 14	Regulatory Deferral Accounts	Jan. 30, 2014	Jan. 1, 2016	No	None
IAS 19	Employee Benefits: Defined Benefit Plans – Employee Contributions	Nov. 21, 2013	Jan. 1, 2015	No	No material effects
IAS 27	Separate Financial Statements	May 12, 2011	Jan. 1, 2014	Yes	None
IAS 28	Investments in Associates and Joint Ventures	May 12, 2011	Jan. 1, 2014	Yes	None
IAS 32	Financial Instruments: Presentation – Offsetting Financial Assets and Financial Liabilities	Dec. 16, 2011	Jan. 1, 2014	Yes	No material effects
IAS 39	Financial Instruments: Novation of Derivatives and Continuation of Hedge Accounting	June 27, 2013	Jan. 1, 2014	Yes	No material effects
	Improvements to IFRSs 2012 <sup>2</sup>	Dec. 10, 2013	July 1, 2014 <sup>3</sup>	No	Primarily increased disclosures in the segment reporting
	Improvements to IFRSs 2013 <sup>4</sup>	Dec. 10, 2013	Jan. 1, 2015	No	No material effects
IFRIC 21	Levies	May 20, 2013	Jan. 1, 2014	No	None

1 Effective date for Volkswagen AG.

2 Minor amendments to a number of IFRSs (IFRS 2, IFRS 3, IFRS 8, IFRS 13, IAS 16/38, IAS 24).

3 This relates to the effective date of the amendments to IFRS 2 and IFRS 3; the effective date for the amendments to IFRS 8, IAS 16, IAS 24 and IAS 38 is January 1, 2015.

4 Minor amendments to a number of IFRSs (IFRS 1, IFRS 3, IFRS 13, IAS 40).

## Basis of consolidation

In addition to Volkswagen AG, the consolidated financial statements comprise all significant companies at which Volkswagen AG is able, directly or indirectly, to govern the financial and operating policies in such a way that it can obtain benefits from the activities of these companies (subsidiaries). The subsidiaries also comprise special purpose entities whose net assets are attributable to the Group under the principle of substance over form. The special purpose entities are used primarily to enter into asset-backed securities transactions to refinance the financial services business. Consolidation of subsidiaries begins at the first date on which control exists, and ends when such control no longer exists.

Subsidiaries whose business is dormant or of low volume and that are insignificant, both individually and in the aggregate, for the fair presentation of the net assets, financial position and results of operations as well as the cash flows of the Volkswagen Group are not consolidated. They are carried in the consolidated financial statements at the lower of cost or fair value since no active market exists for these companies and fair values cannot be reliably ascertained without undue cost or effort.

Significant companies where Volkswagen AG is able, directly or indirectly, to significantly influence financial and operating policy decisions (associates), or that are directly or indirectly jointly controlled (joint ventures), are accounted for using the equity method. Joint ventures also include companies in which the Volkswagen Group holds the majority of voting rights, but whose articles of association or partnership agreements stipulate that important decisions may only be resolved unanimously. Insignificant associates and joint ventures are generally carried at the lower of cost or fair value.

The composition of the Volkswagen Group is shown in the following table:

	2013	2012
Volkswagen AG and consolidated subsidiaries		
Germany	158	156
Abroad	854	825
Subsidiaries carried at cost		
Germany	65	73
Abroad	209	206
Associates, joint ventures and other equity investments		
Germany	41	36
Abroad	65	68
	<b>1,392</b>	<b>1,364</b>

The list of all shareholdings that forms part of the annual financial statements of Volkswagen AG can be downloaded from the electronic companies register at [www.unternehmensregister.de](http://www.unternehmensregister.de) and from [www.volkswagenag.com/ir](http://www.volkswagenag.com/ir) by clicking on "Further mandatory Publications" under the heading "Mandatory Publications".

The following consolidated German subsidiaries with the legal form of a corporation or partnership meet the criteria set out in section 264(3) or section 264b of the Handelsgesetzbuch (HGB – German Commercial Code) due to their inclusion in the consolidated financial statements and have as far as possible exercised the option not to publish annual financial statements:

- > Audi Akademie GmbH, Ingolstadt
- > Audi Berlin GmbH, Berlin
- > Audi Frankfurt GmbH, Frankfurt am Main
- > Audi Hamburg GmbH, Hamburg
- > Audi Hannover GmbH, Hanover
- > Audi Leipzig GmbH, Leipzig
- > Audi Stuttgart GmbH, Stuttgart
- > Audi Vertriebsbetreuungsgesellschaft mbH, Ingolstadt
- > Audi Zentrum München GmbH, Munich
- > Automobilmanufaktur Dresden GmbH, Dresden
- > Autostadt GmbH, Wolfsburg
- > AutoVision GmbH, Wolfsburg
- > Bugatti Engineering GmbH, Wolfsburg
- > Dr. Ing. h.c. F. Porsche AG, Stuttgart
- > Haberl Beteiligungs-GmbH, Munich
- > Karosseriewerk Porsche GmbH & Co. KG, Stuttgart
- > MAHAG GmbH, Munich
- > Porsche Consulting GmbH, Bietigheim-Bissingen
- > Porsche Deutschland GmbH, Bietigheim-Bissingen
- > Porsche Dienstleistungs GmbH, Stuttgart
- > Porsche Engineering Group GmbH, Weissach
- > Porsche Engineering Services GmbH, Bietigheim-Bissingen
- > Porsche Financial Services GmbH & Co. KG, Bietigheim-Bissingen
- > Porsche Financial Services GmbH, Bietigheim-Bissingen
- > Porsche Holding Stuttgart GmbH, Stuttgart
- > Porsche Leipzig GmbH, Leipzig
- > Porsche Lizenz- und Handelsgesellschaft mbH & Co. KG, Bietigheim-Bissingen
- > Porsche Logistik GmbH, Stuttgart
- > Porsche Niederlassung Berlin GmbH, Berlin
- > Porsche Niederlassung Berlin-Potsdam GmbH, Kleinmachnow
- > Porsche Niederlassung Hamburg GmbH, Hamburg
- > Porsche Niederlassung Leipzig GmbH, Leipzig
- > Porsche Niederlassung Mannheim GmbH, Mannheim
- > Porsche Niederlassung Stuttgart GmbH, Stuttgart
- > Porsche Nordamerika Holding GmbH, Ludwigsburg
- > Porsche Siebte Vermögensverwaltung GmbH, Stuttgart
- > Porsche Zentrum Hoppegarten GmbH, Stuttgart
- > quattro GmbH, Neckarsulm
- > Raffay Versicherungsdienst GmbH, Hamburg
- > Truck & Bus GmbH, Wolfsburg
- > VfL Wolfsburg-Fußball GmbH, Wolfsburg
- > VGRD GmbH, Wolfsburg
- > Volim Volkswagen Immobilien Vermietgesellschaft für VW-/Audi-Händlerbetriebe mbH, Braunschweig
- > Volkswagen Automobile Berlin GmbH, Berlin
- > Volkswagen Automobile Frankfurt GmbH, Frankfurt am Main
- > Volkswagen Automobile Hamburg GmbH, Hamburg
- > Volkswagen Automobile Stuttgart GmbH, Stuttgart
- > Volkswagen Financial Services Beteiligungsgesellschaft mbH, Braunschweig
- > Volkswagen Gebrauchtfahrzeughandels und Service GmbH, Langenhagen

- > Volkswagen Group Real Estate GmbH & Co. KG, Wolfsburg
- > Volkswagen Immobilien GmbH, Wolfsburg
- > Volkswagen Logistics GmbH & Co. OHG, Wolfsburg
- > Volkswagen Original Teile Logistik GmbH & Co. KG, Baunatal
- > Volkswagen Osnabrück GmbH, Osnabrück
- > Volkswagen R GmbH, Wolfsburg
- > Volkswagen Sachsen GmbH, Zwickau
- > Volkswagen Versicherungsvermittlung GmbH, Braunschweig
- > Volkswagen Vertriebsbetreuungsgesellschaft mbH, Chemnitz
- > Volkswagen Zubehör GmbH, Dreieich
- > Volkswagen-Versicherungsdienst GmbH, Braunschweig
- > Volkswagen Automobile Chemnitz GmbH, Chemnitz
- > Volkswagen Automobile Hannover GmbH, Hannover
- > VOLKSWAGEN Automobile Leipzig GmbH, Leipzig
- > Volkswagen Automobile Region Hannover GmbH, Hannover
- > Volkswagen Automobile Rhein-Neckar GmbH, Mannheim

#### CONSOLIDATED SUBSIDIARIES

On August 1, 2012, Porsche Automobil Holding SE, Stuttgart (Porsche SE), contributed its holding company operating business to Volkswagen AG by way of singular succession in the course of a capital increase with a mixed noncash contribution.

The business acquired from Porsche SE consists in particular of the 50.1% interest held by Porsche SE in Porsche Holding Stuttgart GmbH, Stuttgart (Porsche Holding Stuttgart) (formerly: Porsche Zweite Zwischenholding GmbH, Stuttgart, as the legal successor to Porsche Zwischenholding GmbH, Stuttgart), and thus indirectly in Dr. Ing. h.c. F. Porsche AG, Stuttgart (Porsche AG), and of all other subsidiaries of Porsche SE existing at the contribution date (with the exception of the interest in Volkswagen AG), as well as receivables from and liabilities to companies of the Porsche Holding Stuttgart Group.

With unit sales of 117 thousand vehicles, premium sports car manufacturer Porsche AG generated sales revenue of €10,928 million and profit before tax of €2,108 million in fiscal year 2011. The integration of Porsche allows the Volkswagen Group to expand its product portfolio in the premium segment.

Volkswagen AG increased its share capital by €2.56 by issuing one new ordinary bearer share and allowed Porsche SE to subscribe for this new share; the preemptive rights of the other shareholders were disapplied. Volkswagen AG paid €4,495 million to Porsche SE as further consideration. The cash consideration is based on the equity value of €3,883 million for the remaining 50.1% interest in Porsche Holding Stuttgart (and thus indirectly in Porsche AG) held by Porsche SE set out in the Comprehensive Agreement, and also comprises a number of adjustment items. Among other things, Porsche SE will be remunerated for dividend payments from its indirect interest in Porsche AG that it would have received as well as for half of the present value of the net synergies realizable as a result of the accelerated integration, which amount to a total of approximately €320 million.

Based on the updated assumptions underlying the valuation at the acquisition date, Volkswagen AG's call option on the shares of Porsche Holding Stuttgart agreed in the Comprehensive Agreement with Porsche SE has a positive fair value of €10,199 million (December 31, 2011: €8,409 million) and the corresponding put option has a negative fair value of €2 million (December 31, 2011: €87 million). The fair values of the options are included in the cost of the business combination. The difference attributable to the updated fair values amounting to €1,875 million was recognized in the other financial result.

The shares of Porsche Holding Stuttgart, which were accounted for using the equity method at the acquisition date, were revalued at their fair value of €12,566 million on acquisition of the remaining shares. Measurement of the shares uses the same assumptions that were also used to measure the options on the outstanding shares of Porsche Holding Stuttgart and is based on Porsche Holding Stuttgart's business plans. The transition from the equity method to consolidation resulted in a noncash book gain of €10,399 million, which was recognized in the share of profits and losses of equity-accounted investments; this includes amounts totaling €-316 million that were previously recognized directly in equity and that were transferred to the income statement.

The measurement basis for the goodwill is calculated as follows:

€ million	2012
Purchase price for shares acquired on August 1	4,495
Fair value of options on the outstanding shares	10,197
Fair value of existing shares	12,566
Issued ordinary share of Volkswagen AG	0
<b>Measurement basis for goodwill</b>	<b>27,258</b>

The costs incurred in connection with the issue of the new ordinary share reduced the capital reserves by €1 million, net of deferred taxes. The other transaction-related costs incurred to date of €3 million were recognized as expenses.

After adjustment to reflect the application of IAS 19R, the business combination generated goodwill of €18,825 million (originally €18,871 million). The goodwill is not tax-deductible.

The following table shows the final allocation of the purchase price to the assets and liabilities after adjustment to reflect the application of IAS 19R:

€ million	Acquisition date IFRS carrying amounts	Purchase price allocation	Adjustment in the measurement period	Acquisition date fair values
Brand names	–	13,823	–	13,823
Technology	1,489	2,203	–	2,203
Customer and dealer relationships	–	691	–	691
Other intangible assets*	386	489	–	489
Property, plant and equipment	2,983	3,548	–	3,548
Investments	162	160	–	160
Leasing and rental assets	1,360	1,425	–	1,425
Other noncurrent assets	7,458	7,941	–20	7,921
Inventories	1,243	1,625	–	1,625
Trade receivables	348	348	–	348
Cash and cash equivalents	1,812	1,812	–	1,812
Other current assets	3,060	3,256	–	3,256
<b>Total assets</b>	<b>20,301</b>	<b>37,321</b>	<b>–</b>	<b>37,301</b>
Noncurrent financial liabilities	10,227	9,654	–	9,654
Other noncurrent liabilities and provisions	3,152	8,516	–59	8,457
Current financial liabilities	3,211	4,142	–	4,142
Trade payables	989	1,112	–	1,112
Current provisions	1,237	1,308	–7	1,301
Other current liabilities	4,160	4,203	–	4,203
<b>Total liabilities</b>	<b>22,977</b>	<b>28,934</b>	<b>–</b>	<b>28,868</b>

\* Excluding goodwill of Volkswagen AG.



The goodwill and the brand name are allocated to the Porsche operating segment.

The gross carrying amount of the receivables acquired was €9,858 million at the acquisition date, and the net carrying amount (equivalent to the fair value) was €9,775 million. Of this total, gross carrying amounts of €6,449 million (net carrying amounts: €6,449 million) are attributable to acquired loans and gross carrying amounts of €1,202 million (net carrying amounts: €1,127 million) are attributable to acquired finance lease receivables. The depreciable noncurrent assets have remaining useful lives of between 4 months and 50 years.

As of December 31, 2012, the inclusion of the company increased the Group's sales revenue by €4,534 million and increased its profit after tax, net of write-downs of hidden reserves identified in the course of purchase price allocation, by €292 million. If Porsche had been included as of January 1, 2012, the Group's sales revenue after consolidation as of December 31, 2012 would have been approximately €6,208 million higher and its profit after tax, net of write-downs of hidden reserves identified in the course of purchase price allocation, would have been approximately €656 million higher.

The contribution of Porsche SE's holding company operating business increases the consolidated Group by 107 consolidated subsidiaries.

As of July 19, 2012, the Volkswagen Group acquired 100% of the voting rights of motorcycle manufacturer Ducati Motor Holding S.p.A., Bologna, Italy, against payment of a purchase price of €747 million, via Automobili Lamborghini S.p.A., Sant'Agata Bolognese, Italy, a subsidiary of AUDI AG. The acquisition of Ducati – a leading international manufacturer of premium motorcycles with significant expertise in high-performance engines and lightweight construction – has seen the Group move into the growth market for high-quality motorcycles. The analysis of the assets acquired and liabilities assumed was completed in fiscal year 2013. There was no requirement to adjust the initial accounting in 2012 for this business combination.

The goodwill determined in the amount of €290 million contains intangible assets that are not separable and that cannot be attributed to contractual or other rights, such as the expertise of Ducati's employees. The goodwill is not tax-deductible. The transaction-related costs incurred to date of €1 million were recognized as expenses.

The following table shows the final allocation of the purchase price to the assets and liabilities:

€ million	Acquisition date IFRS carrying amounts	Purchase price allocation	Acquisition date fair values
Brand names	211	193	404
Customer relationships	49	131	180
Other intangible assets	78	17	95
Land and buildings	78	3	81
Other noncurrent assets	25	8	33
Inventories	83	0	83
Cash and cash equivalents	150	–	150
Other current assets	154	–	154
<b>Total assets</b>	<b>828</b>	<b>352</b>	<b>1,180</b>
Noncurrent liabilities	106	108	214
Current liabilities	510	–	510
<b>Total liabilities</b>	<b>616</b>	<b>108</b>	<b>724</b>

The gross carrying amount of the receivables acquired was €153 million at the acquisition date, and the net carrying amount (equivalent to the fair value) was €142 million.

As of December 31, 2012, the inclusion of the company increased the Group's sales revenue by €209 million and reduced its profit, net of write-downs of hidden reserves identified in the course of purchase price allocation, by €27 million. If Ducati had been included in the consolidated financial statements as of January 1, 2012, the Group's sales revenue after consolidation as of December 31, 2012 would have been approximately €422 million higher and its profit after tax, net of write-downs of hidden reserves identified in the course of purchase price allocation, would have been approximately €34 million higher.

In order to strengthen its sales activities, Volkswagen acquired all shares of KPI Polska Sp.z o.o., Poznan (KPI Polska), effective January 1, 2012. KPI Polska is the exclusive importer and distributor of various Volkswagen Group brands in Poland. At the same time, Volkswagen acquired from the previous owners of KPI Polska the outstanding shares of the former jointly controlled companies Volkswagen Leasing Polska Sp.z o.o., Warsaw, and Volkswagen Bank Polska S.A., Warsaw. The purchase price paid amounted to €254 million in total. The measurement of the existing shares in the financial services companies at a fair value of €66 million resulted in a noncash book gain of €21 million, which was recognized in the share of profits and losses of equity-accounted investments.

In addition, on March 28, 2012, the Volkswagen Group acquired through MAN Truck & Bus AG, Munich, the remaining shares (apart from one share) of MAN TRUCKS India Private Limited, Akurdi/India (formerly: MAN FORCE TRUCKS Private Limited, Akurdi/India), which until then had been a joint venture, against payment of €150 million. The company has been consolidated since that date. MAN TRUCKS India produces CLA series heavy MAN trucks for the Indian market and for export to Asian and African countries. The shares, which were accounted for using the equity method at the acquisition date, were recognized at their acquisition-date fair value of €73 million. This resulted in a noncash book loss of €37 million, which was recognized in the share of profits and losses of equity-accounted investments. The measurement basis for the goodwill from the two transactions is calculated as follows:

€ million	2012
Purchase price for shares acquired	404
Fair value of existing shares	139
<b>Measurement basis for goodwill</b>	<b>543</b>

Transaction-related costs of €3.5 million were recognized directly as expenses.

The following main groups of assets and liabilities were finally acquired and assumed for KPI Polska, the Polish financial services companies and MAN TRUCKS India:

€ million	Acquisition date IFRS carrying amounts	Purchase price allocation	Acquisition date fair values
Noncurrent assets	326	100	427
Cash and cash equivalents	74	–	74
Other current assets	637	–	637
<b>Total assets</b>	<b>1,037</b>	<b>100</b>	<b>1,137</b>
Noncurrent liabilities	192	28	220
Current liabilities	668	–	668
<b>Total liabilities</b>	<b>860</b>	<b>28</b>	<b>888</b>

The gross carrying amount of the receivables was €708 million at the acquisition date, and the net carrying amount (equivalent to the fair value) was €668 million. The depreciable noncurrent assets have remaining useful lives of between 24 months and 40 years.

The goodwill from the acquisition of KPI Polska amounts to €58 million and is allocated to the Volkswagen Passenger Cars operating segment. The goodwill of €28 million attributable to the Polish financial services companies is allocated to the Volkswagen Financial Services operating segment, which is part of the Financial Services reporting segment. The goodwill from the acquisition of MAN TRUCKS India amounts to €208 million and is allocated to the MAN Commercial Vehicles operating segment, which is part of the Commercial Vehicles reporting segment. The goodwill from the acquisitions is not tax-deductible.

The initial inclusion of the abovementioned companies had no material effect on the Volkswagen Group's sales revenue and profit after tax.

The abovementioned fair values of the assets and liabilities were determined as far as possible using observable market prices. If market prices could not be determined, recognized valuation techniques were used to measure the assets acquired and liabilities assumed.

Following its approval by the Annual General Meeting of MAN SE on June 6, 2013 and its entry in the commercial register on July 16, 2013, the control and profit and loss transfer agreement in accordance with section 291 of the Aktiengesetz (AktG – German Stock Corporation Act) between MAN SE, as the controlled company, and Truck & Bus GmbH, a wholly owned subsidiary of Volkswagen AG, as the controlling company, entered into force. The obligation to transfer profits is effective as of the fiscal year beginning on January 1, 2014; the obligation to absorb losses is effective for the first time as of fiscal year 2013.

The agreement sets out that the noncontrolling interest shareholders of MAN SE are entitled to either a cash settlement in accordance with section 305 of the AktG amounting to €80.89 per tendered ordinary or preferred share, or cash compensation in accordance with section 304 of the AktG in the amount of €3.07 per ordinary or preferred share (after corporate taxes, before the shareholder's individual tax liability) for each full fiscal year. For the current fiscal year, Truck & Bus GmbH is guaranteeing the noncontrolling interest shareholders of MAN SE a minimum dividend in line with the cash compensation.

Following the approval by the Annual General Meeting of MAN SE of the conclusion of the control and profit and loss transfer agreement, Volkswagen is no longer able to avoid its obligation to make a cash settlement. For this reason, the noncontrolling interests in the equity of MAN SE and the interest in Scania AB attributable to these noncontrolling interest shareholders, amounting to a total of €1,759 million, were derecognized from Group equity as of this date as a capital transaction involving a change in ownership interest. At the same time, a liability was recognized in accordance with the cash settlement offer for the obligation to acquire the shares in the amount of €3,125 million. The resulting difference of €1,366 million reduces the reserves attributable to the shareholders of Volkswagen AG. From now on, MAN SE's profit or loss will be attributed in full to the shareholders of Volkswagen AG. As of December 31, 2013, 289,665 ordinary shares and 88,643 preferred shares had been tendered.

Following the derecognition of the noncontrolling interests in the equity of MAN SE from Group equity, all shares of Scania AB that are held by MAN SE are attributable to the Volkswagen Group. The interest in the capital of Scania AB attributable to the shareholders of Volkswagen AG has increased to 62.64% (December 31, 2012: 59.13%).

In July 2013, Truck & Bus GmbH, a wholly owned subsidiary of Volkswagen AG, was served with an application in accordance with section 1 no. 1 of the Spruchverfahrensgesetz (SpruchG – German Award Proceedings Act) for judicial review of the appropriateness of the cash settlement in accordance with section 305 of the Aktiengesetz (AktG – German Stock Corporation Act) and the cash compensation in accordance with section 304 of the AktG for the noncontrolling interest shareholders of MAN SE attributable to the control and profit and loss transfer agreement between MAN SE and Truck & Bus GmbH, which was entered in MAN SE's commercial register on July 16, 2013. As a result of the opening of the award proceedings, the obligation to the noncontrolling interest shareholders must be reassessed and the expected present value of the minimum statutory interest rate in accordance with section 305 of the AktG must be recognized as a liability. Based on the assumption that the award proceedings will take seven years, the assessment resulted in an expense of €493 million, which was recognized in the other financial result. It is not currently possible to predict the exact duration of the proceedings.

The other changes in the basis of consolidation are shown in the following table:

Number	Germany	Abroad
<b>Initially consolidated</b>		
of which: subsidiaries previously carried at cost	9	24
of which: newly acquired subsidiaries	–	2
of which: newly formed subsidiaries	5	18
	<b>14</b>	<b>44</b>
<b>Deconsolidated</b>		
of which: mergers	7	3
of which: liquidations	5	11
of which: sales/other	–	1
	<b>12</b>	<b>15</b>

The initial inclusion of these subsidiaries, either individually or collectively, did not have a significant effect on the presentation of the net assets, financial position and results of operations.

#### INVESTMENTS IN ASSOCIATES

The acquisition of the majority interest in MAN SE in fiscal year 2011 meant that MAN's 30% interest in Ferrostaal GmbH (formerly: Ferrostaal AG), Essen, was attributable to Volkswagen. There was already an intention to sell the investment in the near term at the time it was acquired, so the shares were classified as held for sale and not accounted for using the equity method. The investment had already been written down in full as of December 31, 2011. On March 7, 2012, the settlement agreement between MAN SE and the International Petroleum Investment Company (IPIC), Abu Dhabi, regarding the repurchase of the 70% interest in Ferrostaal held by IPIC was completed (settlement with IPIC).

In fiscal year 2012, this resulted in a cash outflow of €350 million, which is reported as part of the cash flows from operating activities.

At the same time, the agreement between MAN and MPC Industries GmbH, Hamburg, regarding the transfer of 100% of the shares of Ferrostaal to MPC and a co-investor was implemented (the MPC sale). The completion of the settlement with IPIC and the sale of MPC did not result in any earnings effects for Volkswagen because the earnings effects attributable to the transaction had already been included in purchase price allocation for the MAN Group as a contingent liability.

In fiscal year 2013, the Volkswagen Group's profit after tax was primarily impacted in the amount of €276 million by income taxes and tax interest expenses attributable to the former income tax group between Ferrostaal and MAN SE.

The following carrying amounts are attributable to the Volkswagen Group from its proportionate interest in Sinotruk (Hong Kong) Limited, Hong Kong (Sinotruk), and Rheinmetall MAN Military Vehicles GmbH, Munich (RMMV):

€ million	SINOTRUK		RMMV	
	2013	2012	2013	2012
Equity interest (%)	25.0	25.0	49.0	49.0
Share of quoted market price	281	400	–	–
Assets <sup>1</sup>	1,440	1,499	224	184
Liabilities <sup>1</sup>	796	858	217	159
Sales revenue <sup>2</sup>	854	859	249	185
Profit/loss for the period <sup>2</sup>	8	8	–26	9

1 Amounts for Sinotruk refer to the June 30 reporting date and for RMMV to the September 30 reporting date.

2 Amounts for Sinotruk refer to the period from July 1 to June 30 and for RMMV to the period from October 1 to September 30.

#### INTERESTS IN JOINT VENTURES

The following carrying amounts are attributable ratably to the Volkswagen Group from its proportionate interest in joint ventures:

€ million	FAW-Volkswagen Automotive Company	Shanghai- Volkswagen Automotive Company	Global Mobility Holding	Porsche Holding Stuttgart*	Others	Total
<b>2013</b>						
Equity interest (%)	40.0	50.0	50.0	–	–	–
Noncurrent assets	2,090	2,512	5,407	–	2,664	12,674
Current assets	4,804	3,220	4,623	–	2,049	14,695
Noncurrent liabilities	645	475	3,577	–	1,238	5,935
Current liabilities	3,787	3,001	4,723	–	2,324	13,835
Income	15,794	10,448	599	–	2,985	29,826
Expenses	14,199	9,033	449	–	2,743	26,423
<b>2012</b>						
Equity interest (%)	40.0	50.0	50.0	49.9	–	–
Noncurrent assets	1,991	1,925	5,510	–	2,018	11,445
Current assets	3,828	2,807	4,714	–	1,666	13,015
Noncurrent liabilities	442	323	3,885	–	1,006	5,655
Current liabilities	2,961	2,486	4,690	–	1,723	11,861
Income	13,351	10,122	522	4,497	2,172	30,666
Expenses	11,834	9,065	401	4,069	1,959	27,328

\* Application of the equity method was terminated on August 1, 2012 when this company was fully consolidated. The disclosures on income and expenses for 2012 relate to the period up to July 31.

The Volkswagen Group holds a 50% indirect interest in the joint venture LeasePlan Corporation N.V., Amsterdam, the Netherlands, via its 50% stake in the joint venture Global Mobility Holding B.V., Amsterdam, the Netherlands. Volkswagen agreed with Fleet Investments B.V., Amsterdam, the Netherlands, an investment company belonging to the von Metzler family, that Fleet Investments would become the new co-investor in Global Mobility Holding in 2010. The previous co-investors were instructed by Volkswagen AG to transfer their shares to Fleet Investments B.V. on February 1, 2010 for the purchase price of €1.4 billion. In fiscal year 2013, the agreement was prolonged by a further two years until January 2016. Volkswagen AG has granted the new co-investor a put option on its shares. If this option is exercised, Volkswagen must pay the original purchase price plus accumulated pro rata preferred dividends or the higher fair value. The put option is accounted for at fair value.

In addition, Volkswagen has pledged claims under certificates of deposit with Bankhaus Metzler in the amount of €1.5 billion to secure a loan granted to Fleet Investments B.V. by Bankhaus Metzler. This pledge does not increase the Volkswagen Group's risk arising from the above-mentioned short position.

## Consolidation methods

The assets and liabilities of the German and foreign companies included in the consolidated financial statements are recognized in accordance with the uniform accounting policies used within the Volkswagen Group. In the case of companies accounted for using the equity method, the same accounting policies are applied to determine the proportionate equity, based on the most recent audited annual financial statements of each company.

In the case of subsidiaries consolidated for the first time, assets and liabilities are measured at their fair value at the date of acquisition. Their carrying amounts are adjusted in subsequent years. Goodwill arises when the purchase price of the investment exceeds the fair value of identifiable net assets. Goodwill is tested for impairment once a year to determine whether its carrying amount is recoverable. If the carrying amount of goodwill is higher than the recoverable amount, an impairment loss must be recognized. If this is not the case, there is no change in the carrying amount of goodwill compared with the previous year. If the purchase price of the investment is less than the identifiable net assets, the difference is recognized in the income statement in the year of acquisition. Goodwill is accounted for at the subsidiaries in the functional currency of those subsidiaries. Any difference that arises from the acquisition of additional shares of an already consolidated subsidiary is taken directly to equity. Unless otherwise stated, the proportionate equity directly attributable to noncontrolling interests is determined at the acquisition date as the share of the fair value of the assets (excluding goodwill) and liabilities attributable to them. Contingent consideration is measured at fair value at the acquisition date. Subsequent changes in the fair value of contingent consideration do not generally result in the adjustment of the acquisition-date measurement. Acquisition-related costs that are not equity transaction costs are not added to the purchase price, but instead recognized as expenses in the period in which they are incurred.

The consolidation process involves adjusting the items in the separate financial statements of the parent and its subsidiaries and presenting them as if they were those of a single economic entity. Intragroup assets, liabilities, equity, income, expenses and cash flows are eliminated in full. Intercompany profits or losses are eliminated in Group inventories and noncurrent assets. Deferred taxes are recognized for consolidation adjustments, and deferred tax assets and liabilities are offset where taxes are levied by the same tax authority and relate to the same tax period.

## Currency translation

Transactions in foreign currencies are translated in the single-entity financial statements of Volkswagen AG and its consolidated subsidiaries at the rates prevailing at the transaction date. Foreign currency monetary items are recorded in the balance sheet using the middle rate at the closing date. Foreign exchange gains and losses are recognized in the income statement. This does not apply to foreign exchange differences from loans receivable that represent part of a net investment in a foreign operation. The financial statements of foreign companies are translated into euros using the functional currency concept. Asset and liability items are translated at the closing rate. With the exception of income and expenses recognized directly in equity, equity is translated at historical rates. The resulting foreign exchange differences are recognized in other comprehensive income until disposal of the subsidiary concerned, and are presented as a separate item in equity.

Income statement items are translated into euros at weighted average rates.

The rates applied are presented in the following table:

	€1 =	BALANCE SHEET MIDDLE RATE ON DECEMBER 31,		INCOME STATEMENT AVERAGE RATE	
		2013	2012	2013	2012
Argentina	ARS	8.98251	6.48404	7.27413	5.84444
Australia	AUD	1.54230	1.27120	1.37702	1.24134
Brazil	BRL	3.25760	2.70360	2.86694	2.50970
Canada	CAD	1.46710	1.31370	1.36845	1.28479
Czech Republic	CZK	27.42700	25.15100	25.98715	25.14567
India	INR	85.36600	72.56000	77.87525	68.62947
Japan	JPY	144.72000	113.61000	129.65950	102.62121
Mexico	MXN	18.07310	17.18450	16.96444	16.90867
People's Republic of China	CNY	8.34910	8.22070	8.16549	8.10942
Poland	PLN	4.15430	4.07400	4.19708	4.18433
Republic of Korea	KRW	1,450.93000	1,406.23000	1,453.85601	1,448.19540
Russia	RUB	45.32460	40.32950	42.32482	39.92376
South Africa	ZAR	14.56600	11.17270	12.83079	10.55455
Sweden	SEK	8.85910	8.58200	8.65050	8.70672
United Kingdom	GBP	0.83370	0.81610	0.84925	0.81110
USA	USD	1.37910	1.31940	1.32814	1.28560

## Accounting policies

### MEASUREMENT PRINCIPLES

With certain exceptions such as financial instruments at fair value through profit or loss, available-for-sale financial assets and provisions for pensions and other post-employment benefits, items in the Volkswagen Group are accounted for under the historical cost convention. The methods used to measure the individual items are explained in more detail below.

### INTANGIBLE ASSETS

Purchased intangible assets are recognized at cost and amortized over their useful life using the straight-line method. This relates in particular to software, which is amortized over three years.

In accordance with IAS 38, research costs are recognized as expenses when incurred.

Development costs for future series products and other internally generated intangible assets are capitalized at cost, provided manufacture of the products is likely to bring the Volkswagen Group an economic benefit. If the criteria for recognition as assets are not met, the expenses are recognized in the income statement in the year in which they are incurred.

Capitalized development costs include all direct and indirect costs that are directly attributable to the development process. The costs are amortized using the straight-line method from the start of production over the expected life cycle of the models or powertrains developed – generally between two and ten years.

Amortization recognized during the year is allocated to the relevant functions in the income statement.

Brand names from business combinations usually have an indefinite useful life and are therefore not amortized. This is reviewed on a regular basis.

Goodwill, intangible assets with indefinite useful lives and intangible assets that are not yet available for use are tested for impairment at least once a year. Assets in use and other intangible assets with finite useful lives are tested for impairment only if there are specific indications that they may be impaired. The Volkswagen Group generally applies the higher of value in use and fair value less costs to sell of the relevant cash-generating unit (brands or products) to determine the recoverable amount of goodwill and indefinite-lived intangible assets. Measurement of value in use is based on management's current planning. This planning is based on expectations regarding future global economic trends and on assumptions derived from those trends about the markets for passenger cars and commercial vehicles, market shares and the profitability of the products. The planning for the Financial Services segment is prepared on the basis of these expectations, and also reflects the relevant market penetration rates and regulatory requirements. The planning for the Power Engineering segment reflects expectations about trends in the various individual markets. The planning includes reasonable assumptions about macroeconomic trends (exchange rate, interest rate and commodity price trends) and historical developments. The planning period generally covers five years. For information on the assumptions applied to the detailed planning period, please refer to the Report on Expected Developments, which is part of the Management Report. For subsequent years, plausible assumptions are made regarding future trends. The planning assumptions are adapted to reflect the current state of knowledge.

Estimation of cash flows is generally based on the expected growth trends for the markets concerned. The estimates for the cash flows following the end of the planning period are generally based on a growth rate of up to 1% p.a. (previous year: up to 1% p.a.) in the Passenger Cars and Financial Services segments, and on a growth rate of up to 2% p.a. (previous year: up to 2% p.a.) in the Power Engineering and Commercial Vehicles segments.



**CONSOLIDATED FINANCIAL STATEMENTS**  
Notes to the Consolidated Financial Statements

Value in use is determined for the purpose of impairment testing of goodwill, indefinite-lived intangible assets and finite-lived intangible assets – mainly capitalized development costs – using the following pretax weighted average cost of capital (WACC) rates (the prior-year figures shown now also use the corresponding pretax WACC rates), which are adjusted if necessary for country-specific discount factors:

WACC	2013	2012
Passenger Cars segment	6.6%	6.6%
Commercial Vehicles segment	11.2%	10.5%
Power Engineering segment	14.7%	11.1%

A cost of equity of 9.0% (previous year: 10.2%) is used for the Financial Services segment in line with the sector-specific need to reflect third-party borrowings. If necessary, this rate is additionally adjusted for country-specific discount factors.

The WACC rates are calculated based on a risk-free rate of interest. In addition to a market risk premium, specific peer group information on beta factors, leverage and cost of debt is also taken into account.

**PROPERTY, PLANT AND EQUIPMENT**

Property, plant and equipment is carried at cost less depreciation and – where necessary – write-downs for impairment. Investment grants are generally deducted from cost. Cost is determined on the basis of the direct and indirect costs that are directly attributable. Special tools are reported under other equipment, operating and office equipment. Property, plant and equipment is depreciated using the straight-line method over its estimated useful life. The useful lives of items of property, plant and equipment are reviewed at each balance sheet date and adjusted if required.

Depreciation is based mainly on the following useful lives:

	Useful life
Buildings	25 to 50 years
Site improvements	10 to 18 years
Technical equipment and machinery	6 to 12 years
Other equipment, operating and office equipment, including special tools	3 to 15 years

Impairment losses on property, plant and equipment are recognized in accordance with IAS 36 where the recoverable amount of the asset concerned has fallen below the carrying amount. Recoverable amount is the higher of value in use and fair value less costs to sell. Value in use is determined using the principles described for intangible assets. The discount rates for product-specific tools and investments are the same as the above-mentioned discount rates for capitalized development costs. If the reasons for impairments recognized in previous years no longer apply, the impairment losses are reversed up to a maximum of the amount that would have been determined if no impairment loss had been recognized.

In accordance with the principle of substance over form, assets that have been formally transferred to third parties under a sale and leaseback transaction including a repurchase option also continue to be accounted for as separate assets.

Where leased items of property, plant and equipment are used, the criteria for classification as a finance lease as set out in IAS 17 are met if all material risks and rewards incidental to ownership have been transferred to the Group company concerned. In such cases, the assets concerned are recognized at fair value or at the present value of the minimum lease payments (if lower) and depreciated using the straight-line method over the asset's useful life, or over the term of the lease if this is shorter. The payment obligations arising from the future lease payments are discounted and recorded as a liability in the balance sheet.

Where Group companies are the lessees of assets under operating leases, i.e. if not all material risks and rewards incidental to ownership are transferred, lease and rental payments are recorded directly as expenses in the income statement.

#### **LEASING AND RENTAL ASSETS**

Vehicles leased out under operating leases are recognized at cost and depreciated to their estimated residual value using the straight-line method over the term of the lease. Impairment losses identified as a result of an impairment test in accordance with IAS 36 are recognized and the depreciation rate is adjusted. The forecast residual values are adjusted to include constantly updated internal and external information on residual values, depending on specific local factors and the experiences gained in the marketing of used cars.

#### **INVESTMENT PROPERTY**

Real estate and buildings held in order to obtain rental income (investment property) are carried at amortized cost; the useful lives applied to depreciation generally correspond to those of the property, plant and equipment used by the Company itself. The fair value of investment property must be disclosed in the notes if it is carried at amortized cost. Fair value is generally estimated using an investment method based on internal calculations. This involves determining the income value for a specific building on the basis of gross income, taking into account additional factors such as land value, remaining useful life and a multiplier specific to property.

#### **CAPITALIZATION OF BORROWING COSTS**

Borrowing costs that are directly attributable to the acquisition of qualifying assets on or after January 1, 2009 are capitalized as part of the cost of these assets. A qualifying asset is an asset that necessarily takes at least a year to get ready for its intended use or sale.

#### **EQUITY-ACCOUNTED INVESTMENTS**

The cost of equity-accounted investments is adjusted to reflect the share of increases or reductions in equity at the associates and joint ventures after the acquisition that is attributable to the Volkswagen Group. Additionally, the investment is tested for impairment if there are indications of impairment and written down to the lower recoverable amount if necessary. Recoverable amount is determined using the principles described for indefinite-lived intangible assets. If the reason for impairment ceases to apply at a later date, the impairment loss is reversed to the carrying amount that would have been determined had no impairment loss been recognized.

#### **FINANCIAL INSTRUMENTS**

Financial instruments are contracts that give rise to a financial asset of one company and a financial liability or an equity instrument of another. Regular way purchases or sales of financial instruments are accounted for at the settlement date – that is, at the date on which the asset is delivered.

IAS 39 classifies financial assets into the following categories:

- > financial assets at fair value through profit or loss;
- > held-to-maturity financial assets;
- > loans and receivables; and
- > available-for-sale financial assets.

Financial liabilities are classified into the following categories:

- > financial liabilities at fair value through profit or loss; and
- > financial liabilities measured at amortized cost.

We recognize financial instruments at amortized cost or at fair value.

The amortized cost of a financial asset or liability is the amount:

- > at which a financial asset or liability is measured at initial recognition;
- > minus any principal repayments;
- > minus any write-down for impairment or uncollectibility;
- > plus or minus the cumulative amortization of any difference between the original amount and the amount repayable at maturity (premium, discount), amortized using the effective interest method over the term of the financial asset or liability.

In the case of current receivables and liabilities, amortized cost generally corresponds to the principal or repayment amount.

Fair value generally corresponds to the market or quoted market price. If no active market exists, fair value is determined using valuation techniques, such as by discounting the future cash flows at the market interest rate, or by using recognized option pricing models, and verified by confirmations from the banks that handle the transactions.

The fair value option is not used in the Volkswagen Group.

Financial assets and financial liabilities are generally presented at their gross amounts and only offset if the Volkswagen Group currently has a legally enforceable right to set off the amounts and intends either to settle on a net basis or to realize the asset and settle the liability simultaneously.

#### **LOANS AND RECEIVABLES AND FINANCIAL LIABILITIES**

Loans, receivables and liabilities, as well as held-to-maturity investments, are measured at amortized cost, unless hedged. Specifically, these relate to:

- > receivables from financing business;
- > trade receivables and payables;
- > other receivables and financial assets and liabilities;
- > financial liabilities; and
- > cash, cash equivalents and time deposits.

#### **AVAILABLE-FOR-SALE FINANCIAL ASSETS**

Available-for-sale financial assets are either allocated specifically to this category or are financial assets that cannot be assigned to any other category.

Available-for-sale financial assets (marketable securities) are carried at fair value. Changes in fair value are recognized directly in equity, net of deferred taxes.

Shares in unconsolidated subsidiaries and other equity investments that are not accounted for using the equity method are also classified as available-for-sale financial assets. They are recognized at cost in the consolidated financial statements if there is no active market for those companies and fair values cannot be reliably ascertained without undue cost or effort. Fair values are recognized if there are indications that fair value is lower than cost. There is currently no intention to sell these financial assets.

#### **DERIVATIVES AND HEDGE ACCOUNTING**

Volkswagen Group companies use derivatives to hedge balance sheet items and future cash flows (hedged items). Derivatives such as swaps, forward transactions and options are used as the primary hedging instruments. The criteria for the application of hedge accounting are that the hedging relationship between the hedged item and the hedging instrument is clearly documented and that the hedge is highly effective.

The accounting treatment of changes in the fair value of hedging instruments depends on the nature of the hedging relationship. In the case of hedges against the risk of change in the carrying amount of balance sheet items (fair value hedges), both the hedging instrument and the hedged risk portion of the hedged item are measured at fair value. Several risk portions of hedged items are grouped into a portfolio if appropriate. In the case of a fair value portfolio hedge, the changes in fair value are accounted for in the same way as for a fair value hedge of an individual underlying. Gains or losses from the remeasurement of hedging instruments and hedged items are recognized in profit or loss. In the case of hedges of future cash flows (cash flow hedges), the hedging instruments are also measured at fair value. Gains or losses from remeasurement of the effective portion of the derivative are initially recognized in the reserve for cash flow hedges directly in equity, and are only recognized in the income statement when the hedged item is recognized in profit or loss; the ineffective portion of a cash flow hedge is recognized immediately in profit or loss.

Derivatives used by the Volkswagen Group for financial management purposes to hedge against interest rate, foreign currency, commodity, or price risks, but that do not meet the strict hedge accounting criteria of IAS 39, are classified as financial assets or liabilities at fair value through profit or loss (also referred to below as “derivatives not included in hedging relationships”). This also applies to options on shares. External hedges of intragroup hedged items that are subsequently eliminated in the consolidated financial statements are also assigned to this category. Assets and liabilities measured at fair value through profit or loss consist of derivatives or components of derivatives that are not included in hedge accounting. These relate primarily to the interest component of currency forwards used to hedge sales revenue, commodity futures and currency forwards relating to commodity futures. Gains and losses from the remeasurement and settlement of financial instruments at fair value through profit or loss are reported in the financial result.

#### **RECEIVABLES FROM FINANCE LEASES**

Where a Group company is the lessor – generally of vehicles – a receivable in the amount of the net investment in the lease is recognized in the case of finance leases, in other words where substantially all the risks and rewards incidental to ownership are transferred to the lessee.

#### **OTHER RECEIVABLES AND FINANCIAL ASSETS**

Other receivables and financial assets (except for derivatives) are recognized at amortized cost.

#### **IMPAIRMENT LOSSES ON FINANCIAL INSTRUMENTS**

Default risk on loans and receivables in the financial services business is accounted for by recognizing specific valuation allowances and portfolio-based valuation allowances.

More specifically, in the case of significant individual receivables (e.g. dealer finance receivables and fleet customers) specific valuation allowances are recognized in accordance with Group-wide standards in the amount of the incurred loss. A potential impairment is assumed in the case of a number of situations such as delayed payment over a certain period, the institution of enforcement measures, the threat of insolvency or overindebtedness, application for or the opening of bankruptcy proceedings, or the failure of reorganization measures.

Portfolio-based valuation allowances are recognized by grouping together insignificant receivables and significant individual receivables for which there is no indication of impairment into homogeneous portfolios on the basis of comparable credit risk features and allocating them by risk class. As long as no definite information is available as to which receivables are in default, average historical default probabilities for the portfolio concerned are used to calculate the amount of the valuation allowances.

As a matter of principle, specific valuation allowances are recognized on receivables outside the Financial Services segment.

Valuation allowances on receivables are regularly recognized in separate allowance accounts.

An impairment loss is recognized on available-for-sale financial assets if there is objective evidence of permanent impairment. In the case of equity instruments, evidence of impairment is taken to exist, among other things, if the fair value decreases below cost significantly (by more than 20%) or the decrease is prolonged (by more than 10% of the average market prices over one year). If impairment is identified, the cumulative loss is recognized in the reserve and charged to profit and loss. In the case of equity instruments, reversals of impairment losses are taken directly to equity. Impairment losses are recognized on debt instruments if a decrease in the future cash flows of the financial asset is expected. An increase in the risk-free interest rate or an increase in credit risk premiums is not in itself evidence of impairment.

#### **DEFERRED TAXES**

Deferred tax assets are generally recognized for tax-deductible temporary differences between the tax base of assets and their carrying amounts in the consolidated balance sheet, as well as on tax loss carryforwards and tax credits provided it is probable that they can be used in future periods. Deferred tax liabilities are generally recognized for all taxable temporary differences between the tax base of liabilities and their carrying amounts in the consolidated balance sheet.

Deferred tax liabilities and assets are recognized in the amount of the expected tax liability or tax benefit, as appropriate, in subsequent fiscal years, based on the expected enacted tax rate at the time of realization. The tax consequences of dividend payments are not taken into account until the resolution on appropriation of earnings available for distribution has been adopted.

Deferred tax assets that are unlikely to be realized within a clearly predictable period are reduced by valuation allowances.

Deferred tax assets and deferred tax liabilities are offset where taxes are levied by the same taxation authority and relate to the same tax period.

#### **INVENTORIES**

Raw materials, consumables and supplies, merchandise, work in progress and self-produced finished goods reported in inventories are carried at the lower of cost or net realizable value. Cost is determined on the basis of the direct and indirect costs that are directly attributable. Borrowing costs are not capitalized. The measurement of same or similar inventories is generally based on the weighted average cost method.

#### **NONCURRENT ASSETS HELD FOR SALE AND DISCONTINUED OPERATIONS**

Under IFRS 5, noncurrent assets or groups of assets and liabilities (disposal groups) are classified as held for sale if their carrying amounts will be recovered principally through a sale transaction rather than through continuing use. Such assets are carried at the lower of their carrying amount and fair value less costs to sell, and are presented separately in current assets and liabilities in the balance sheet.

Discontinued operations are components of an entity that have either been disposed of or are classified as held for sale. The assets and liabilities of operations that are held for sale represent disposal groups that must be measured and reported using the same principles as noncurrent assets held for sale. The income and expenses from discontinued operations are presented in the income statement as "profit or loss from discontinued operations" below the profit or loss from continuing operations. Corresponding disposal gains or losses are contained in the profit or loss from discontinued operations. The prior-year figures in the income statement are adjusted accordingly.

#### **PENSION PROVISIONS**

The actuarial valuation of pension provisions is based on the projected unit credit method stipulated by IAS 19 for defined benefit plans. The valuation is not only based on pension payments and vested entitlements known at the balance sheet date, but also reflects future salary and pension trends, as well as experience-based staff turnover rates. Actuarial gains and losses are recognized directly in equity, net of deferred taxes.

#### **PROVISIONS FOR TAXES**

Tax provisions contain obligations resulting from current taxes. Deferred taxes are presented in separate items of the balance sheet and income statement.

#### **OTHER PROVISIONS**

In accordance with IAS 37, provisions are recognized where a present obligation exists to third parties as a result of a past event, where a future outflow of resources is probable and where a reliable estimate of that outflow can be made.

Provisions not resulting in an outflow of resources in the year immediately following are recognized at their settlement value discounted to the balance sheet date. Discounting is based on market interest rates. An average discount rate of 1.03% (previous year: 0.69%) was used in Germany. The settlement value also reflects cost increases expected at the balance sheet date.

Provisions are not offset against claims for reimbursement.

We recognize insurance contracts that form part of the insurance business in accordance with IFRS 4. Reinsurance acceptances are accounted for without any time delay in the year in which they arise. Provisions are generally recognized based on the cedants' contractual duties. Estimation techniques based on assumptions about future changes in claims are used to calculate the claims provision. Other technical provisions relate to the provision for cancellations and the provision for suspended vehicle insurance policies.

The share of the provisions attributable to reinsurers is calculated in accordance with the contractual agreements with the retrocessionaries and reported under other assets.

#### **LIABILITIES**

Noncurrent liabilities are recorded at amortized cost in the balance sheet. Differences between historical cost and the repayment amount are amortized using the effective interest method.

Liabilities to members of partnerships from puttable shares are recognized in the income statement at the present value of the redemption amount at the balance sheet date.

Liabilities under finance leases are carried at the present value of the lease payments.

Current liabilities are recognized at their repayment or settlement value.

#### **REVENUE AND EXPENSE RECOGNITION**

Sales revenue, interest and commission income from financial services and other operating income are recognized only when the relevant service has been rendered or the goods have been delivered, that is, when the risk has passed to the customer, the amount of sales revenue can be reliably determined and settlement of the amount can be assumed. Revenue is reported net of sales allowances (discounts, rebates, or customer bonuses). Sales revenue from financing and lease agreements is recognized using the effective interest method. If non-interest-bearing or low-interest vehicle financing arrangements are agreed, sales revenue is reduced by the interest benefits granted. Revenue from operating leases is recognized using the straight-line method over the term of the lease. Sales revenue from extended warranties or maintenance agreements is recognized when deliveries take place or services are rendered. In the case of prepayments, deferred income is recognized proportionately by reference to the costs expected to be incurred, based on experience. Revenue is recognized on a straight-line basis if there is insufficient experience. If the expected costs exceed the accrued sales revenue, a loss is recognized from these agreements.

If a contract comprises several separately identifiable components (multiple-element arrangements), these components are recognized separately in accordance with the principles outlined above.

Income from assets for which a Group company has a buy back obligation is recognized only when the assets have definitively left the Group. If a fixed repurchase price was agreed when the contract was entered into, the difference between the selling and repurchase price is recognized as income ratably over the term of the contract. Prior to that time, the assets are carried as inventories in the case of short contract terms and as leasing and rental assets in the case of long contract terms.

Cost of sales includes the costs incurred to generate the sales revenue and the cost of goods purchased for resale. This item also includes the costs of additions to warranty provisions. Research and development costs not eligible for capitalization in the period and amortization of development costs are likewise carried under cost of sales. Reflecting the presentation of interest and commission income in sales revenue, the interest and commission expenses attributable to the financial services business are presented in cost of sales.

Construction contracts are recognized using the percentage of completion (PoC) method, under which revenue and cost of sales are recognized by reference to the stage of completion at the end of the reporting period, based on the contract revenue agreed with the customer and the expected contract costs. As a rule, the stage of completion is determined as the proportion that contract costs incurred by the end of the reporting period bear to the estimated total contract costs (cost-to-cost method). In certain cases, in particular those involving innovative, complex contracts, the stage of completion is measured using contractually agreed milestones (milestone method). If the outcome of a construction contract cannot yet be estimated reliably, contract revenue is recognized only in the amount of the contract costs incurred to date (zero profit method). In the balance sheet, contract components whose revenue is recognized using the percentage of completion method are reported as trade receivables, net of prepayments received. Expected losses from construction contracts are recognized immediately in full as expenses by recognizing impairment losses on recognized contract assets, and additionally by recognizing provisions for amounts in excess of the impairment losses.

Dividend income is recognized on the date when the dividend is legally approved.

#### **GOVERNMENT GRANTS**

Government grants related to assets are deducted when arriving at the carrying amount of the asset and are recognized in profit or loss over the life of the depreciable asset as a reduced depreciation expense. Government grants related to income, i.e. that compensate the Group for expenses incurred, are recognized in profit or loss for the period in those items in which the expenses to be compensated by the grants are also recognized.

#### **ESTIMATES AND ASSUMPTIONS BY MANAGEMENT**

Preparation of the consolidated financial statements requires management to make certain estimates and assumptions that affect the reported amounts of assets and liabilities, and income and expenses, as well as the related disclosure of contingent assets and liabilities of the reporting period. The estimates and assumptions relate largely to the following matters:

The impairment testing of nonfinancial assets (especially goodwill, brand names and capitalized development costs) and equity-accounted investments, or investments accounted at cost, and the measurement of options on shares in companies that are not traded in an active market require assumptions about the future cash flows during the planning period, and possibly beyond it, as well as about the discount rate to be applied. The estimates made in order to separate cash flows mainly relate to future market shares, the growth in the respective markets and the profitability of the products. In addition, the recoverability of the Group's leasing and rental assets depends in particular on the residual value of the leased vehicles after expiration of the lease term, because this represents a significant portion of the expected cash flows. More detailed information on impairment tests and the measurement parameters used for those tests can be found in the explanations on the accounting policies for intangible assets.

If there are no observable market inputs, the fair values of assets acquired and liabilities assumed in a business combination are measured using recognized valuation techniques, such as the relief-from-royalty method or the residual method.

Impairment testing of financial assets requires estimates about the extent and probability of occurrence of future events. As far as possible, estimates are derived from past experience taking into account current market data as well as rating categories and scoring information. In the case of financial services receivables, both specific and portfolio-based valuation allowances are recognized. The more detailed balance sheet disclosures on IFRS 7 (Financial Instruments) contain an overview of these specific and portfolio-based valuation allowances.

Accounting for provisions is also based on estimates of the extent and probability of occurrence of future events, as well as estimates of the discount rate. As far as possible, these are also based on past experience or external opinions. In addition, the measurement of pension provisions depends on the estimated growth in plan assets. The assumptions underlying the measurement of pension provisions are contained in note 29. Actuarial gains and losses are recognized in other comprehensive income and do not affect profit or loss reported in the income statement. Any change in the estimates of the amount of other provisions is always recognized in profit or loss. The provisions are regularly adjusted to reflect new information obtained. The use of empirical values means that additional amounts must frequently be recognized for provisions, or that unused provisions are reversed. Reversals of provisions are recognized as other operating income, whereas expenses relating to the recognition of provisions are allocated directly to the functions. Warranty claims from sales transactions are calculated on the basis of losses to date, estimated future losses and the policy on ex gratia arrangements. This requires assumptions to be made about the nature and extent of future guarantee and ex gratia claims. Note 30 contains an overview of other provisions. For information on litigation, see also note 36.

Estimates of the useful life of finite-lived assets are based on past experience and are reviewed regularly. Where estimates are modified the residual useful life is adjusted and an impairment loss is recognized, if necessary.

Measuring deferred tax assets requires assumptions regarding future taxable income and the timing of the realization of deferred tax assets.

The estimates and assumptions are based on underlying assumptions that reflect the current state of available knowledge. Specifically, the expected future development of business was based on the circumstances known at the date of preparation of these consolidated financial statements and a realistic assessment of the future development of the global and sector-specific environment. Our estimates and assumptions remain subject to a high degree of uncertainty because future business developments are subject to uncertainties that in part cannot be influenced by the Group. This applies in particular to short- and medium-term cash flow forecasts and to the discount rates used.

Developments in this environment that differ from the assumptions and that cannot be influenced by management could result in amounts that differ from the original estimates. If actual developments differ from the expected developments, the underlying assumptions and, if necessary, the carrying amounts of the assets and liabilities affected are adjusted.

At 2.5%, global economic growth in the reporting period was slower than the prior-year figure of 2.6%. Our planning for 2014 is based on the assumption that the global economy will grow at a rather stronger pace than in 2013. As a result, from today's perspective, we are not expecting material adjustments in the following fiscal year in the carrying amounts of the assets and liabilities reported in the consolidated balance sheet.

Estimates and assumptions by management were based in particular on assumptions relating to the development of the general economic environment, the automotive markets and the legal environment. These and further assumptions are explained in detail in the Report on Expected Developments.



## Segment reporting

Segments are identified on the basis of the Volkswagen Group's internal management and reporting. In line with the Group's multibrand strategy, each of its brands is managed by its own board of management. The Group targets and requirements laid down by the Board of Management of Volkswagen AG or the Group Board of Management must be complied with to the extent permitted by law. Segment reporting comprises four reportable segments: Passenger Cars, Commercial Vehicles, Power Engineering and Financial Services. Due to a change to the internal management system as of January 1, 2013, light commercial vehicles are no longer allocated to the Passenger Cars and Light Commercial Vehicles segment, but are reported together with trucks and buses in the new Commercial Vehicles segment. The segment designations and prior-year figures were adjusted accordingly. The prior-year figures were also adjusted to reflect the application of IAS 19R.

The activities of the Passenger Cars segment cover the development of vehicles and engines, the production and sale of passenger cars, and the corresponding genuine parts business. As a rule, the Volkswagen Group's individual passenger car brands are combined on a consolidated basis into a single reportable segment.

The Commercial Vehicles segment primarily comprises the development, production and sale of light commercial vehicles, trucks and buses, the corresponding genuine parts business and related services.

The activities of the Power Engineering segment consist of the development and production of large-bore diesel engines, turbo compressors, industrial turbines and chemical reactor systems, as well as the production of gear units, propulsion components and testing systems.

The activities of the Financial Services segment comprise dealer and customer financing, leasing, banking and insurance activities, fleet management and mobility services.

Purchase price allocation for companies acquired is allocated directly to the corresponding segments.

The business of Porsche AG acquired in fiscal year 2012 is allocated to the Passenger Cars segment, with the exception of Porsche's financial services activities, which are presented in the Financial Services segment. The Ducati Group, which was also acquired in fiscal year 2012, is allocated to the Audi operating segment and is thus presented in the Passenger Cars reporting segment.

At Volkswagen, segment profit or loss is measured on the basis of operating profit or loss.

In the segment reporting, the share of the profits or losses of joint ventures is contained in the share of profits and losses of equity-accounted investments in the corresponding segments.

The reconciliation contains activities and other operations that by definition do not constitute segments. It also includes the unallocated Group financing activities. Consolidation adjustments between the segments are also contained in the reconciliation.

Investments in intangible assets, property, plant and equipment, and investment property are reported net of investments under finance leases.

As a matter of principle, business relationships between the companies within the segments of the Volkswagen Group are transacted at arm's length prices.

**CONSOLIDATED FINANCIAL STATEMENTS**  
Notes to the Consolidated Financial Statements

**REPORTING SEGMENTS 2012\***

€ million	Passenger Cars	Commercial Vehicles	Power Engineering	Financial Services	Total segments	Reconciliation	Volkswagen Group
Sales revenue from external customers	144,970	25,181	4,222	18,151	192,523	153	192,676
Intersegment sales revenue	9,891	4,837	12	1,703	16,443	-16,443	-
Total sales revenue	154,861	30,017	4,234	19,854	208,966	-16,290	192,676
Depreciation and amortization	7,210	2,293	508	3,053	13,065	-67	12,997
Impairment losses	75	17	0	102	194	3	197
Reversal of impairment losses	65	-	-	3	68	-8	60
Segment profit or loss (operating profit or loss)	10,401	784	162	1,585	12,931	-1,433	11,498
Share of profits and losses of equity-accounted investments	13,512	-93	4	37	13,460	108	13,568
Net interest income and other financial result	-496	-79	-4	-140	-719	1,140	421
Equity-accounted investments	4,906	446	22	299	5,673	1,636	7,309
Investments in intangible assets, property, plant and equipment, and investment property	12,033	1,288	181	222	13,725	-617	13,108

\* Figures adjusted.

**CONSOLIDATED FINANCIAL STATEMENTS**  
Notes to the Consolidated Financial Statements

**REPORTING SEGMENTS 2013**

€ million	Passenger Cars	Commercial Vehicles	Power Engineering	Financial Services	Total segments	Reconciliation	Volkswagen Group
Sales revenue from external customers	146,630	25,963	3,845	20,093	196,531	476	197,007
Intersegment sales revenue	10,418	5,113	6	1,911	17,448	-17,448	-
Total sales revenue	157,048	31,076	3,851	22,004	213,979	-16,972	197,007
Depreciation and amortization	8,212	2,103	384	3,798	14,497	-118	14,379
Impairment losses	207	0	0	118	325	4	329
Reversal of impairment losses	32	2	1	16	51	-	51
Segment profit or loss (operating profit or loss)	11,053	1,044	-250	1,863	13,711	-2,040	11,671
Share of profits and losses of equity-accounted investments	3,440	-44	5	76	3,477	111	3,588
Net interest income and other financial result	-1,281	-930	-2	27	-2,187	-644	-2,831
Equity-accounted investments	5,431	391	18	377	6,218	1,716	7,934
Investments in intangible assets, property, plant and equipment, and investment property	13,544	1,329	137	345	15,355	52	15,407

**CONSOLIDATED FINANCIAL STATEMENTS**  
Notes to the Consolidated Financial Statements

**RECONCILIATION**

€ million	2013	2012*
<b>Segment sales revenue</b>	<b>213,979</b>	<b>208,966</b>
Unallocated activities	1,319	963
Group financing	35	37
Consolidation	-18,326	-17,290
<b>Group sales revenue</b>	<b>197,007</b>	<b>192,676</b>
<b>Segment profit or loss (operating profit or loss)</b>	<b>13,711</b>	<b>12,931</b>
Unallocated activities	58	94
Group financing	-13	-25
Consolidation	-2,085	-1,502
<b>Operating profit</b>	<b>11,671</b>	<b>11,498</b>
<b>Financial result</b>	<b>757</b>	<b>13,989</b>
<b>Consolidated profit before tax</b>	<b>12,428</b>	<b>25,487</b>

\* Prior-year figures adjusted.

**BY REGION 2012<sup>1</sup>**

€ million	Germany	Europe and Other Regions <sup>2</sup>	North America	South America	Asia- Pacific	Total
Sales revenue from external customers	37,734	77,650	25,046	18,311	33,936	192,676
Intangible assets, property, plant and equipment, leasing and rental assets, and investment property	73,028	30,084	10,930	3,640	1,321	119,003

1 Figures adjusted.

2 Excluding Germany.

**BY REGION 2013**

€ million	Germany	Europe and Other Regions*	North America	South America	Asia- Pacific	Total
Sales revenue from external customers	37,714	79,348	27,434	17,495	35,016	197,007
Intangible assets, property, plant and equipment, leasing and rental assets, and investment property	75,138	30,755	13,728	3,230	1,467	124,318

\* Excluding Germany.

Allocation of sales revenue to the regions follows the destination principle.

## INCOME STATEMENT DISCLOSURES

### 1. Sales revenue

#### STRUCTURE OF GROUP SALES REVENUE

€ million	2013	2012
Vehicles	134,842	134,537
Genuine parts	13,564	12,070
Used vehicles and third-party products	8,973	7,735
Engines, powertrains and parts deliveries	8,441	8,990
Power Engineering	3,845	4,222
Motorcycles	452	148
Rental and leasing business	13,948	11,825
Interest and similar income	6,034	6,337
Other sales revenue	6,909	6,812
	<b>197,007</b>	<b>192,676</b>

For segment reporting purposes, the sales revenue of the Group is presented by segment and market.

Other sales revenue comprises revenue from workshop services, among other things.

Sales revenue from construction contracts amounted to €359 million (previous year: €969 million), mainly related to the Power Engineering segment.

### 2. Cost of sales

Cost of sales includes interest expenses of €1,948 million (previous year: €2,577 million) attributable to the financial services business. This item also includes impairment losses on intangible assets, property, plant and equipment, and leasing and rental assets in the amount of €346 million (previous year: €210 million). Impairment losses are based on updated impairment tests and reflect market and exchange rate risks in particular, as well as amended sales forecasts and reduced product life cycles.

Government grants related to income amounted to €307 million in the fiscal year (previous year: €225 million) and were generally allocated to the functions.

The prior-year figures were adjusted to reflect the application of IAS 19R.

### 3. Distribution expenses

Distribution expenses amounting to €19,655 million (previous year: €18,850 million) include nonstaff overheads and personnel costs, and depreciation and amortization applicable to the distribution function, as well as the costs of shipping, advertising and sales promotions. The prior-year figures were adjusted to reflect the application of IAS 19R.

#### 4. Administrative expenses

Administrative expenses of €6,888 million (previous year: €6,220 million) mainly include nonstaff overheads and personnel costs, as well as depreciation and amortization applicable to the administrative function. The prior-year figures were adjusted to reflect the application of IAS 19R.

#### 5. Other operating income

€ million	2013	2012*
Income from reversal of valuation allowances on receivables and other assets	547	687
Income from reversal of provisions and accruals	2,532	2,964
Income from foreign currency hedging derivatives	1,785	1,601
Income from foreign exchange gains	1,758	2,437
Income from sale of promotional material	256	193
Income from cost allocations	909	832
Income from investment property	17	65
Gains on asset disposals and the reversal of impairment losses	233	159
Miscellaneous other operating income	1,919	1,548
	<b>9,956</b>	<b>10,484</b>

\* Prior-year figures adjusted to reflect application of IAS 19R.

Foreign exchange gains mainly comprise gains from changes in exchange rates between the dates of recognition and payment of receivables and liabilities denominated in foreign currencies, as well as exchange rate gains resulting from measurement at the closing rate. Foreign exchange losses from these items are included in other operating expenses.

#### 6. Other operating expenses

€ million	2013	2012
Valuation allowances on receivables and other assets	1,442	1,386
Losses from foreign currency hedging derivatives	985	2,817
Foreign exchange losses	2,486	2,329
Expenses from cost allocations	408	155
Expenses for termination agreements	76	55
Losses on disposal of noncurrent assets	151	66
Miscellaneous other operating expenses	1,796	2,261
	<b>7,343</b>	<b>9,070</b>

## 7. Share of profits and losses of equity-accounted investments

€ million	2013	2012
Share of profits of equity-accounted investments	3,652	13,675
of which: from joint ventures	(3,635)	(13,658)
of which: from associates	(17)	(16)
Share of losses of equity-accounted investments	64	107
of which: from joint ventures	(6)	(42)
of which: from associates	(58)	(65)
	<b>3,588</b>	<b>13,568</b>

The share of profits and losses of equity-accounted investments in the previous year includes the amounts from the adjustment of the equity interest in Porsche Holding Stuttgart until July 31, 2012 as well as income of €10,399 million from discontinuing equity method accounting for Porsche Holding Stuttgart.

## 8. Finance costs

€ million	2013	2012*
Other interest and similar expenses	1,494	1,380
Interest cost included in lease payments	19	19
<b>Interest expenses</b>	<b>1,513</b>	<b>1,398</b>
Interest component of additions to pension provisions	752	760
Interest cost on other liabilities	101	387
<b>Interest cost on liabilities</b>	<b>853</b>	<b>1,147</b>
<b>Finance costs</b>	<b>2,366</b>	<b>2,546</b>

\* Prior-year figures adjusted to reflect application of IAS 19R.

## 9. Other financial result

€ million	2013	2012
Income from profit and loss transfer agreements	18	18
Cost of loss absorption	5	16
Other income from equity investments	69	55
Other expenses from equity investments	50	19
Income from marketable securities and loans*	147	113
Other interest and similar income	786	844
Gains and losses from remeasurement and impairment of financial instruments	-453	7
Gains and losses from fair value remeasurement of derivatives not included in hedging relationships	-546	2,071
Gains and losses on hedging relationships	-33	-107
<b>Other financial result</b>	<b>-465</b>	<b>2,967</b>

\* Including disposal gains/losses.

In the previous year, gains and losses from the fair value measurement of derivatives not included in hedging relationships included gains of €1,875 million from the remeasurement of the put and call options on the outstanding 50.1% of the shares of Porsche Holding Stuttgart. See note 42 Related party disclosures in accordance with IAS 24 for further information.

## 10. Income tax income/expense

### COMPONENTS OF TAX INCOME AND EXPENSE

€ million	2013	2012*
Current tax expense, Germany	2,505	2,360
Current tax expense, abroad	1,672	2,152
<b>Current tax expense</b>	<b>4,177</b>	<b>4,513</b>
of which prior-period expense	(278)	(19)
Income from reversal of tax provisions	-445	-317
<b>Current income tax expense</b>	<b>3,733</b>	<b>4,196</b>
Deferred tax income/expense, Germany	-334	-309
Deferred tax income/expense, abroad	-116	-280
<b>Deferred tax income</b>	<b>-449</b>	<b>-589</b>
<b>Income tax income/expense</b>	<b>3,283</b>	<b>3,606</b>

\* Prior-year figures adjusted to reflect application of IAS 19R.

The statutory corporation tax rate in Germany for the 2013 assessment period was 15%. Including trade tax and the solidarity surcharge, this resulted in an aggregate tax rate of 29.5%.

A tax rate of 29.8% (previous year: 29.5%) was used to measure deferred taxes due to changes in the German consolidated tax group.

The local income tax rates applied for companies outside Germany vary between 0% and 41%. In the case of split tax rates, the tax rate applicable to undistributed profits is applied.

The realization of tax benefits from tax loss carryforwards from previous years resulted in a reduction in current income taxes in 2013 of €356 million (previous year: €319 million).



Previously unused tax loss carryforwards amounted to €11,164 million (previous year: €11,762 million). Tax loss carryforwards amounting to €9,070 million (previous year: €9,810 million) can be used indefinitely, while €442 million (previous year: €611 million) must be used within the next ten years. There are additional tax loss carryforwards amounting to €1,652 million (previous year: €1,341 million) that can be used within a period of 15 or 20 years. Tax loss carryforwards of €9,002 million (previous year: €9,885 million), of which €478 million (previous year €724 million) can only be utilized subject to restrictions within the next 20 years, were estimated not to be usable overall.

The benefit arising from previously unrecognized tax losses or tax credits of a prior period that is used to reduce current tax expense amounts to €247 million (previous year: €67 million). Deferred tax expense was reduced by €15 million (previous year: €37 million) because of a benefit arising from previously unrecognized tax losses and tax credits of a prior period. Deferred tax expense arising from the write-down of deferred tax assets amounts to €203 million (previous year: €342 million). Deferred tax income arising from the reversal of a write-down of a deferred tax asset amounts to €92 million (previous year: €1 million).

Tax benefits amounting to €785 million (previous year: €741 million) were recognized because of tax credits granted by various countries.

No deferred tax assets were recognized for deductible temporary differences of €620 million (previous year: €455 million) and for tax credits of €448 million (previous year: €409 million) that would expire in the next 20 years, or for tax credits of €103 million (previous year: €45 million) that will not expire.

Due to the change in the statutory provisions in Germany, a refund claim for corporation tax was recognized as a current tax asset for the first time in fiscal year 2006. The present value of the refund claim was €496 million at the balance sheet date (previous year: €600 million).

Deferred tax income resulting from changes in tax rates amounted to €94 million at Group level (previous year: €133 million).

Deferred taxes of €411 million (previous year: €437 million) were recognized without being offset by deferred tax liabilities in the same amount. The companies concerned expect positive tax income in future following losses in the fiscal year under review or in the previous year.

€1.394 million (previous year: €2,678 million) of the deferred taxes recognized in the balance sheet was credited to equity and relates to other comprehensive income. €31 million of this figure (previous year: €56 million) is attributable to noncontrolling interests. There were effects from capital transactions with noncontrolling interest shareholders in the reporting period and the prior-year period. Changes in deferred taxes classified by balance sheet item are presented on pages 170 and 171.

In the reporting period, tax effects of €58 million resulting from equity transaction costs were credited directly to the capital reserves.

Deferred taxes recognized directly in equity in the fiscal year are presented in detail in the statement of comprehensive income.

**CONSOLIDATED FINANCIAL STATEMENTS**  
*Notes to the Consolidated Financial Statements*

**DEFERRED TAXES CLASSIFIED BY BALANCE SHEET ITEM**

The following recognized deferred tax assets and liabilities were attributable to recognition and measurement differences in the individual balance sheet items and to tax loss carryforwards:

€ million	DEFERRED TAX ASSETS		DEFERRED TAX LIABILITIES	
	Dec. 31, 2013	Dec. 31, 2012	Dec. 31, 2013	Dec. 31, 2012
Intangible assets	249	218	9,216	9,140
Property, plant and equipment, and leasing and rental assets	3,782	3,578	5,229	4,904
Noncurrent financial assets	39	39	32	41
Inventories	1,825	1,601	650	598
Receivables and other assets (including Financial Services Division)	1,420	1,309	6,621	5,608
Other current assets	1,316	1,456	73	171
Pension provisions	3,592	4,063	241	257
Liabilities and other provisions	6,676	7,057	1,222	1,524
Tax loss carryforwards, net of valuation allowances	726	807	–	–
Tax credits, net of valuation allowances	230	285	–	–
Valuation allowances on other deferred tax assets	–278	–114	–	–
<b>Gross value</b>	<b>19,577</b>	<b>20,300</b>	<b>23,284</b>	<b>22,243</b>
of which noncurrent	(11,914)	(13,248)	(19,281)	(18,624)
Offset	15,539	13,339	15,539	13,339
Consolidation*	1,584	875	149	145
<b>Amount recognized</b>	<b>5,622</b>	<b>7,836</b>	<b>7,894</b>	<b>9,050</b>

\* Prior-year figures adjusted to reflect application of IAS 19R.

In accordance with IAS 12, deferred tax assets and liabilities are offset if, and only if, they relate to income taxes levied by the same taxation authority and relate to the same tax period.

The tax expense of €3,283 million reported for 2013 (previous year: €3,606 million) was €383 million (previous year: €3,913 million) lower than the expected tax expense of €3,666 million that would have resulted from application of a tax rate applicable to undistributed profits of 29.5% to the profit before tax of the Group.

#### RECONCILIATION OF EXPECTED TO EFFECTIVE INCOME TAX

€ million	2013	2012*
Profit before tax	12,428	25,487
<b>Expected income tax expense (tax rate 29.5%; previous year: 29.5%)</b>	<b>3,666</b>	<b>7,519</b>
Reconciliation:		
Effect of different tax rates outside Germany	-160	-101
Proportion of taxation relating to:		
tax-exempt income	-1,303	-1,131
expenses not deductible for tax purposes	379	345
effects of loss carryforwards and tax credits	-118	397
temporary differences for which no deferred taxes were recognized	303	-3,413
Tax credits	-86	-110
Prior-period tax expense	349	28
Effect of tax rate changes	-94	-133
Nondeductible withholding tax	273	229
Other taxation changes	74	-24
<b>Effective income tax expense</b>	<b>3,283</b>	<b>3,606</b>
Effective tax rate (%)	26.4	14.2

\* Prior-year figures adjusted to reflect application of IAS 19R.

The income and expenses reported in the “Other taxation changes” item in the previous years are presented in greater detail in fiscal year 2013. The prior-year figures were adjusted to reflect this change in presentation.

## 11. Earnings per share

Basic earnings per share are calculated by dividing profit attributable to Volkswagen AG shareholders by the weighted average number of ordinary and preferred shares outstanding during the reporting period. IAS 33.23 sets out that all potential shares that will be issued upon the conversion of a mandatory convertible note must be accounted for as issued shares and included in the calculation of basic and diluted earnings per share. The number of outstanding preferred shares is therefore increased by the potential preferred shares that would be issued if the mandatory convertible notes issued were actually to be converted. The average number of preferred shares not yet converted that have to be included is calculated based on the maximum conversion ratio resulting from the current minimum conversion price of €150.81. The terms and conditions required the minimum conversion price to be adjusted following the distribution of the dividend. The number of potential preferred shares was calculated retrospectively at the new minimum conversion price in accordance with IAS 33.26, including for the previous year. The finance costs associated with the mandatory convertible notes are not included in the calculation of consolidated profit because the interest component was recognized in other comprehensive income when the note was issued, and interest expense arises only from the amount of compound interest. Since the number of basic and diluted shares is identical, basic earnings per share also correspond to diluted earnings per share. In total, the existing mandatory convertible notes still entitle the holders to subscribe for a maximum of 24,527,551 no-par value preferred shares of Volkswagen AG.

**CONSOLIDATED FINANCIAL STATEMENTS**  
*Notes to the Consolidated Financial Statements*

See note 24 for further information regarding the issuance of the mandatory convertible note.

Quantity	ORDINARY		PREFERRED	
	2013	2012	2013	2012*
Weighted average number of shares outstanding – basic	295,089,818	295,089,818	191,006,646	172,537,076
Weighted average number of shares outstanding – diluted	295,089,818	295,089,818	191,006,646	172,537,076

\* Prior-year figures adjusted to reflect application of IAS 33.26.

€ million	2013	2012*
Profit after tax	9,145	21,881
Noncontrolling interests	52	169
Profit attributable to Volkswagen AG hybrid capital investors	27	0
Profit attributable to Volkswagen AG shareholders	9,066	21,712
Basic earnings attributable to ordinary shares	5,496	13,695
Diluted earnings attributable to ordinary shares	5,496	13,695
Basic earnings attributable to preferred shares	3,569	8,017
Diluted earnings attributable to preferred shares	3,569	8,017

\* Prior-year figures adjusted to reflect application of IAS 33.26 and IAS 19R.

€	2013	2012*
Basic earnings per ordinary share	18.63	46.41
Diluted earnings per ordinary share	18.63	46.41
Basic earnings per preferred share	18.69	46.47
Diluted earnings per preferred share	18.69	46.47

\* Prior-year figures adjusted to reflect application of IAS 33.26 and IAS 19R.

### Additional Income Statement Disclosures in Accordance with IAS 23 (Borrowing Costs)

Capitalized borrowing costs amounted to €74 million (previous year: €55 million) and related mainly to capitalized development costs. An average cost of debt of 2.4% (previous year: 3.0%) was used as a basis for capitalization in the Volkswagen Group.

### Additional Income Statement Disclosures in Accordance with IFRS 7 (Financial Instruments)

#### CLASSES OF FINANCIAL INSTRUMENTS

Financial instruments are divided into the following classes at the Volkswagen Group:

- > financial instruments measured at fair value,
- > financial instruments measured at amortized cost and
- > financial instruments not falling within the scope of IFRS 7.

Financial instruments not falling within the scope of IFRS 7 include in particular investments in associates and joint ventures accounted for using the equity method.

#### NET GAINS OR LOSSES FROM FINANCIAL INSTRUMENTS BY IAS 39 MEASUREMENT CATEGORY

€ million	2013	2012
Financial instruments at fair value through profit or loss	-756	1,868
Loans and receivables	3,386	4,855
Available-for-sale financial assets	193	256
Financial liabilities measured at amortized cost	-3,851	-3,992
	<b>-1,027</b>	<b>2,988</b>

Net gains and losses from financial assets and liabilities at fair value through profit or loss are composed of the fair value measurement gains and losses on derivatives, including interest and gains and losses on currency translation.

Net gains and losses from available-for-sale financial assets primarily comprise income and expenses from marketable securities including disposal gains/losses, impairment losses on investments and currency translation effects.

Net gains and losses from loans and receivables and from financial liabilities carried at amortized cost comprise interest income and expenses in accordance with the effective interest method under IAS 39, including currency translation effects. Interest also includes interest income and expenses from the lending business of the financial services operations.

**CONSOLIDATED FINANCIAL STATEMENTS**  
*Notes to the Consolidated Financial Statements*

**TOTAL INTEREST INCOME AND EXPENSES ATTRIBUTABLE TO FINANCIAL INSTRUMENTS NOT MEASURED AT FAIR VALUE THROUGH PROFIT OR LOSS**

€ million	2013	2012
Interest income	4,925	5,144
Interest expenses	3,981	3,747
	<b>943</b>	<b>1,396</b>

**IMPAIRMENT LOSSES ON FINANCIAL ASSETS BY CLASS**

€ million	2013	2012
Measured at fair value	2	6
Measured at amortized cost	1,470	1,403
	<b>1,472</b>	<b>1,409</b>

Impairment losses relate to write-downs of financial assets, such as valuation allowances on receivables, marketable securities and unconsolidated subsidiaries. Interest income on impaired financial assets amounted to €47 million in the fiscal year (previous year: €63 million).

In fiscal year 2013, €5 million (previous year: €4 million) was recognized as an expense and €52 million (previous year: €49 million) as income from fees and commissions for trust activities and from financial assets and liabilities not measured at fair value that are not accounted for using the effective interest method.

## BALANCE SHEET DISCLOSURES

### 12. Intangible assets

#### CHANGES IN INTANGIBLE ASSETS IN THE PERIOD JANUARY 1 TO DECEMBER 31, 2012

€ million	Brand name	Goodwill*	Capitalized development costs for products under development	Capitalized development costs for products currently in use	Other intangible assets	Total*
<b>Cost</b>						
<b>Balance at Jan. 1, 2012</b>	<b>2,857</b>	<b>4,334</b>	<b>2,696</b>	<b>14,425</b>	<b>6,937</b>	<b>31,248</b>
Foreign exchange differences	40	130	-3	25	-109	83
Changes in consolidated Group	14,239	19,425	1,017	1,254	1,524	37,459
Additions	-	-	2,174	441	379	2,994
Transfers	-	-	-2,229	2,244	-14	1
Disposals	-	-	29	965	277	1,271
<b>Balance at Dec. 31, 2012</b>	<b>17,135</b>	<b>23,889</b>	<b>3,627</b>	<b>17,422</b>	<b>8,441</b>	<b>70,513</b>
<b>Amortization and impairment</b>						
<b>Balance at Jan. 1, 2012</b>	<b>42</b>	<b>-</b>	<b>61</b>	<b>7,146</b>	<b>1,824</b>	<b>9,073</b>
Foreign exchange differences	-1	0	0	16	-9	7
Changes in consolidated Group	0	0	-	0	18	18
Additions to cumulative amortization	14	-	2	1,910	1,591	3,517
Additions to cumulative impairment losses	-	-	1	38	3	42
Transfers	-	-	-17	17	3	3
Disposals	-	-	-	939	271	1,210
Reversal of impairment losses	-	-	20	28	0	48
<b>Balance at Dec. 31, 2012</b>	<b>56</b>	<b>0</b>	<b>27</b>	<b>8,160</b>	<b>3,158</b>	<b>11,401</b>
<b>Carrying amount at Dec. 31, 2012</b>	<b>17,079</b>	<b>23,889</b>	<b>3,599</b>	<b>9,262</b>	<b>5,282</b>	<b>59,112</b>

\* Figures adjusted because of the updated purchase price allocation for MAN and to reflect application of IAS 19R.

Other intangible assets comprise in particular concessions, purchased customer lists and dealer relationships, industrial and similar rights, and licenses in such rights and assets.

Sensitivity analyses have shown that it is unnecessary to recognize impairment losses on goodwill and other indefinite-lived intangible assets, including where realistic variations are applied to key assumptions.

**CONSOLIDATED FINANCIAL STATEMENTS**  
Notes to the Consolidated Financial Statements

**CHANGES IN INTANGIBLE ASSETS IN THE PERIOD JANUARY 1 TO DECEMBER 31, 2013**

€ million	Brand name	Goodwill	Capitalized development costs for products under development	Capitalized development costs for products currently in use	Other intangible assets	Total
<b>Cost</b>						
<b>Balance at Jan. 1, 2013</b>	<b>17,135</b>	<b>23,889</b>	<b>3,627</b>	<b>17,422</b>	<b>8,441</b>	<b>70,513</b>
Foreign exchange differences	-42	-177	-66	-263	-270	-818
Changes in consolidated Group	-	18	-	-	38	57
Additions	-	-	3,390	631	351	4,373
Transfers	-5	-	-1,850	1,856	-23	-22
Disposals	0	-	15	422	185	622
<b>Balance at Dec. 31, 2013</b>	<b>17,088</b>	<b>23,730</b>	<b>5,087</b>	<b>19,224</b>	<b>8,352</b>	<b>73,481</b>
<b>Amortization and impairment</b>						
<b>Balance at Jan. 1, 2013</b>	<b>56</b>	<b>0</b>	<b>27</b>	<b>8,160</b>	<b>3,158</b>	<b>11,401</b>
Foreign exchange differences	-6	0	0	-156	-132	-294
Changes in consolidated Group	-	0	-	-	5	5
Additions to cumulative amortization	13	-	1	2,378	1,197	3,589
Additions to cumulative impairment losses	-	-	-	85	10	96
Transfers	-4	-	-4	9	-1	0
Disposals	-	-	-	392	168	560
Reversal of impairment losses	-	-	-	-	-	-
<b>Balance at Dec. 31, 2013</b>	<b>59</b>	<b>0</b>	<b>24</b>	<b>10,085</b>	<b>4,070</b>	<b>14,238</b>
<b>Carrying amount at Dec. 31, 2013</b>	<b>17,029</b>	<b>23,730</b>	<b>5,063</b>	<b>9,139</b>	<b>4,282</b>	<b>59,243</b>



**CONSOLIDATED FINANCIAL STATEMENTS**  
Notes to the Consolidated Financial Statements

The allocation of the brand name and goodwill to the operating segments is shown in the following table:

€ million	2013	2012
<b>Brand name by operating segments</b>		
Porsche	13,823	13,823
Scania Vehicles and Services	1,098	1,134
MAN Commercial Vehicles	1,135	1,145
MAN Power Engineering	470	470
Ducati	404	404
Other	99	104
	<b>17,029</b>	<b>17,079</b>
<b>Goodwill by operating segments</b>		
Porsche*	18,825	18,825
Scania Vehicles and Services	3,158	3,260
MAN Commercial Vehicles	651	708
Ducati	290	290
MAN Power Engineering	256	257
ŠKODA	148	161
Porsche Holding Salzburg	181	153
Other	221	234
	<b>23,730</b>	<b>23,889</b>

\* Prior-year figures adjusted to reflect application of IAS 19R.

The recoverability test for recognized goodwill is based on value in use and is not affected by a variation in the growth forecast or in the discount rate of +/-0.5 percentage points.

Of the total research and development costs incurred in 2013, €4,021 million (previous year: €2,615 million) met the criteria for capitalization under IFRSs.

The following amounts were recognized in profit or loss:

€ million	2013	2012
Research and noncapitalized development costs	7,722	6,900
Amortization of development costs	2,464	1,951
<b>Research and development costs recognized in the income statement</b>	<b>10,186</b>	<b>8,851</b>

### 13. Property, plant and equipment

**CHANGES IN PROPERTY, PLANT AND EQUIPMENT IN THE PERIOD JANUARY 1 TO DECEMBER 31, 2012**

€ million	Land, land rights and buildings, including buildings on third-party land*	Technical equipment and machinery	Other equipment, operating and office equipment	Payments on account and assets under construction	Total*
<b>Cost</b>					
<b>Balance at Jan. 1, 2012</b>	<b>22,000</b>	<b>31,531</b>	<b>41,537</b>	<b>4,616</b>	<b>99,684</b>
Foreign exchange differences	-48	-67	-242	-40	-397
Changes in consolidated Group	1,497	397	1,482	399	3,775
Additions	810	1,873	3,498	4,009	10,190
Transfers	559	753	1,894	-3,295	-89
Disposals	183	830	1,671	32	2,716
<b>Balance at Dec. 31, 2012</b>	<b>24,633</b>	<b>33,657</b>	<b>46,499</b>	<b>5,657</b>	<b>110,446</b>
<b>Depreciation and impairment</b>					
<b>Balance at Jan. 1, 2012</b>	<b>9,710</b>	<b>23,714</b>	<b>34,305</b>	<b>39</b>	<b>67,767</b>
Foreign exchange differences	-33	-42	-191	-2	-268
Changes in consolidated Group	18	5	11	-	34
Additions to cumulative depreciation	754	2,059	3,143	12	5,969
Additions to cumulative impairment losses	15	5	15	0	36
Transfers	-4	-560	570	-12	-6
Disposals	144	783	1,572	0	2,500
Reversal of impairment losses	-	3	0	6	9
<b>Balance at Dec. 31, 2012</b>	<b>10,315</b>	<b>24,395</b>	<b>36,282</b>	<b>30</b>	<b>71,022</b>
<b>Carrying amount at Dec. 31, 2012</b>	<b>14,318</b>	<b>9,262</b>	<b>10,217</b>	<b>5,627</b>	<b>39,424</b>
of which assets leased under finance leases carrying amount at Dec. 31, 2012	285	55	19	-	358

\* Figures adjusted because of the updated purchase price allocation for MAN.

Future finance lease payments due, and their present values, are shown in the following table:

€ million	2013	2014 – 2017	from 2018	Total
Finance lease payments	49	178	270	497
Interest component of finance lease payments	13	38	27	78
<b>Carrying amount/present value</b>	<b>36</b>	<b>140</b>	<b>243</b>	<b>419</b>

CONSOLIDATED FINANCIAL STATEMENTS  
Notes to the Consolidated Financial Statements

CHANGES IN PROPERTY, PLANT AND EQUIPMENT IN THE PERIOD JANUARY 1 TO DECEMBER 31, 2013

€ million	Land, land rights and buildings, including buildings on third-party land	Technical equipment and machinery	Other equipment, operating and office equipment	Payments on account and assets under construction	Total
<b>Cost</b>					
<b>Balance at Jan. 1, 2013</b>	<b>24,633</b>	<b>33,657</b>	<b>46,499</b>	<b>5,657</b>	<b>110,446</b>
Foreign exchange differences	-540	-908	-874	-185	-2,508
Changes in consolidated Group	137	15	30	75	258
Additions	897	2,016	3,506	4,642	11,061
Transfers	1,288	1,322	1,340	-3,954	-3
Disposals	139	942	1,203	77	2,362
<b>Balance at Dec. 31, 2013</b>	<b>26,277</b>	<b>35,159</b>	<b>49,297</b>	<b>6,158</b>	<b>116,891</b>
<b>Depreciation and impairment</b>					
<b>Balance at Jan. 1, 2013</b>	<b>10,315</b>	<b>24,395</b>	<b>36,282</b>	<b>30</b>	<b>71,022</b>
Foreign exchange differences	-188	-621	-654	-4	-1,468
Changes in consolidated Group	45	9	12	-	66
Additions to cumulative depreciation	824	2,226	3,637	1	6,689
Additions to cumulative impairment losses	11	2	97	8	118
Transfers	-13	-42	43	0	-12
Disposals	54	852	970	1	1,877
Reversal of impairment losses	1	25	0	9	35
<b>Balance at Dec. 31, 2013</b>	<b>10,939</b>	<b>25,091</b>	<b>38,447</b>	<b>26</b>	<b>74,503</b>
<b>Carrying amount at Dec. 31, 2013</b>	<b>15,338</b>	<b>10,068</b>	<b>10,850</b>	<b>6,132</b>	<b>42,389</b>
of which assets leased under finance leases carrying amount at Dec. 31, 2013	282	16	16	-	314

Options to purchase buildings and plant leased under the terms of finance leases exist in most cases, and are also expected to be exercised. Interest rates on the leases vary between 1.0% and 31.1% (previous year: between 1.6% and 11.0%), depending on the market and the date of inception of the lease.

Future finance lease payments due, and their present values, are shown in the following table:

€ million	2014	2015 – 2018	from 2019	Total
Finance lease payments	65	179	279	523
Interest component of finance lease payments	11	24	68	103
<b>Carrying amount/present value</b>	<b>54</b>	<b>155</b>	<b>211</b>	<b>420</b>

For assets leased under operating leases, payments recognized in the income statement amounted to €1,273 million (previous year: €1,164 million). With respect to internally used assets, €1,136 million (previous year: €1,024 million) of this figure is attributable to minimum lease payments and €51 million (previous year: €41 million) to contingent lease payments. The payments of €86 million (previous year: €99 million) under subleases primarily relate to minimum lease payments.

Government grants of €295 million (previous year: €418 million) were deducted from the cost of property, plant and equipment, and noncash benefits received amounting to €8 million (previous year: €4 million) were not capitalized as the cost of assets.

Real property liens of €661 million (previous year: €723 million) are pledged as collateral for financial liabilities related to land and buildings.

## 14. Leasing and rental assets and investment property

### CHANGES IN LEASING AND RENTAL ASSETS AND INVESTMENT PROPERTY IN THE PERIOD JANUARY 1 TO DECEMBER 31, 2012

€ million	Leasing and rental assets	Investment property	Total
<b>Cost</b>			
<b>Balance at Jan. 1, 2012</b>	<b>21,359</b>	<b>525</b>	<b>21,884</b>
Foreign exchange differences	-215	-5	-220
Changes in consolidated Group	1,470	2	1,472
Additions	9,816	34	9,851
Transfers	-1	89	89
Disposals	6,976	19	6,996
<b>Balance at Dec. 31, 2012</b>	<b>25,453</b>	<b>626</b>	<b>26,079</b>
<b>Depreciation and impairment</b>			
<b>Balance at Jan. 1, 2012</b>	<b>4,733</b>	<b>185</b>	<b>4,918</b>
Foreign exchange differences	-69	-1	-70
Changes in consolidated Group	8	2	10
Additions to cumulative depreciation	3,498	14	3,512
Additions to cumulative impairment losses	99	0	99
Transfers	-3	6	3
Disposals	2,845	12	2,857
Reversal of impairment losses	2	1	3
<b>Balance at Dec. 31, 2012</b>	<b>5,419</b>	<b>194</b>	<b>5,612</b>
<b>Carrying amount at Dec. 31, 2012</b>	<b>20,034</b>	<b>433</b>	<b>20,467</b>

The following payments from noncancelable leases and rental agreements were expected to be received over the coming years:

€ million	2013	2014 – 2017	after 2018	Total
Lease payments	2,688	2,995	39	5,723

CONSOLIDATED FINANCIAL STATEMENTS  
Notes to the Consolidated Financial Statements

CHANGES IN LEASING AND RENTAL ASSETS AND INVESTMENT PROPERTY IN THE PERIOD  
JANUARY 1 TO DECEMBER 31, 2013

€ million	Leasing and rental assets	Investment property	Total
<b>Cost</b>			
<b>Balance at Jan. 1, 2013</b>	<b>25,453</b>	<b>626</b>	<b>26,079</b>
Foreign exchange differences	-908	-12	-920
Changes in consolidated Group	3	-	3
Additions	11,890	32	11,923
Transfers	-1	32	31
Disposals	6,558	46	6,604
<b>Balance at Dec. 31, 2013</b>	<b>29,878</b>	<b>633</b>	<b>30,511</b>
<b>Depreciation and impairment</b>			
<b>Balance at Jan. 1, 2013</b>	<b>5,419</b>	<b>194</b>	<b>5,612</b>
Foreign exchange differences	-212	-2	-215
Changes in consolidated Group	0	-	0
Additions to cumulative depreciation	4,087	14	4,101
Additions to cumulative impairment losses	107	1	108
Transfers	0	12	12
Disposals	1,766	13	1,779
Reversal of impairment losses	16	-	16
<b>Balance at Dec. 31, 2013</b>	<b>7,619</b>	<b>205</b>	<b>7,824</b>
<b>Carrying amount at Dec. 31, 2013</b>	<b>22,259</b>	<b>427</b>	<b>22,687</b>

Leasing and rental assets include assets leased out under the terms of operating leases and assets covered by long-term buy-back agreements.

Investment property includes apartments rented out and leased dealerships with a fair value of €732 million (previous year: €758 million). Fair value is estimated using an investment method based on internal calculations (Level 3 of the fair value hierarchy). Operating expenses of €47 million (previous year: €50 million) were incurred for the maintenance of investment property in use. Expenses of €0 million (previous year: €1 million) were incurred for unused investment property.

The following payments from noncancelable leases and rental agreements are expected to be received over the coming years:

€ million	2014	2015 – 2018	after 2019	Total
Lease payments	2,635	2,971	23	5,628

## 15. Equity-accounted investments and other equity investments

### CHANGES IN EQUITY-ACCOUNTED INVESTMENTS AND OTHER EQUITY INVESTMENTS IN THE PERIOD JANUARY 1 TO DECEMBER 31, 2012

€ million	Equity- accounted investments	Other equity investments	Total
<b>Gross carrying amount at Jan. 1, 2012</b>	<b>10,261</b>	<b>3,264</b>	<b>13,526</b>
Foreign exchange differences	-25	-3	-28
Changes in consolidated Group	-12,742	-46	-12,788
Additions	10,812	488	11,301
Transfers	0	0	-
Disposals	2	16	17
Changes recognized in profit or loss	3,226	-	3,226
Dividends	-3,925	-	-3,925
Other changes recognized in other comprehensive income	-243	419	176
<b>Balance at Dec. 31, 2012</b>	<b>7,362</b>	<b>4,107</b>	<b>11,469</b>
<b>Impairment losses</b>			
<b>Balance at Jan. 1, 2012</b>	<b>12</b>	<b>216</b>	<b>228</b>
Foreign exchange differences	0	-1	-1
Changes in consolidated Group	-	1	1
Additions	41	20	62
Transfers	-	-	-
Disposals	-	0	0
Reversal of impairment losses	-	-	-
<b>Balance at Dec. 31, 2012</b>	<b>53</b>	<b>236</b>	<b>290</b>
<b>Carrying amount at Dec. 31, 2012</b>	<b>7,309</b>	<b>3,870</b>	<b>11,179</b>

**CHANGES IN EQUITY-ACCOUNTED INVESTMENTS AND OTHER EQUITY INVESTMENTS IN THE PERIOD  
JANUARY 1 TO DECEMBER 31, 2013**

€ million	Equity- accounted investments	Other equity investments	Total
<b>Gross carrying amount at Jan. 1, 2013</b>	<b>7,362</b>	<b>4,107</b>	<b>11,469</b>
Foreign exchange differences	-24	-6	-30
Changes in consolidated Group	-3	-259	-262
Additions	38	297	335
Transfers	27	-27	0
Disposals	3	23	25
Changes recognized in profit or loss	3,612	-	3,612
Dividends	-2,827	-	-2,827
Other changes recognized in other comprehensive income	-170	88	-82
<b>Balance at Dec. 31, 2013</b>	<b>8,014</b>	<b>4,177</b>	<b>12,191</b>
<b>Impairment losses</b>			
<b>Balance at Jan. 1, 2013</b>	<b>53</b>	<b>236</b>	<b>290</b>
Foreign exchange differences	0	-1	-2
Changes in consolidated Group	-	-31	-31
Additions	26	37	63
Transfers	-	-	-
Disposals	-	3	3
Reversal of impairment losses	-	0	0
<b>Balance at Dec. 31, 2013</b>	<b>80</b>	<b>237</b>	<b>316</b>
<b>Carrying amount at Dec. 31, 2013</b>	<b>7,934</b>	<b>3,941</b>	<b>11,875</b>

Equity-accounted investments include joint ventures in the amount of €7,563 million (previous year: €6,870 million) and associates in the amount of €370 million (previous year: €439 million).

In fiscal year 2012, €12,566 million of the changes in the consolidated Group concerning equity-accounted investments related to the reclassification of the shares of Porsche Holding Stuttgart because of the initial consolidation of that company. The income of €10,716 million from the remeasurement of the existing shares held resulting from discontinuation of equity-method accounting was reported under additions.

Of the other changes recognized in other comprehensive income, €-162 million (previous year: €-245 million) is attributable to joint ventures and €-7 million (previous year: €2 million) to associates. They are mainly the result of foreign exchange differences in the amount of €-136 million (previous year: €-48 million), pension plan remeasurements in the amount of €-9 million (previous year: €-135 million) and losses on the fair value measurement of cash flow hedges in the amount of €-36 million (previous year: €-185 million).

## 16. Noncurrent and current financial services receivables

€ million	CARRYING AMOUNT			FAIR VALUE	CARRYING AMOUNT			FAIR VALUE
	Current	Noncurrent	Dec. 31, 2013	Dec. 31, 2013	Current	Noncurrent	Dec. 31, 2012	Dec. 31, 2012
Receivables from financing business								
Customer financing	17,998	35,965	53,963	55,562	17,277	34,460	51,737	52,439
Dealer financing	11,658	1,368	13,026	12,987	11,389	1,330	12,719	12,647
Direct banking	183	1	184	184	167	1	168	168
	<b>29,839</b>	<b>37,334</b>	<b>67,173</b>	<b>68,733</b>	<b>28,832</b>	<b>35,791</b>	<b>64,624</b>	<b>65,254</b>
Receivables from operating leases	214	–	214	214	204	–	204	204
Receivables from finance leases	8,332	13,864	22,196	22,639	7,875	13,994	21,868	21,944
	<b>38,386</b>	<b>51,198</b>	<b>89,583</b>	<b>91,586</b>	<b>36,911</b>	<b>49,785</b>	<b>86,696</b>	<b>87,402</b>

Noncurrent receivables from the customer financing business mainly bear fixed rates of interest of between 0.0% and 39.1% (previous year: 0.0% and 37.0%), depending on the market concerned. They have terms of up to 240 months (previous year: 242 months). The noncurrent portion of dealer financing is granted at interest rates of between 0.0% and 25.9% (previous year: 0.0% and 18.4%), depending on the country.

The receivables from customer financing and finance leases contained in financial services receivables of €89.6 billion (previous year: €86.7 billion) decreased by €34 million as a result of a fair value adjustment from portfolio hedging (previous year: increase of €56 million).

The receivables from customer and dealer financing are secured by vehicles or real property liens. Collateral of €351 million (previous year: €357 million) has been furnished for financial liabilities and contingent liabilities.

The receivables from dealer financing include €71 million (previous year: €124 million) receivable from affiliated companies.



**CONSOLIDATED FINANCIAL STATEMENTS**  
Notes to the Consolidated Financial Statements

The receivables from finance leases – almost entirely in respect of vehicles – were or are expected to generate the following cash flows as of December 31, 2012 and December 31, 2013:

€ million	2013	2014 – 2017	after 2018	Total
Future payments from finance lease receivables	8,557	14,827	176	23,561
Unearned finance income from finance leases (discounting)	– 683	– 1,005	– 5	– 1,692
<b>Present value of minimum lease payments outstanding at the reporting date</b>	<b>7,875</b>	<b>13,822</b>	<b>171</b>	<b>21,868</b>

€ million	2014	2015 – 2018	after 2019	Total
Future payments from finance lease receivables	8,939	14,623	122	23,684
Unearned finance income from finance leases (discounting)	– 607	– 879	– 2	– 1,488
<b>Present value of minimum lease payments outstanding at the reporting date</b>	<b>8,332</b>	<b>13,744</b>	<b>120</b>	<b>22,196</b>

Accumulated valuation allowances for uncollectible minimum lease payments receivable amount to €–112 million (previous year: €–158 million).

## 17. Noncurrent and current other financial assets

€ million	CARRYING AMOUNT			CARRYING AMOUNT		
	Current	Noncurrent	Dec. 31, 2013	Current	Noncurrent	Dec. 31, 2012
Positive fair value of derivatives	1,680	2,414	4,094	832	2,226	3,057
Marketable securities	–	1,565	1,565	–	1,612	1,612
Receivables from loans, bonds, profit participation rights (excluding interest)	2,729	2,472	5,201	2,777	2,024	4,801
Miscellaneous financial assets	2,182	590	2,772	2,263	570	2,833
	<b>6,591</b>	<b>7,040</b>	<b>13,631</b>	<b>5,872</b>	<b>6,431</b>	<b>12,304</b>

Other financial assets include receivables from related parties of €5,170 million (previous year: €5,033 million). Other financial assets and current marketable securities of €3,119 million (previous year: €3,267 million) were furnished as collateral for financial liabilities and contingent liabilities. There is no original right of disposal or pledge for the furnished collateral on the part of the collateral taker.

There are restrictions on the disposal of the certificates of deposit amounting to €1.5 billion reported in noncurrent securities (see the disclosures on “Interests in joint ventures”). In addition, the miscellaneous other financial assets include cash and cash equivalents that serve as collateral (mainly under asset-backed securities transactions).

The positive fair values of derivatives relate to the following items:

€ million	Dec. 31, 2013	Dec. 31, 2012
<b>Transactions for hedging</b>		
foreign currency risk from assets using fair value hedges	97	11
foreign currency risk from liabilities using fair value hedges	55	16
interest rate risk using fair value hedges	340	671
interest rate risk using cash flow hedges	5	1
foreign currency and price risk from future cash flows (cash flow hedges)	3,225	1,802
<b>Hedging transactions</b>	<b>3,721</b>	<b>2,501</b>
Assets related to derivatives not included in hedging relationships	373	556
	<b>4,094</b>	<b>3,057</b>

The positive fair value of transactions for hedging price risk from future cash flows (cash flow hedges) amounted to €21 million (previous year: €76 million).

Positive fair values of €20 million (previous year: €41 million) were recognized from transactions for hedging interest rate risk (fair value hedges) used in portfolio hedges.

Further details on derivative financial instruments as a whole are given in note 33.

## 18. Noncurrent and current other receivables

€ million	CARRYING AMOUNT			CARRYING AMOUNT		
	Current	Noncurrent	Dec. 31, 2013	Current	Noncurrent	Dec. 31, 2012
Recoverable income taxes	3,111	96	3,207	3,092	76	3,168
Miscellaneous receivables	1,919	1,360	3,279	1,731	1,595	3,326
	<b>5,030</b>	<b>1,456</b>	<b>6,486</b>	<b>4,823</b>	<b>1,671</b>	<b>6,494</b>

Miscellaneous receivables include assets to fund post-employment benefits in the amount of €65 million (previous year: €36 million). This item also includes the share of the technical provisions attributable to reinsurers amounting to €98 million (previous year: €131 million).

There are no material restrictions on title or right of use in respect of the reported other receivables. Default risks are accounted for by means of valuation allowances.

Current other receivables are predominantly non-interest-bearing.

## 19. Tax assets

€ million	CARRYING AMOUNT			CARRYING AMOUNT		
	Current	Noncurrent	Dec. 31, 2013	Current	Noncurrent*	Dec. 31, 2012*
Deferred tax assets	–	5,622	5,622	–	7,836	7,836
Tax receivables	729	633	1,362	761	552	1,313
	<b>729</b>	<b>6,255</b>	<b>6,984</b>	<b>761</b>	<b>8,387</b>	<b>9,148</b>

\* Prior-year figures adjusted to reflect application of IAS 19R.

€4,393 million (previous year: €4,060 million) of the deferred tax assets is due within one year.

## 20. Inventories

€ million	Dec. 31, 2013	Dec. 31, 2012
Raw materials, consumables and supplies	3,716	3,506
Work in progress	3,096	3,504
Finished goods and purchased merchandise	18,284	18,015
Current leasing and rental assets	3,418	3,477
Payments on account	140	172
	<b>28,653</b>	<b>28,674</b>

Of the total inventories, €4,211 million (previous year: €3,576 million) is recognized at net realizable value. At the same time as the relevant revenue was recognized, inventories in the amount of €152,290 million were included in cost of sales (previous year: €150,121 million). Valuation allowances recognized as expenses in the reporting period amounted to €911 million (previous year: €748 million). Vehicles amounting to €220 million (previous year: €260 million) were assigned as collateral for partial retirement obligations.

## 21. Trade receivables

€ million	Dec. 31, 2013	Dec. 31, 2012
Trade receivables from		
third parties	9,126	8,705
affiliated companies	266	167
joint ventures	1,712	1,191
associates	26	33
other investees and investors	3	3
	<b>11,133</b>	<b>10,099</b>

The fair values of the trade receivables correspond to the carrying amounts.

The trade receivables include receivables from construction contracts accounted for using the percentage of completion (PoC) method. These are calculated as follows:

€ million	Dec. 31, 2013	Dec. 31, 2012
Contract costs and proportionate contract profit/loss of construction contracts	1,575	1,704
of which billed to customers	-49	-11
Exchange rate effects	-3	-2
PoC receivables, gross	1,523	1,691
Prepayments received	-1,272	-1,475
<b>PoC receivables, net</b>	<b>251</b>	<b>217</b>

Other payments received on account of construction contracts in the amount of €350 million (previous year: €407 million), for which no construction costs have yet been incurred, are recognized under other liabilities.

## 22. Marketable securities

The marketable securities serve to safeguard liquidity. Marketable securities are quoted, mainly short-term fixed-income securities and shares allocated to the available-for-sale financial instruments category.

## 23. Cash, cash equivalents and time deposits

€ million	Dec. 31, 2013	Dec. 31, 2012
Bank balances	22,997	18,017
Checks, cash-in-hand, bills and call deposits	181	471
	<b>23,178</b>	<b>18,488</b>

Bank balances are held at various banks in different currencies and include time deposits, for example.

## 24. Equity

The subscribed capital of Volkswagen AG is composed of no-par value bearer shares with a notional value of €2.56. As well as ordinary shares, there are preferred shares that entitle the bearer to a €0.06 higher dividend than ordinary shares, but do not carry voting rights.

The subscribed capital is composed of 295,089,818 no-par value ordinary shares and 170,148,171 preferred shares. In the first quarter of 2013, Volkswagen AG issued 5,393 newly created preferred shares (notional value: €13,806) resulting from the exercise of mandatory convertible notes.

Authorized capital of up to €110 million, expiring on April 18, 2017, was approved for the issue of new ordinary bearer shares or preferred shares based on the resolution by the Annual General Meeting on April 19, 2012.

Following the capital increase implemented in fiscal year 2010, there is still authorized capital of up to €179.4 million, resolved by the Extraordinary General Meeting on December 3, 2009 and expiring on December 2, 2014, to issue up to 70,095,502 new no-par value preferred bearer shares.

The Annual General Meeting on April 22, 2010 resolved to create contingent capital in the amount of up to €102.4 million expiring on April 21, 2015 that can be used to issue up to €5 billion in bonds with warrants and/or convertible bonds.

To date, Volkswagen has used this contingent capital as follows:

- > In November 2012, via a subsidiary, Volkswagen International Finance N.V. Amsterdam/the Netherlands (issuer), Volkswagen AG placed a €2.5 billion mandatory convertible note that entitles and obliges holders to subscribe for Volkswagen preferred shares. The preemptive rights of existing shareholders were disapplied. The convertible note bears a coupon of 5.50% and matures on November 9, 2015.
- > In June 2013, Volkswagen placed another €1.2 billion mandatory convertible note to supplement the mandatory convertible note issued in November 2012. The features of the new mandatory convertible note correspond to those of the mandatory convertible note issued in November 2012. It was issued at a price of 105.64% of the principal amount. Additionally, accrued interest (€1 million) was received and deferred. The new mandatory convertible note also matures on November 9, 2015. Because of the fixed conversion ratio, the mandatory convertible note is recognized in the capital reserves at an amount of €1,149 million, including a premium and deferred interest (€69 million), net of transaction costs (€14 million) and the deferral of taxes (€49 million), and in the financial liabilities at an amount of €156 million.

The current minimum conversion price for the mandatory convertible notes is €150.81, and the maximum conversion price is €180.97. The conversion price will be adjusted if certain events occur. The convertible notes will be settled by issuing new preferred shares no later than at maturity. The issuer is entitled to convert the mandatory convertible notes at any time at the minimum conversion price. The note terms and conditions also provide for early conversion options. This discretionary conversion right was exercised in the reporting period, with a total of €1 million of the notes being converted into 5,393 newly created preferred shares at the effective maximum conversion price at the conversion date.

Following the approval by the Annual General Meeting of MAN SE of the conclusion of a control and profit and loss transfer agreement on June 6, 2013, the noncontrolling interests in the equity of MAN SE were derecognized from Group equity as a capital transaction involving a change in ownership interest. At the same time, a liability was recognized as a separate item of current liabilities in accordance with the cash settlement offer. This reduces the Volkswagen Group's equity by a total of €3,125 million. For more information, please see the disclosures on the basis of consolidation.

In August 2013, Volkswagen AG placed unsecured subordinated hybrid notes with an aggregate principal amount of €2 billion via a subsidiary, Volkswagen International Finance N.V. Amsterdam/the Netherlands (issuer). The issuer transferred the proceeds to Volkswagen AG under the terms of a loan agreement. The perpetual hybrid notes were issued in two tranches and can be called by the issuer. The first call date for the first tranche (€1.25 billion and a coupon of 3.875%) is after five years, and the first call date for the second tranche (€0.75 billion and a coupon of 5.125%) is after ten years. Under IAS 32, the hybrid notes must be classified in their entirety as equity. The capital raised was recognized in equity, less a discount and transaction costs and net of deferred taxes. The interest payments payable to the noteholders will be recognized directly in equity, net of income taxes.

**CHANGE IN ORDINARY AND PREFERRED SHARES AND SUBSCRIBED CAPITAL**

	SHARES		€	
	2013	2012	2013	2012
<b>Balance at January 1</b>	<b>465,232,596</b>	<b>465,232,595</b>	<b>1,190,995,446</b>	<b>1,190,995,443</b>
Capital increase		1		3
Conversion of mandatory convertible notes	5,393	–	13,806	–
<b>Balance at December 31</b>	<b>465,237,989</b>	<b>465,232,596</b>	<b>1,191,009,252</b>	<b>1,190,995,446</b>

The capital reserves comprise the share premium totaling €12,332 million (previous year: €11,183 million) from capital increases, the share premium of €219 million from the issuance of bonds with warrants and an amount of €107 million appropriated on the basis of the capital reduction implemented in 2006. The capital reserves increased by €1,149 million in the reporting period (previous year: €2,181 million) due to the issuance of the mandatory convertible note. As a portion of the mandatory convertible note that had been issued was converted in fiscal year 2013, an amount of €13,806 was reclassified from the capital reserves to subscribed capital (see also note 11). No amounts were withdrawn from the capital reserves.

**DIVIDEND PROPOSAL**

In accordance with section 58(2) of the Aktiengesetz (AktG – German Stock Corporation Act), the dividend payment by Volkswagen AG is based on the net retained profits reported in the annual financial statements of Volkswagen AG prepared in accordance with the German Commercial Code. Based on these annual financial statements of Volkswagen AG, net retained profits of €1,874 million are eligible for distribution following the appropriation of €1,210 million to the revenue reserves. The Board of Management and Supervisory Board will propose to the Annual General Meeting that a total dividend of €1,871 million, i.e. €4.00 per ordinary share and €4.06 per preferred share, be paid from the net retained profits. Shareholders are not entitled to a dividend payment until it has been resolved by the Annual General Meeting.

A dividend of €3.50 per ordinary share and €3.56 per preferred share was distributed in fiscal year 2013.

**NONCONTROLLING INTERESTS**

The noncontrolling interests in equity are attributable primarily to shareholders of Scania AB. Please see the disclosures on the basis of consolidation for explanatory notes regarding the derecognition of noncontrolling interests in the equity of MAN SE.

## 25. Noncurrent and current financial liabilities

The details of noncurrent and current financial liabilities are presented in the following table:

€ million	CARRYING AMOUNT			CARRYING AMOUNT		
	Current	Noncurrent	Dec. 31, 2013	Current	Noncurrent	Dec. 31, 2012
Bonds	16,645	39,677	56,322	12,822	36,883	49,705
Commercial paper and notes	9,281	11,953	21,233	9,206	12,687	21,892
Liabilities to banks	11,305	7,659	18,964	9,670	10,621	20,291
Deposit business	22,310	1,015	23,325	21,974	1,943	23,917
Loans and miscellaneous liabilities	396	850	1,247	355	1,074	1,428
Bills of exchange	–	–	–	0	–	0
Finance lease liabilities	50	363	413	33	396	429
	<b>59,987</b>	<b>61,517</b>	<b>121,504</b>	<b>54,060</b>	<b>63,603</b>	<b>117,663</b>

The deposits from direct banking business contained in the financial liabilities of €121.5 billion (previous year: €117.7 billion) decreased by €5.5 million as a result of a fair value adjustment from portfolio hedging (previous year: increase of €3.4 million).

Asset-backed securities transactions amounting to €19,076 million (previous year: €17,655 million) entered into to refinance the financial services business are included in bonds, commercial paper and notes, and liabilities from loans. Receivables of €24,529 million (previous year: €21,543 million) from the customer finance and leasing business are pledged as collateral. The expected payments are assigned to special purpose entities and the financed vehicles transferred as collateral.

Most of the public and private asset-backed securities transactions of the Volkswagen Financial Services AG group can be repaid in advance (clean-up call) if less than 9% or 10%, as appropriate, of the original transaction volume is outstanding. The asset-backed securities transactions of Volkswagen Financial Services (UK) will have been largely repaid by the time all of the liabilities have been redeemed.

## 26. Noncurrent and current other financial liabilities

€ million	CARRYING AMOUNT			CARRYING AMOUNT		
	Current	Noncurrent	Dec. 31, 2013	Current	Noncurrent	Dec. 31, 2012
Negative fair values of derivative financial instruments	1,070	1,169	2,239	1,230	1,587	2,818
Interest payable	667	62	730	731	6	737
Miscellaneous financial liabilities	2,789	1,074	3,863	2,464	803	3,267
	<b>4,526</b>	<b>2,305</b>	<b>6,832</b>	<b>4,425</b>	<b>2,397</b>	<b>6,822</b>

The negative fair values of derivatives relate to the following items:

€ million	Dec. 31, 2013	Dec. 31, 2012
Transactions for hedging		
foreign currency risk from assets using fair value hedges	34	21
foreign currency risk from liabilities using fair value hedges	300	53
interest rate risk using fair value hedges	117	238
interest rate risk using cash flow hedges	30	77
foreign currency and price risk from future cash flows (cash flow hedges)	996	1,822
<b>Hedging transactions</b>	<b>1,476</b>	<b>2,211</b>
Liabilities related to derivatives not included in hedging relationships	762	607
	<b>2,239</b>	<b>2,818</b>

The negative fair value of transactions for hedging price risk from future cash flows (cash flow hedges) amounted to €61 million (previous year: €26 million).

Negative fair values of €41 million (previous year: €158 million) were recognized from transactions for hedging interest rate risk (fair value hedges) used in portfolio hedges.

Further details on derivative financial instruments as a whole are given in note 33.

## 27. Noncurrent and current other liabilities

€ million	CARRYING AMOUNT			CARRYING AMOUNT		
	Current	Noncurrent	Dec. 31, 2013	Current	Noncurrent	Dec. 31, 2012
Payments on account received in respect of orders	3,785	702	4,487	3,891	779	4,671
Liabilities relating to						
other taxes	1,850	465	2,316	1,652	388	2,040
social security	444	22	466	458	32	490
wages and salaries	2,735	559	3,294	2,730	715	3,446
Miscellaneous liabilities	2,190	2,778	4,968	2,380	2,761	5,140
	<b>11,004</b>	<b>4,527</b>	<b>15,530</b>	<b>11,111</b>	<b>4,675</b>	<b>15,786</b>



## 28. Tax liabilities

€ million	CARRYING AMOUNT			CARRYING AMOUNT		
	Current	Noncurrent	Dec. 31, 2013	Current	Noncurrent	Dec. 31, 2012
Deferred tax liabilities	–	7,894	7,894	–	9,050	9,050
Provisions for taxes	2,869	3,674	6,543	1,721	4,239	5,960
Current tax payables	218	–	218	238	–	238
	<b>3,086</b>	<b>11,567</b>	<b>14,654</b>	<b>1,959</b>	<b>13,289</b>	<b>15,248</b>

€40 million (previous year: €14 million) of the deferred tax liabilities is due within one year.

## 29. Provisions for pensions and other post-employment benefits

Provisions for pensions are recognized for commitments in the form of retirement, invalidity and dependents' benefits payable under pension plans. The benefits provided by the Group vary according to the legal, tax and economic circumstances of the country concerned, and usually depend on the length of service and remuneration of the employees.

Volkswagen Group companies provide occupational pensions under both defined contribution and defined benefit plans. In the case of defined contribution plans, the Company makes contributions to state or private pension schemes based on legal or contractual requirements, or on a voluntary basis. Once the contributions have been paid, there are no further obligations for the Volkswagen Group. Current contributions are recognized as pension expenses of the period concerned. In 2013, they amounted to a total of €1,670 million (previous year: €1,580 million) in the Volkswagen Group. Of this figure, contributions to the compulsory state pension system in Germany amounted to €1,292 million (previous year: €1,219 million).

Most pension plans are defined benefit plans, with a distinction made between pensions financed by provisions and externally funded plans.

The pension provisions for defined benefits are measured by independent actuaries using the internationally accepted projected unit credit method in accordance with IAS 19, under which the future obligations are measured on the basis of the ratable benefit entitlements earned as of the balance sheet date. Measurement reflects actuarial assumptions as to discount rates, salary and pension trends, employee turnover rates, longevity and increases in healthcare costs, which were determined for each Group company depending on the economic environment. Actuarial gains or losses arise from differences between what has actually occurred and the prior-year assumptions as well as from changes in assumptions. They are recognized in other comprehensive income, net of deferred taxes, in the period in which they arise.

Multi-employer pension plans exist in the Volkswagen Group in the United Kingdom, Switzerland, Sweden, the Netherlands and Japan. These plans are defined benefit plans. A small proportion of them are accounted for as defined contribution plans, as the Volkswagen Group is not authorized to receive the information required in order to account for them as defined benefit plans. Under the terms of the multi-employer plans, the Volkswagen Group is not liable for the obligations of the other employers. In the event of its withdrawal from the plans or their winding-up, the proportionate share of the surplus of assets attributable to the Volkswagen Group will be credited or the proportionate share of the deficit attributable to the Volkswagen Group will have to be funded. In the case of the defined benefit plans accounted for as defined contribution plans, the Volkswagen Group's share of the obligations represents a small proportion of the total obligations. It is not aware of any probable significant risks arising from multi-employer defined benefit pension plans that are accounted for as defined contribution plans. The expected contributions to those plans will amount to €17 million for fiscal year 2014.

Owing to their benefit character, the obligations of the US Group companies in respect of post-employment medical care in particular are also carried under provisions for pensions and other post-employment benefits. These post-employment benefit provisions take into account the expected long-term rise in the cost of healthcare. €16 million (previous year: €18 million) was recognized in fiscal year 2013 as an expense for health care costs. The related carrying amount as of December 31, 2013 was €177 million (previous year: €226 million).

The following amounts were recognized in the balance sheet for defined benefit plans:

€ million	Dec. 31, 2013	Dec. 31, 2012*
Present value of funded obligations	8,728	8,824
Fair value of plan assets	7,970	7,288
Funded status (net)	758	1,536
Present value of unfunded obligations	20,929	22,361
Amount not recognized as an asset because of the ceiling in IAS 19	22	7
<b>Net liability recognized in the balance sheet</b>	<b>21,709</b>	<b>23,903</b>
of which provisions for pensions	21,774	23,939
of which other assets	65	36

\* Prior-year figures adjusted to reflect application of IAS 19R.

#### SIGNIFICANT PENSION ARRANGEMENTS IN THE VOLKSWAGEN GROUP

For the period after their active working life, the Volkswagen Group offers its employees benefits under attractive, modern occupational pension arrangements. Most of the arrangements in the Volkswagen Group are pension plans for employees in Germany classified as defined benefit plans under IAS 19. The majority of these obligations are funded solely by recognized provisions. These plans are now largely closed to new members. To reduce the risks associated with defined benefit plans, in particular longevity, salary increases and inflation, the Volkswagen Group has introduced new defined benefit plans in recent years whose benefits are funded by appropriate external plan assets. The above-mentioned risks have been largely reduced in these pension plans. The proportion of the total defined benefit obligation attributable to pension obligations funded by plan assets will continue to rise in the future. The significant pension plans are described in the following.

#### GERMAN PENSION PLANS FUNDED SOLELY BY RECOGNIZED PROVISIONS

The pension plans funded solely by recognized provisions comprise both contribution-based plans with guarantees and final salary plans. For contribution-based plans, an annual pension expense dependent on income and status is converted into a lifelong pension entitlement using annuity factors (guaranteed modular pension entitlements). The annuity factors include a guaranteed rate of interest. At retirement, the modular pension entitlements earned annually are added together. For final salary plans, the underlying salary is multiplied at retirement by a percentage that depends on the years of service up until the retirement date.

The present value of the guaranteed obligation rises as interest rates fall and is therefore exposed to interest rate risk.

The pension system provides for lifelong pension payments. The companies bear the longevity risk in this respect. This is accounted for by calculating the annuity factors and the present value of the guaranteed obligation using the latest generational mortality tables – the “Heubeck 2005 G” mortality tables – which already reflect future increases in life expectancy.

To reduce the inflation risk from adjusting the regular pension payments by the rate of inflation, a pension adjustment that is not indexed to inflation was introduced for pension plans where this is permitted by law.

**GERMAN PENSION PLANS FUNDED BY EXTERNAL PLAN ASSETS**

The pension plans funded by external plan assets are contribution-based plans with guarantees. In this case, an annual pension expense dependent on income and status is either converted into a lifelong pension entitlement using annuity factors (guaranteed modular pension entitlement) or paid out in a single lump sum or in installments. In some cases, employees also have the opportunity to provide for their own retirement through deferred compensation. The annuity factors include a guaranteed rate of interest. At retirement, the modular pension entitlements earned annually are added together. The pension expense is contributed on an ongoing basis to a separate pool of assets that is administered in trust. These assets are invested in the capital markets by trusts that are independent of the Company. If the plan assets exceed the present value of the obligations calculated using the guaranteed rate of interest, surpluses are allocated (modular pension bonuses).

Since the assets administered in trust meet the IAS 19 criteria for classification as plan assets, they are deducted from the obligations.

The amount of the pension assets is exposed to general market risk. The investment strategy and its implementation are therefore continuously monitored by the trusts' governing bodies, on which the companies are also represented. For example, investment policies are stipulated in investment guidelines with the aim of limiting market risk and its impact on plan assets. In addition, asset-liability management studies are conducted if required so as to ensure that investments are in line with the obligations that need to be covered. The pension assets are currently invested primarily in fixed-income or equity funds. The main risks are therefore interest rate and equity price risk. To mitigate market risk, the pension system also provides for cash funds to be set aside in an equalization reserve before any surplus is allocated.

The present value of the obligation is the present value of the guaranteed obligation after deducting the plan assets. If the plan assets fall below the present value of the guaranteed obligation, a provision must be recognized in that amount. The present value of the guaranteed obligation rises as interest rates fall and is therefore exposed to interest rate risk.

In the case of lifelong pension payments, the Volkswagen Group bears the longevity risk. This is accounted for by calculating the annuity factors and the present value of the guaranteed obligation using the latest generational mortality tables – the “Heubeck 2005 G” mortality tables – which already reflect future increases in life expectancy. In addition, the independent actuaries carry out annual risk monitoring as part of the review of the assets administered by the trusts.

To reduce the inflation risk from adjusting the regular pension payments by the rate of inflation, a pension adjustment that is not indexed to inflation was introduced for pension plans where this is permitted by law.

Calculation of the pension provisions was based on the following actuarial assumptions:

	GERMANY		ABROAD	
	2013	2012	2013	2012
%				
Discount rate at December 31	3.70	3.20	5.51	4.66
Payroll trend	3.36	2.78	3.24	3.87
Pension trend	1.80	1.80	3.02	2.29
Employee turnover rate	1.03	1.02	3.76	4.22
Annual increase in healthcare costs	–	–	5.51	6.08

These assumptions are averages that were weighted using the present value of the defined benefit obligation.

With regard to life expectancy, consideration is given to the latest mortality tables in each country.

The discount rates are generally defined to reflect the yields on prime-rated corporate bonds with matching maturities and currencies. The iBoxx AA 10+ Corporates index was taken as the basis for the obligations of German Group companies. Similar indices were used for foreign pension obligations.

The payroll trends cover expected wage and salary trends, which also include increases attributable to career development.

The pension trends either reflect the contractually guaranteed pension adjustments or are based on the rules on pension adjustments in force in each country.

The employee turnover rates are based on past experience and future expectations.

The following table shows changes in the net defined benefit liability recognized in the balance sheet:

€ million	2013	2012*
<b>Net liability recognized in the balance sheet at January 1</b>	<b>23,903</b>	<b>16,705</b>
Current service cost	759	573
Net interest expense	752	760
Actuarial gains (-)/losses (+) arising from changes in demographic assumptions	21	-14
Actuarial gains (-)/losses (+) arising from changes in financial assumptions	-2,323	5,518
Actuarial gains (-)/losses (+) arising from experience adjustments	-16	193
Income/expenses from plan assets not included in interest income	49	108
Change in amount not recognized as an asset because of the ceiling in IAS 19	-17	6
Employer contributions to plan assets	572	440
Pension payments from company assets	766	762
Past service cost (including plan curtailments)	4	-10
Gains (-) or losses (+) arising from plan settlements	1	0
Changes in consolidated Group	1	1,424
Other changes	47	78
Foreign exchange differences from foreign plans	-72	-8
<b>Net liability recognized in the balance sheet at December 31</b>	<b>21,709</b>	<b>23,903</b>

\* Prior-year figures adjusted to reflect application of IAS 19R.

**CONSOLIDATED FINANCIAL STATEMENTS**  
Notes to the Consolidated Financial Statements

The change in the present value of the defined benefit obligation is attributable to the following factors:

€ million	2013	2012*
<b>Present value of obligations at January 1</b>	<b>31,185</b>	<b>23,251</b>
Current service cost	759	573
Interest cost	1,041	1,102
Actuarial gains(-)/losses (+) arising from changes in demographic assumptions	21	-14
Actuarial gains(-)/losses (+) arising from changes in financial assumptions	-2,323	5,518
Actuarial gains(-)/losses (+) arising from experience adjustments	-16	193
Employee contributions to plan assets	41	41
Pension payments from company assets	766	762
Pension payments from plan assets	222	210
Past service cost (including plan curtailments)	4	-10
Gains (-) or losses (+) arising from plan settlements	1	0
Changes in consolidated Group	1	1,485
Other changes	197	84
Foreign exchange differences from foreign plans	-266	-67
<b>Present value of obligations at December 31</b>	<b>29,657</b>	<b>31,185</b>

\* Prior-year figures adjusted to reflect application of IAS 19R.

Changes in the relevant actuarial assumptions would have had the following effects on the defined benefit obligation:

Present value of defined benefit obligation if		DEC. 31, 2013	
		€ million	Change in percent
Discount rate	is 0.5 percentage points higher	27,656	-6.75
	is 0.5 percentage points lower	32,263	8.79
Pension trend	is 0.5 percentage points higher	31,113	4.91
	is 0.5 percentage points lower	28,360	-4.37
Payroll trend	is 0.5 percentage points higher	30,047	1.31
	is 0.5 percentage points lower	29,324	-1.12
Longevity	increases by one year	30,413	2.55

The sensitivity analysis shown above considers the change in one assumption at a time, leaving the other assumptions unchanged versus the original calculation, i.e. any correlation effects between the individual assumptions are ignored.

To examine the sensitivity of the defined benefit obligation to a change in assumed longevity, the estimates of mortality were reduced as part of a comparative calculation to the extent that doing so increases life expectancy by approximately one year.

The average duration of the defined benefit obligation weighted by the present value of the defined benefit obligation (Macaulay duration) is 17 years (previous year: 18 years).

The present value of the defined benefit obligation is attributable as follows to the members of the plan:

€ million	2013	2012*
Active members with pension entitlements	15,772	16,431
Members with vested entitlements who have left the Company	1,418	1,567
Pensioners	12,468	13,186

\* Prior-year figures adjusted to reflect application of IAS 19R.

The maturity profile of payments attributable to the defined benefit obligation is presented in the following table, which classifies the present value of the obligation by the maturity of the underlying payments:

€ million	2013	2012*
Payments due within the next fiscal year	977	1,047
Payments due between two and five years	3,856	3,844
Payments due in more than five years	24,824	26,294

\* Prior-year figures adjusted to reflect application of IAS 19R.

Changes in plan assets are shown in the following table:

€ million	2013	2012
<b>Fair value of plan assets at January 1</b>	<b>7,288</b>	<b>6,559</b>
Interest income on plan assets determined using the discount rate	290	342
Income/expenses from plan assets not included in interest income	49	108
Employer contributions to plan assets	572	440
Employee contributions to plan assets	41	41
Pension payments from plan assets	222	210
Gains (+) or losses (-) arising from plan settlements	-	-
Changes in consolidated Group	0	60
Other changes	150	6
Foreign exchange differences from foreign plans	-196	-59
<b>Fair value of plan assets at December 31</b>	<b>7,970</b>	<b>7,288</b>

The investment of the plan assets to cover future pension obligations resulted in income in the amount of €338 million (previous year: €450 million).

Employer contributions to plan assets are expected to amount to €501 million in the next fiscal year (previous year: €485 million).

**CONSOLIDATED FINANCIAL STATEMENTS**  
Notes to the Consolidated Financial Statements

Plan assets are invested in the following asset classes:

€ million	DEC. 31, 2013			DEC. 31, 2012*		
	Quoted prices in active markets	No quoted prices in active markets	Total	Quoted prices in active markets	No quoted prices in active markets	Total
Cash and cash equivalents	338	–	338	478	0	478
Equity instruments	271	–	271	119	23	141
Debt instruments	1,304	0	1,305	1,353	1	1,354
Direct investments in real estate	2	82	84	–	39	39
Derivatives	17	–	17	63	–	63
Equity funds	1,812	70	1,883	1,637	59	1,696
Bond funds	2,955	86	3,041	2,467	91	2,558
Real estate funds	197	1	197	158	34	192
Other funds	317	2	319	240	–	240
Other instruments	46	469	516	95	431	526

\* Prior-year figures adjusted to reflect application of IAS 19R.

37.7% (previous year: 30.4%) of the plan assets are invested in German assets, 29.6% (previous year: 17.2%) in other European assets and 32.7% (previous years: 52.3%) in assets in other regions.

Plan assets include €22 million (previous year: €20 million) invested in Volkswagen Group assets and €19 million (previous year: €7 million) in Volkswagen Group debt instruments.

The following amounts were recognized in the income statement:

€ million	2013	2012*
Current service cost	759	573
Net interest expense (+)/income (–)	752	760
Past service cost (including plan curtailments)	4	–10
Gains (–) or losses (+) arising from plan settlements	1	0
<b>Net income (–) and expenses (+) recognized in profit or loss</b>	<b>1,516</b>	<b>1,324</b>

\* Prior-year figures adjusted to reflect application of IAS 19R.

The above amounts are generally included in the personnel costs of the functions in the income statement. Net interest expense/income from unwinding the discount on the obligation and contained in the return on plan assets is presented in finance costs.

### 30. Noncurrent and current other provisions

€ million	Obligations arising from sales	Employee expenses <sup>1</sup>	Miscellaneous provisions <sup>2</sup>	Total <sup>1,2</sup>
<b>Balance at Jan. 1, 2012</b>	<b>15,370</b>	<b>4,319</b>	<b>9,346</b>	<b>29,035</b>
Foreign exchange differences	-119	-26	-157	-302
Changes in consolidated Group	988	482	407	1,877
Utilized	6,025	2,534	2,731	11,289
Additions/New provisions	7,780	3,029	3,108	13,917
Unwinding of discount/effect of change in discount rate	246	103	5	354
Reversals	1,116	130	1,550	2,796
<b>Balance at Dec. 31, 2012</b>	<b>17,124</b>	<b>5,243</b>	<b>8,429</b>	<b>30,796</b>
of which current	8,487	3,285	4,930	16,702
of which noncurrent	8,637	1,958	3,499	14,094
<b>Balance at Jan. 1, 2013</b>	<b>17,124</b>	<b>5,243</b>	<b>8,429</b>	<b>30,796</b>
Foreign exchange differences	-417	-63	-287	-766
Changes in consolidated Group	14	5	9	28
Utilized	7,146	2,864	1,896	11,906
Additions/New provisions	9,930	3,227	3,332	16,489
Unwinding of discount/effect of change in discount rate	-33	78	3	48
Reversals	934	247	1,167	2,348
<b>Balance at Dec. 31, 2013</b>	<b>18,537</b>	<b>5,380</b>	<b>8,423</b>	<b>32,341</b>
of which current	9,655	3,377	5,327	18,360
of which noncurrent	8,882	2,003	3,096	13,981

1 Prior-year figures adjusted to reflect the application of IAS 19R.

2 Prior-period figures adjusted because of the updated purchase price allocation for MAN.

The obligations arising from sales contain provisions covering all risks relating to the sale of vehicles, components and genuine parts through to the disposal of end-of-life vehicles. They primarily comprise warranty obligations, calculated on the basis of losses to date and estimated future losses. They also include provisions for discounts, bonuses and similar allowances which are incurred after the balance sheet date, but for which there is a legal or constructive obligation attributable to sales revenue before the balance sheet date.

Provisions for employee expenses are recognized for long-service awards, time credits, partial retirement arrangements, severance payments and similar obligations, among other things.

Miscellaneous provisions relate to a wide range of identifiable specific risks and uncertain obligations, which are measured in the amount of the expected settlement value.

Miscellaneous provisions include provisions amounting to €370 million relating to the insurance business (previous year: €293 million).



### 31. Trade payables

€ million	Dec. 31, 2013	Dec. 31, 2012
Trade payables to		
third parties	17,753	16,978
affiliated companies	100	80
joint ventures	117	136
associates	47	68
other investees and investors	6	6
	<b>18,024</b>	<b>17,268</b>

### ADDITIONAL BALANCE SHEET DISCLOSURES IN ACCORDANCE WITH IFRS 7 (FINANCIAL INSTRUMENTS)

#### CARRYING AMOUNT OF FINANCIAL INSTRUMENTS BY IAS 39 MEASUREMENT CATEGORY

€ million	Dec. 31, 2013	Dec. 31, 2012
Financial assets at fair value through profit or loss	373	556
Loans and receivables	111,010	102,451
Available-for-sale financial assets	12,435	11,306
Financial liabilities at fair value through profit or loss	762	607
Financial liabilities measured at amortized cost	147,346	138,506

#### RECONCILIATION OF BALANCE SHEET ITEMS TO CLASSES OF FINANCIAL INSTRUMENTS

The following table shows the reconciliation of the balance sheet items to the relevant classes of financial instruments, broken down by the carrying amount and fair value of the financial instruments.

The fair value of financial instruments measured at amortized cost, such as receivables and liabilities, is calculated by discounting using a market rate of interest for a similar risk and matching maturity. For reasons of materiality, the fair value of current balance sheet items is generally deemed to be their carrying amount.

**CONSOLIDATED FINANCIAL STATEMENTS**  
*Notes to the Consolidated Financial Statements*

**RECONCILIATION OF BALANCE SHEET ITEMS TO CLASSES OF FINANCIAL INSTRUMENTS**  
**AS OF DECEMBER 31, 2012**

€ million	MEASURED AT FAIR VALUE	MEASURED AT AMORTIZED COST		NOT WITHIN SCOPE OF IFRS 7	BALANCE SHEET ITEM AT DEC. 31, 2012
	Carrying amount	Carrying amount	Fair value	Carrying amount	
<b>Noncurrent assets</b>					
Equity-accounted investments	–	–	–	7,309	7,309
Other equity investments	2,606	1,265	1,265	–	3,870
Financial services receivables	–	49,785	50,491	–	49,785
Other financial assets	2,226	4,206	4,279	–	6,431
<b>Current assets</b>					
Trade receivables	–	10,099	10,099	–	10,099
Financial services receivables	–	36,911	36,911	–	36,911
Other financial assets	832	5,041	5,041	–	5,872
Marketable securities	7,433	–	–	–	7,433
Cash, cash equivalents and time deposits	–	18,488	18,488	–	18,488
<b>Noncurrent liabilities</b>					
Noncurrent financial liabilities	–	63,603	66,183	–	63,603
Other noncurrent financial liabilities	1,587	810	816	–	2,397
<b>Current liabilities</b>					
Put options and compensation rights granted to noncontrolling interest shareholders	–	–	–	–	–
Current financial liabilities	–	54,060	54,060	–	54,060
Trade payables	–	17,268	17,268	–	17,268
Other current financial liabilities	1,230	3,195	3,195	–	4,425

CONSOLIDATED FINANCIAL STATEMENTS  
Notes to the Consolidated Financial Statements

RECONCILIATION OF BALANCE SHEET ITEMS TO CLASSES OF FINANCIAL INSTRUMENTS  
AS OF DECEMBER 31, 2013

€ million	MEASURED AT FAIR VALUE	MEASURED AT AMORTIZED COST		NOT WITHIN SCOPE OF IFRS 7	BALANCE SHEET ITEM AT DEC. 31, 2013
	Carrying amount	Carrying amount	Fair value	Carrying amount	
<b>Noncurrent assets</b>					
Equity-accounted investments	–	–	–	7,934	7,934
Other equity investments	2,666	1,274	1,274	–	3,941
Financial services receivables	–	51,198	53,200	–	51,198
Other financial assets	2,414	4,626	4,593	–	7,040
<b>Current assets</b>					
Trade receivables	–	11,133	11,133	–	11,133
Financial services receivables	–	38,386	38,386	–	38,386
Other financial assets	1,680	4,911	4,911	–	6,591
Marketable securities	8,492	–	–	–	8,492
Cash, cash equivalents and time deposits	–	23,178	23,178	–	23,178
<b>Noncurrent liabilities</b>					
Noncurrent financial liabilities	–	61,517	62,810	–	61,517
Other noncurrent financial liabilities	1,169	1,136	1,153	–	2,305
<b>Current liabilities</b>					
Put options and compensation rights granted to noncontrolling interest shareholders	–	3,638	3,563	–	3,638
Current financial liabilities	–	59,987	59,987	–	59,987
Trade payables	–	18,024	18,024	–	18,024
Other current financial liabilities	1,070	3,456	3,456	–	4,526

Uniform valuation techniques and inputs are used to measure fair value. The fair value of Level 2 and 3 financial instruments is measured in the individual divisions on the basis of Group-wide specifications. The measurement techniques used are explained in the disclosures on “accounting policies”. The fair value of put options and compensation rights granted to noncontrolling interest shareholders is calculated using a present value model based on the contractually agreed cash settlement, including cash compensation, as well as the minimum statutory interest rate and a risk-adjusted discount rate for a matching maturity. For further information, please see the disclosures on the basis of consolidation. The fair value of Level 3 receivables was measured by reference to individual expectations of losses; these are based to a significant extent on the Company’s assumptions about counterparty credit quality.

**CONSOLIDATED FINANCIAL STATEMENTS**  
Notes to the Consolidated Financial Statements

The following table contains an overview of the financial assets and liabilities measured at fair value by level:

**FINANCIAL ASSETS AND LIABILITIES MEASURED AT FAIR VALUE BY LEVEL**

€ million	Dec. 31, 2012	Level 1	Level 2	Level 3
<b>Financial assets at fair value through profit or loss</b>				
Derivatives	3,057	–	2,939	119
<b>Available-for-sale financial assets</b>				
Other equity investments	2,606	2,606	–	–
Marketable securities	7,433	7,419	14	–
<b>Financial assets measured at fair value</b>	<b>13,096</b>	<b>10,025</b>	<b>2,953</b>	<b>119</b>
<b>Financial liabilities at fair value through profit or loss</b>				
Derivatives	2,818	–	2,757	60
<b>Financial liabilities measured at fair value</b>	<b>2,818</b>	<b>–</b>	<b>2,757</b>	<b>60</b>

€ million	Dec. 31, 2013	Level 1	Level 2	Level 3
<b>Financial assets at fair value through profit or loss</b>				
Derivatives	4,094	–	4,062	32
<b>Available-for-sale financial assets</b>				
Other equity investments	2,666	2,666	–	–
Marketable securities	8,492	8,410	83	–
<b>Financial assets measured at fair value</b>	<b>15,252</b>	<b>11,076</b>	<b>4,144</b>	<b>32</b>
<b>Financial liabilities at fair value through profit or loss</b>				
Derivatives	2,239	–	2,021	218
<b>Financial liabilities measured at fair value</b>	<b>2,239</b>	<b>–</b>	<b>2,021</b>	<b>218</b>

CONSOLIDATED FINANCIAL STATEMENTS  
Notes to the Consolidated Financial Statements

FAIR VALUE OF FINANCIAL ASSETS AND LIABILITIES MEASURED AT AMORTIZED COST BY LEVEL

€ million	Dec. 31, 2012	Level 1	Level 2	Level 3
Fair value of financial assets measured at amortized cost				
Other equity investments	1,265	–	226	1,039
Financial services receivables	87,402	–	85,361	2,041
Trade receivables	10,099	–	9,998	100
Other financial assets	9,320	39	9,266	14
Cash, cash equivalents and time deposits	18,488	17,816	672	–
<b>Fair value of financial assets measured at amortized cost</b>	<b>126,573</b>	<b>17,855</b>	<b>105,524</b>	<b>3,195</b>
Fair value of financial liabilities measured at amortized cost				
Put options and compensation rights granted to noncontrolling interest shareholders	–	–	–	–
Trade payables	17,268	–	17,268	–
Financial liabilities	120,242	21,568	98,674	–
Other financial liabilities	4,010	2	4,003	5
<b>Fair value of financial liabilities measured at amortized cost</b>	<b>141,521</b>	<b>21,571</b>	<b>119,945</b>	<b>5</b>

€ million	Dec. 31, 2013	Level 1	Level 2	Level 3
Fair value of financial assets measured at amortized cost				
Other equity investments	1,274	–	186	1,088
Financial services receivables	91,586	–	89,889	1,698
Trade receivables	11,133	–	10,999	134
Other financial assets	9,504	166	9,313	26
Cash, cash equivalents and time deposits	23,178	22,013	1,165	–
<b>Fair value of financial assets measured at amortized cost</b>	<b>136,675</b>	<b>22,179</b>	<b>111,551</b>	<b>2,945</b>
Fair value of financial liabilities measured at amortized cost				
Put options and compensation rights granted to noncontrolling interest shareholders	3,563	–	–	3,563
Trade payables	18,024	–	18,024	–
Financial liabilities	122,797	20,905	101,728	165
Other financial liabilities	4,609	63	4,507	40
<b>Fair value of financial liabilities measured at amortized cost</b>	<b>148,993</b>	<b>20,967</b>	<b>124,258</b>	<b>3,768</b>

**CONSOLIDATED FINANCIAL STATEMENTS**  
*Notes to the Consolidated Financial Statements*

The allocation of fair values to the three levels in the fair value hierarchy is based on the availability of observable market prices in an active market. Level 1 is used to report the fair value of financial instruments for which a quoted price is available. Examples include marketable securities and other equity investments measured at fair value. Fair values in Level 2, e.g. of derivatives, are measured on the basis of market inputs such as exchange rates or yield curves using market-based valuation techniques. Level 3 fair values are calculated using valuation techniques that incorporate inputs that are not directly observable in active markets. In the Volkswagen Group, Level 3 fair values comprise long-term commodity futures because the prices available on the market must be extrapolated for measurement purposes. Options on equity instruments and residual value protection models are also reported in Level 3.

**CHANGES IN BALANCE SHEET ITEMS MEASURED AT FAIR VALUE BASED ON LEVEL 3**

€ million	Financial assets measured at fair value	Financial liabilities measured at fair value
<b>Balance at Jan. 1, 2012</b>	<b>8,584</b>	<b>595</b>
Foreign exchange differences	0	0
Total comprehensive income	1,784	486
recognized in profit or loss	1,785	423
recognized in other comprehensive income	-1	63
Additions (purchases)	-	-
Sales and settlements	-10,199	21
Transfers into Level 2	-51	-28
<b>Balance at Dec. 31, 2012</b>	<b>119</b>	<b>60</b>
<b>Total gains or losses recognized in profit or loss</b>	<b>1,785</b>	<b>423</b>
Net other operating expense/income	9	-3
of which attributable to assets/liabilities held at the reporting date	-13	24
Financial result	1,776	426
of which attributable to assets/liabilities held at the reporting date	3	-228

**CONSOLIDATED FINANCIAL STATEMENTS**  
Notes to the Consolidated Financial Statements

€ million	Financial assets measured at fair value	Financial liabilities measured at fair value
<b>Balance at Jan. 1, 2013</b>	<b>119</b>	<b>60</b>
Foreign exchange differences	0	0
Total comprehensive income	-70	-197
recognized in profit or loss	-63	-182
recognized in other comprehensive income	-7	-16
Additions (purchases)	2	2
Sales and settlements	-8	20
Transfers into Level 2	-11	-22
<b>Balance at Dec. 31, 2013</b>	<b>32</b>	<b>218</b>
<b>Total gains or losses recognized in profit or loss</b>	<b>-63</b>	<b>-182</b>
Net other operating expense/income	-	-
of which attributable to assets/liabilities held at the reporting date	-	-
Financial result	-63	-182
of which attributable to assets/liabilities held at the reporting date	-65	-184

The transfers between the levels of the fair value hierarchy are reported at the respective reporting dates. The transfers out of Level 3 into Level 2 comprise commodity futures for which observable quoted prices are now available again for measurement purposes due to the decline in their remaining maturities; consequently, no extrapolation is required. There were no transfers between other levels of the fair value hierarchy.

Commodity prices are the key risk variable for the fair value of commodity futures. Sensitivity analyses are used to present the effect of changes in commodity prices on profit after tax and equity.

If commodity prices for commodity futures classified as Level 3 had been 10% higher (lower) as of December 31, 2013, profit would have been €6 million (previous year: €4 million) higher (lower) and equity would have been €9 million (previous year: €18 million) higher (lower).

The key risk variable for measuring options on equity instruments held by the Company is the relevant enterprise value. Sensitivity analyses are used to present the effect of changes in risk variables on profit.

If the assumed enterprise values had been 10% higher, profit would have been €12 million (previous year: €14 million) higher. If the assumed enterprise values had been 10% lower, profit would have been €21 million (previous year: €25 million) lower.

Residual value risks result from hedging agreements with dealers under which earnings effects caused by market-related fluctuations in residual values that arise from buy-back obligations under leases are borne in part by the Volkswagen Group.

The key risk variable influencing the fair value of the options relating to residual value risks is used car prices. Sensitivity analyses are used to quantify the effects of changes in used car prices on earnings after tax.

If the prices for the used cars covered by the residual value protection model had been 10% higher as of December 31, 2013, profit after tax would have been €169 million higher. If the prices for the used cars covered by the residual value protection model had been 10% lower as of December 31, 2013, profit after tax would have been €169 million lower.

**CONSOLIDATED FINANCIAL STATEMENTS**  
Notes to the Consolidated Financial Statements

**OFFSETTING OF FINANCIAL ASSETS AND LIABILITIES**

The following tables contain information about the effects of offsetting in the balance sheet and the potential financial effects of offsetting in the case of instruments that are subject to a legally enforceable master netting arrangement or a similar agreement.

€ million	Gross amounts of recognized financial assets	Gross amounts of recognized financial liabilities set off in the balance sheet	Net amounts of financial assets presented in the balance sheet	AMOUNTS THAT ARE NOT SET OFF IN THE BALANCE SHEET		Net amount at Dec. 31, 2012
				Financial instruments	Collateral received	
Derivatives	3,057	–	3,057	–1,833	–	1,224
Financial services receivables	86,958	–262	86,696	–	–35	86,661
Trade receivables	10,198	–99	10,099	0	–290	9,808
Marketable securities	7,433	–	7,433	–	–	7,433
Cash, cash equivalents and time deposits	18,488	–	18,488	–	–	18,488
Other financial assets	13,197	–80	13,117	–3	–	13,114

€ million	Gross amounts of recognized financial assets	Gross amounts of recognized financial liabilities set off in the balance sheet	Net amounts of financial assets presented in the balance sheet	AMOUNTS THAT ARE NOT SET OFF IN THE BALANCE SHEET		Net amount at Dec. 31, 2013
				Financial instruments	Collateral received	
Derivatives	4,094	–	4,094	–1,101	–	2,992
Financial services receivables	89,870	–286	89,584	–	–31	89,554
Trade receivables	11,269	–135	11,133	0	–348	10,786
Marketable securities	8,492	–	8,492	–	–	8,492
Cash, cash equivalents and time deposits	23,178	–	23,178	–	–	23,178
Other financial assets	13,520	–42	13,478	–1	–	13,478



**CONSOLIDATED FINANCIAL STATEMENTS**  
Notes to the Consolidated Financial Statements

€ million	Gross amounts of recognized financial liabilities	Gross amounts of recognized financial assets set off in the balance sheet	Net amounts of financial liabilities presented in the balance sheet	AMOUNTS THAT ARE NOT SET OFF IN THE BALANCE SHEET		Net amount at Dec. 31, 2012
				Financial instruments	Collateral pledged	
Put options and compensation rights granted to noncontrolling interest shareholders	–	–	–	–	–	–
Derivatives	2,818	–	2,818	–1,785	–	1,032
Financial liabilities	117,663	–	117,663	–	–1,769	115,894
Trade payables	17,340	–72	17,268	0	–	17,268
Other financial liabilities	4,375	–369	4,005	–3	–	4,003

€ million	Gross amounts of recognized financial liabilities	Gross amounts of recognized financial assets set off in the balance sheet	Net amounts of financial liabilities presented in the balance sheet	AMOUNTS THAT ARE NOT SET OFF IN THE BALANCE SHEET		Net amount at Dec. 31, 2013
				Financial instruments	Collateral pledged	
Put options and compensation rights granted to noncontrolling interest shareholders	3,638	–	3,638	–	–	3,638
Derivatives	2,236	–	2,236	–1,072	–	1,165
Financial liabilities	121,504	–	121,504	–	–2,060	119,444
Trade payables	18,162	–138	18,024	–1	–	18,024
Other financial liabilities	4,921	–326	4,595	–	–	4,595

The “Financial instruments” column shows the amounts that are subject to a master netting arrangement but were not set off because they do not meet the criteria for offsetting in the balance sheet. The “Collateral received” and “Collateral pledged” columns show the amounts of cash collateral and collateral in the form of financial instruments received and pledged for the total assets and liabilities that do not meet the criteria for offsetting in the balance sheet.

**CONSOLIDATED FINANCIAL STATEMENTS**  
Notes to the Consolidated Financial Statements

**CHANGES IN CREDIT RISK VALUATION ALLOWANCES ON FINANCIAL ASSETS**

€ million	Specific valuation allowances	Portfolio-based valuation allowances	2013	Specific valuation allowances	Portfolio-based valuation allowances	2012
<b>Balance at Jan. 1</b>	<b>2,072</b>	<b>1,253</b>	<b>3,325</b>	<b>1,983</b>	<b>1,050</b>	<b>3,033</b>
Exchange rate and other changes	-75	-37	-113	-20	-13	-34
Changes in consolidated Group	2	0	2	46	13	59
Additions	887	393	1,280	901	383	1,284
Utilization	383	-	383	399	-	399
Reversals	308	133	441	416	203	619
Reclassification	43	-43	0	-23	23	0
<b>Balance at Dec. 31</b>	<b>2,237</b>	<b>1,433</b>	<b>3,670</b>	<b>2,072</b>	<b>1,253</b>	<b>3,325</b>

The valuation allowances mainly relate to the credit risks associated with the financial services business.

The trade receivables and receivables from customer financing include transferred receivables in the total amount of €17 million (previous year: €8 million) and €- million (previous year: €570 million) respectively that were not derecognized in their entirety because the credit risk remains with the Volkswagen Group. The total purchase price received of €8 million (previous year: €8 million) and €- million (previous year: €553 million) respectively is reported in financial liabilities. The fair values of the receivables and liabilities are not materially different to their carrying amounts.

## OTHER DISCLOSURES

### 32. Cash flow statement

Cash flows are presented in the cash flow statement classified into cash flows from operating activities, investing activities and financing activities, irrespective of the balance sheet classification.

Cash flows from operating activities are derived indirectly from profit before tax. Profit before tax is adjusted to eliminate noncash expenditures (mainly depreciation, amortization and impairment losses) and income. In the previous year, other noncash income and expenses included in particular income from the remeasurement of the Porsche call option amounting to €1,875 million. This results in cash flows from operating activities after accounting for changes in working capital, which also include changes in leasing and rental assets and in financial services receivables.

Investing activities include additions to property, plant and equipment and equity investments, additions to capitalized development costs and investments in securities and loans.

Financing activities include outflows of funds from dividend payments and redemption of bonds, inflows from the capital increase and issuance of bonds, and changes in other financial liabilities. Please refer to note 24 for information on the inflows from the issuance of a mandatory convertible note (€1,099 million) and hybrid capital (€1,967 million) contained in the capital contributions.

The changes in balance sheet items that are presented in the cash flow statement cannot be derived directly from the balance sheet, as the effects of currency translation and changes in the consolidated Group are noncash transactions and are therefore eliminated.

In 2013, cash flows from operating activities include interest received amounting to €5,754 million (previous year: €5,740 million) and interest paid amounting to €3,864 million (previous year: €3,915 million). In addition, the share of profits and losses of equity-accounted investments (note 7) includes dividends amounting to €2,827 million (previous year: €3,925 million).

Dividends amounting to €1,639 million (previous year: €1,406 million) were paid to Volkswagen AG shareholders.

€ million	Dec. 31, 2013	Dec. 31, 2012
Cash, cash equivalents and time deposits as reported in the balance sheet	23,178	18,488
Time deposits and restricted cash	-1,169	-694
Cash and cash equivalents as reported in the cash flow statement	22,009	17,794

Time deposits and restricted cash are not classified as cash equivalents. Time deposits have a contractual maturity of more than three months. At the reporting date, restricted cash within cash and cash equivalents as reported in the balance sheet amounted to €- million (previous year: €128 million). The maximum default risk corresponds to its carrying amount.

### 33. Financial risk management and financial instruments

#### 1. HEDGING GUIDELINES AND FINANCIAL RISK MANAGEMENT PRINCIPLES

The principles and responsibilities for managing and controlling the risks that could arise from financial instruments are defined by the Board of Management and monitored by the Supervisory Board. General rules apply to the Group-wide risk policy; these are oriented on the statutory requirements and the “Minimum Requirements for Risk Management by Credit Institutions”.

Group Treasury is responsible for operational risk management and control. The Scania subgroup is not coordinated centrally because of restrictions under stock exchange law. The integration process has not yet been completed for MAN. However, these companies have their own, well-established risk management structures. The Executive Committee for Liquidity and Foreign Currency is regularly informed about current financial risks. In addition, the Group Board of Management and the Supervisory Board are regularly updated on the current risk situation.

For more information, please see the management report on page 162.

#### 2. CREDIT AND DEFAULT RISK

The credit and default risk arising from financial assets involves the risk of default by counterparties, and therefore comprises at a maximum the amount of the claims under carrying amounts receivable from them and the irrevocable credit commitments. The maximum potential credit and default risk is reduced by collateral held and other credit enhancements in the amount of €68,763 million (previous year: €65,267 million). The collateral held relates solely to financial assets carried at amortized cost and mainly serves to secure financial services receivables and trade receivables. Collateral comprises vehicles and assets transferred as security, as well as guarantees and real property liens. Cash collateral is also used in hedging transactions. The risk arising from nonderivative financial instruments is also accounted for by recognizing bad debt losses. Significant cash and capital investments, as well as derivatives, are only entered into with national and international banks of good credit standing. Risk is additionally limited by a limit system based primarily on credit assessments by international rating agencies and on the equity base of the counterparties concerned.

There were no material concentrations of risk at individual counterparties or counterparty groups in the past fiscal year due to the global allocation of the Group’s business activities and the resulting diversification. The concentration of credit and default risk exposures to the German public banking sector as a whole that has arisen from Group-wide cash and capital investments as well as derivatives and had persisted since the previous year was reduced at the end of 2013: the portion attributable to this sector was 12.9% compared with 28.2% at the end of 2012. Any existing concentration of risk is assessed and monitored both at the level of individual counterparties or counterparty groups and with regard to the countries in which these are based, in each case using the share of all credit and default risk exposures accounted for by the risk exposure concerned.

CONSOLIDATED FINANCIAL STATEMENTS  
Notes to the Consolidated Financial Statements

CREDIT AND DEFAULT RISK RELATING TO FINANCIAL ASSETS BY GROSS CARRYING AMOUNT

€ million	Neither past due nor impaired	Past due and not impaired	Impaired	Dec. 31, 2013	Neither past due nor impaired	Past due and not impaired	Impaired	Dec. 31, 2012
Measured at amortized cost								
Financial services receivables	86,588	2,694	3,121	92,403	83,104	2,767	3,333	89,204
Trade receivables	8,219	2,814	514	11,547	7,055	3,111	378	10,544
Other receivables	9,442	84	446	9,972	8,832	73	512	9,417
	<b>104,249</b>	<b>5,592</b>	<b>4,081</b>	<b>113,922</b>	<b>98,991</b>	<b>5,951</b>	<b>4,223</b>	<b>109,165</b>

There are no past due financial instruments measured at fair value in the Volkswagen Group. In fiscal year 2013, marketable securities measured at fair value with a cost of €85 million (previous year: €85 million) were individually impaired.

CREDIT RATING OF THE GROSS CARRYING AMOUNTS OF FINANCIAL ASSETS THAT ARE NEITHER PAST DUE NOR IMPAIRED

€ million	Risk class 1	Risk class 2	Dec. 31, 2013	Risk class 1	Risk class 2	Dec. 31, 2012
Measured at amortized cost						
Financial services receivables	71,592	14,996	86,588	67,630	15,475	83,104
Trade receivables	8,218	1	8,219	7,054	1	7,055
Other receivables	9,402	40	9,442	8,796	36	8,832
Measured at fair value	12,009	–	12,009	10,108	–	10,108
	<b>101,221</b>	<b>15,037</b>	<b>116,258</b>	<b>93,587</b>	<b>15,512</b>	<b>109,099</b>

The Volkswagen Group performs a credit assessment of borrowers in all loan and lease agreements, using scoring systems for the high-volume business and rating systems for corporate customers and receivables from dealer financing. Receivables rated as good are contained in risk class 1. Receivables from customers whose credit rating is not good but have not yet defaulted are contained in risk class 2.

**MATURITY ANALYSIS OF THE GROSS CARRYING AMOUNTS OF FINANCIAL ASSETS THAT ARE PAST DUE AND NOT IMPAIRED**

€ million	PAST DUE BY			GROSS CARRYING AMOUNT
	up to 30 days	30 to 90 days	more than 90 days	Dec. 31, 2012
<b>Measured at amortized cost</b>				
Financial services receivables	2,206	536	24	2,767
Trade receivables	1,677	868	566	3,111
Other receivables	37	7	29	73
<b>Measured at fair value</b>	–	–	–	–
	<b>3,920</b>	<b>1,411</b>	<b>620</b>	<b>5,951</b>

€ million	PAST DUE BY			GROSS CARRYING AMOUNT
	up to 30 days	30 to 90 days	more than 90 days	Dec. 31, 2013
<b>Measured at amortized cost</b>				
Financial services receivables	2,011	664	19	2,694
Trade receivables	1,356	654	804	2,814
Other receivables	34	21	30	84
<b>Measured at fair value</b>	–	–	–	–
	<b>3,401</b>	<b>1,339</b>	<b>852</b>	<b>5,592</b>

Collateral that was accepted for financial assets in the current fiscal year was recognized in the balance sheet in the amount of €103 million (previous year: €129 million). This mainly relates to vehicles.

### 3. LIQUIDITY RISK

The solvency and liquidity of the Volkswagen Group are ensured at all times by rolling liquidity planning, a liquidity reserve in the form of cash, confirmed credit lines and globally available debt issuance programs. There were no significant risk concentrations in the past fiscal year.

The following overview shows the contractual undiscounted cash flows from financial instruments.

**MATURITY ANALYSIS OF UNDISCOUNTED CASH FLOWS FROM FINANCIAL INSTRUMENTS**

€ million	REMAINING CONTRACTUAL MATURITIES			2013	REMAINING CONTRACTUAL MATURITIES			2012
	under one year	within one to five years	over five years		under one year	within one to five years	over five years	
Put options and compensation rights granted to noncontrolling interest shareholders	3,638	–	–	3,638	–	–	–	–
Financial liabilities	62,263	61,233	9,565	133,062	56,609	61,032	6,273	123,914
Trade payables	18,009	14	–	18,024	17,264	4	–	17,269
Other financial liabilities	3,455	1,047	91	4,593	3,196	729	96	4,021
Derivatives	54,325	46,626	1,158	102,109	51,425	56,029	78	107,532
	<b>141,691</b>	<b>108,920</b>	<b>10,814</b>	<b>261,425</b>	<b>128,494</b>	<b>117,794</b>	<b>6,447</b>	<b>252,736</b>

Derivatives comprise both cash flows from derivative financial instruments with negative fair values and cash flows from derivatives with positive fair values for which gross settlement has been agreed. The cash outflows from derivatives for which gross settlement has been agreed are matched in part by cash inflows. These cash inflows are not reported in the maturity analysis. If these cash inflows were also recognized, the cash outflows presented would be substantially lower.

The cash outflows from irrevocable credit commitments are presented in note 37, classified by contractual maturities.

The maximum potential liability under financial guarantees amounted to €847 million as of December 31, 2013 (previous year: €846 million). Financial guarantees are assumed to be due immediately in all cases. They relate primarily to guarantees.

**4. MARKET RISK**

**4.1 Hedging policy and financial derivatives**

During the course of its general business activities, the Volkswagen Group is exposed to foreign currency, interest rate, commodity price, equity price and fund price risk. Corporate policy is to limit or eliminate such risk by means of hedging. All necessary hedging transactions with the exception of the Scania, MAN and Porsche Holding GmbH (Salzburg) subgroups are executed or coordinated centrally by Group Treasury. There were no significant risk concentrations in the past fiscal year.

The following table shows the gains and losses on hedges:

€ million	2013	2012
Hedging instruments used in fair value hedges	–340	12
Hedged items used in fair value hedges	354	–119
Ineffective portion of cash flow hedges	–47	0

The ineffective portion of cash flow hedges represents the income and expenses from changes in the fair value of hedging instruments that exceed the changes in the fair value of the hedged items but that are documented to be within the permitted range of 80% to 125% overall when measuring effectiveness. Such income or expenses are recognized directly in the financial result.

In 2013, €–142 million (previous year: €958 million) from the cash flow hedge reserve was transferred to the other operating result, increasing earnings, while €1 million (previous year: €14 million) was transferred to the financial result, reducing earnings, and €23 million (previous year: €–21 million) was included in the cost of sales, reducing earnings.

The Volkswagen Group uses two different methods to present market risk from nonderivative and derivative financial instruments in accordance with IFRS 7. For quantitative risk measurement, interest rate and foreign currency risk in the Volkswagen Financial Services subgroup are measured using a value-at-risk (VaR) model on the basis of a historical simulation, while market risk in the other Group companies is determined using a sensitivity analysis. The value-at-risk calculation indicates the size of a potential loss on the portfolio as a whole within a time horizon of 40 days, measured at a confidence level of 99%. To provide the basis for this calculation, all cash flows from nonderivative and derivative financial instruments are aggregated into an interest rate gap analysis. The historical market data used in calculating value at risk covers a period of 1,000 trading days. The sensitivity analysis calculates the effect on equity and profit or loss by modifying risk variables within the respective market risks.

#### 4.2 Market risk in the Volkswagen Group (excluding Volkswagen Financial Services)

##### 4.2.1 Foreign currency risk

Foreign currency risk in the Volkswagen Group (excluding Volkswagen Financial Services) is attributable to investments, financing measures and operating activities. Currency forwards, currency options, currency swaps and cross-currency swaps are used to limit foreign currency risk. These transactions relate to the exchange rate hedging of all material payments covering general business activities that are not made in the functional currency of the respective Group companies. The principle of matching currencies applies to the Group's financing activities.

Hedging transactions performed in 2013 as part of foreign currency risk management related primarily to the US dollar, sterling, the Chinese renminbi, the Swiss franc, the Mexican peso, the Swedish krona, the Polish zloty and the Australian dollar.

All nonfunctional currencies in which the Volkswagen Group enters into financial instruments are included as relevant risk variables in the sensitivity analysis in accordance with IFRS 7.

If the functional currencies concerned had appreciated or depreciated by 10% against the other currencies, the exchange rates shown below would have resulted in the following effects on the hedging reserve in equity and on profit after tax. It is not appropriate to add together the individual figures, since the results of the various functional currencies concerned are based on different scenarios.



**CONSOLIDATED FINANCIAL STATEMENTS**  
Notes to the Consolidated Financial Statements

€ million	DEC. 31, 2013		DEC. 31, 2012	
	+10%	-10%	+10%	-10%
<b>Exchange rate</b>				
<b>EUR/USD</b>				
Hedging reserve	1,570	-1,407	2,000	-1,863
Profit/loss after tax	-295	244	-367	266
<b>EUR/GBP</b>				
Hedging reserve	1,000	-1,000	1,200	-1,200
Profit/loss after tax	-50	50	-53	53
<b>EUR/CNY</b>				
Hedging reserve	564	-526	716	-660
Profit/loss after tax	-48	40	4	-34
<b>EUR/CHF</b>				
Hedging reserve	423	-416	385	-380
Profit/loss after tax	4	-6	-8	5
<b>EUR/SEK</b>				
Hedging reserve	122	-122	148	-148
Profit/loss after tax	-51	51	-49	49
<b>CZK/GBP</b>				
Hedging reserve	96	-96	104	-104
Profit/loss after tax	0	0	0	0
<b>EUR/CAD</b>				
Hedging reserve	82	-79	115	-113
Profit/loss after tax	-15	14	-19	15
<b>EUR/JPY</b>				
Hedging reserve	70	-69	207	-200
Profit/loss after tax	-22	22	-17	11
<b>EUR/AUD</b>				
Hedging reserve	75	-74	108	-108
Profit/loss after tax	-16	16	-7	7
<b>CZK/USD</b>				
Hedging reserve	64	-64	81	-81
Profit/loss after tax	-2	2	-2	2
<b>EUR/HUF</b>				
Hedging reserve	-64	64	-58	58
Profit/loss after tax	-2	2	2	-2
<b>GBP/USD</b>				
Hedging reserve	58	-58	54	-54
Profit/loss after tax	3	-3	1	-1
<b>GBP/CNY</b>				
Hedging reserve	41	-41	14	-14
Profit/loss after tax	8	-8	5	-5

#### 4.2.2 Interest rate risk

Interest rate risk in the Volkswagen Group (excluding Volkswagen Financial Services) results from changes in market interest rates, primarily for medium- and long-term variable interest receivables and liabilities. Interest rate swaps, cross-currency swaps and other types of interest rate contracts are entered into to hedge against this risk primarily under fair value or cash flow hedges, and depending on market conditions. Intragroup financing arrangements are mainly structured to match the maturities of their refinancing.

Interest rate risk within the meaning of IFRS 7 is calculated for these companies using sensitivity analyses. The effects of the risk-variable market rates of interest on the financial result and on equity are presented, net of tax.

If market interest rates had been 100 bps higher as of December 31, 2013, equity would have been €40 million (previous year: €126 million) lower. If market interest rates had been 100 bps lower as of December 31, 2013, equity would have been €27 million (previous year: €103 million) higher.

If market interest rates had been 100 bps higher as of December 31, 2013, profit after tax would have been €25 million (previous year: €81 million) higher. If market interest rates had been 100 bps lower as of December 31, 2013, profit after tax would have been €43 million (previous year: €67 million) lower.

#### 4.2.3 Commodity price risk

Commodity price risk in the Volkswagen Group (excluding Volkswagen Financial Services) primarily results from price fluctuations and the availability of nonferrous metals and precious metals, as well as of coal, CO<sub>2</sub> certificates and rubber. Forward transactions and swaps are entered into to limit these risks.

Hedge accounting in accordance with IAS 39 was applied in some cases to the hedging of commodity risk associated with aluminum, copper and coal.

Commodity price risk within the meaning of IFRS 7 is presented using sensitivity analyses. These show the effect on profit after tax and equity of changes in risk variables in the form of commodity prices.

If the commodity prices of the hedged metals, coal and rubber had been 10% higher (lower) as of December 31, 2013, profit after tax would have been €86 million (previous year: €114 million) higher (lower).

If the commodity prices of the hedging transactions accounted for using hedge accounting had been 10% higher (lower) as of December 31, 2013, equity would have been €49 million (previous year: €65 million) higher (lower).

#### 4.2.4 Equity and bond price risk

The Spezialfonds (special funds) launched using surplus liquidity and the equity interests measured at fair value are subject in particular to equity price and bond price risk, which can arise from fluctuations in quoted market prices, stock exchange indices and market rates of interest. The changes in bond prices resulting from variations in the market rates of interest are quantified in sections 4.2.1 and 4.2.2, as are the measurement of foreign currency and other interest rate risks arising from the special funds and the equity interests measured at fair value. As a rule, we counter the risks arising from the special funds by ensuring a broad diversification of products, issuers and regional markets when investing funds, as stipulated by our Investment Guidelines. In addition, we use exchange rate hedges in the form of futures contracts when market conditions are appropriate.

As part of the presentation of market risk, IFRS 7 requires disclosures on how hypothetical changes in risk variables affect the price of financial instruments. Potential risk variables here are in particular quoted market prices or indices, as well as interest rate changes as bond price parameters.

If share prices had been 10% higher as of December 31, 2013, equity would have been €194 million (previous year: €222 million) higher. If share prices had been 10% lower as of December 31, 2013, equity would have been €197 million (previous year: €233 million) lower.

#### 4.3 Market risk at Volkswagen Financial Services

Exchange rate risk in the Volkswagen Financial Services subgroup is mainly attributable to assets that are not denominated in the functional currency and from refinancing within operating activities. Interest rate risk relates to refinancing without matching maturities and the varying interest rate elasticity of individual asset and liability items. The risks are limited by the use of currency and interest rate hedges.

Microhedges and portfolio hedges are used for interest rate hedging. Fixed-rate assets and liabilities included in the hedging strategy are recognized at fair value, as opposed to their original subsequent measurement at amortized cost. The resulting effects in the income statement are offset by the corresponding gains and losses on the interest rate hedging instruments (swaps). Currency hedges (currency forwards and cross-currency swaps) are used to mitigate foreign currency risk. All cash flows in foreign currency are hedged.

As of December 31, 2013, the value at risk was €151 million (previous year: €87 million) for interest rate risk and €149 million (previous year: €144 million) for foreign currency risk.

The entire value at risk for interest rate and foreign currency risk at the Volkswagen Financial Services subgroup was €224 million (previous year: €155 million).

#### 5. METHODS FOR MONITORING HEDGE EFFECTIVENESS

In the Volkswagen Group, hedge effectiveness is assessed prospectively using the critical terms match method and using statistical methods in the form of a regression analysis. Retrospective analysis of effectiveness uses effectiveness tests in the form of the dollar offset method or a regression analysis.

Under the dollar offset method, the changes in value of the hedged item expressed in monetary units are compared with the changes in value of the hedging instrument expressed in monetary units.

Where regression analysis is used, the change in value of the hedged item is presented as an independent variable, and that of the hedging instrument as a dependent variable. Hedge relationships are classified as effective if they have sufficient coefficients of determination and slope factors.

#### NOTIONAL AMOUNT OF DERIVATIVES

€ million	REMAINING TERM			TOTAL NOTIONAL AMOUNT	TOTAL NOTIONAL AMOUNT
	under one year	within one to five years	over five years	Dec. 31, 2013	Dec. 31, 2012
<b>Notional amount of hedging instruments used in cash flow hedges:</b>					
Interest rate swaps	2,436	3,690	1	6,127	5,967
Currency forwards	31,544	33,822	–	65,366	82,293
Currency options	3,738	6,627	–	10,365	12,980
Currency swaps	4,487	396	–	4,883	912
Cross-currency swaps	279	1,015	–	1,293	1,538
Commodity futures contracts	280	469	–	749	884
<b>Notional amount of other derivatives:</b>					
Interest rate swaps	22,249	35,509	7,810	65,568	61,642
Interest rate option contracts	–	20	40	61	40
Currency forwards	6,057	1,019	1	7,077	7,394
Other currency options	8	28	6	42	290
Currency swaps	5,004	221	–	5,226	5,800
Cross-currency swaps	4,433	5,584	5	10,022	8,928
Commodity futures contracts	798	586	–	1,384	1,723

In addition to the derivatives used for hedging foreign currency, interest rate and price risk, the Group held options and other derivatives on equity instruments at the reporting date with a notional amount of €1.5 billion (previous year: €1.5 billion) whose remaining maturity is under one year.

Existing cash flow hedges in the notional amount of €214 million (previous year: €76 million) were discontinued because of a reduction in the projections. €1 million was transferred from the cash flow hedge reserve to the other financial result, decreasing earnings (previous year: €3 million, increasing earnings).

Items hedged under cash flow hedges are expected to be realized in accordance with the maturity buckets of the hedges reported in the table.

The fair values of the derivatives are estimated using market data at the balance sheet date as well as by appropriate valuation techniques. The following term structures were used for the calculation:

in %	EUR	USD	GBP	CNY	CHF	MXN	SEK	PLN	AUD
Interest rate for six months	0.4014	0.2579	0.5529	5.7046	0.1797	3.9575	0.9177	2.6874	2.6270
Interest rate for one year	0.4282	0.3041	0.6439	5.8818	0.2301	4.0599	0.9909	2.7217	2.6533
Interest rate for five years	1.2580	1.7530	2.1360	5.7850	0.7700	5.4150	2.1700	3.7050	3.7750
Interest rate for ten years	2.1550	3.0300	2.9860	5.8000	1.6380	6.3300	2.8575	4.2150	4.5900

### 34. Capital management

The goal of capital management is to ensure that the Group can effectively achieve its goals and strategies in the interests of shareholders, employees and other stakeholders. In particular, management focuses on generating the minimum return on invested assets in the Automotive Division that is required by the capital markets, and on increasing the return on equity in the Financial Services Division. In addition, the goals of the Financial Services Division are to meet the banking supervisory authorities' regulatory capital requirements, to support its external rating by ensuring capital adequacy and to procure equity for the growth planned in the next fiscal years. In the process, it aims overall to achieve the highest possible growth in the value of the Group and its divisions for the benefit of all the Company's stakeholder groups.

The Volkswagen Group's financial target system focuses systematically on continuously and sustainably increasing the value of the Company. In order to maximize the use of resources in the Automotive Division and to measure the success of this, we have been using value contribution, a control variable linked to the cost of capital, for a number of years.

The concept of value contribution not only allows overall performance to be measured in the Automotive Division, but also in the individual business units, projects and products. In addition, business units and product-specific investment projects can be managed operationally and strategically using the value contribution.

Equity and financial liabilities are compared in the following table:

€ million	Dec. 31, 2013	Dec. 31, 2012
<b>Equity</b>	<b>90,037</b>	<b>81,995</b>
Proportion of total equity and liabilities in %	27.8	26.5
Noncurrent financial liabilities	61,517	63,603
Current financial liabilities	59,987	54,060
<b>Total financial liabilities</b>	<b>121,504</b>	<b>117,663</b>
Proportion of total equity and liabilities in %	37.5	38.0
<b>Total equity and liabilities</b>	<b>324,333</b>	<b>309,518</b>

### 35. Contingent liabilities

€ million	Dec. 31, 2013	Dec. 31, 2012
Liabilities under guarantees	847	846
Liabilities under warranty contracts	155	96
Assets pledged as security for third-party liabilities	1,468	1,487
Other contingent liabilities	1,750	2,188
	<b>4,220</b>	<b>4,617</b>

The trust assets and liabilities of the savings and trust entities belonging to the South American subsidiaries not included in the consolidated balance sheet amount to €601 million (previous year: €511 million).

In the case of liabilities from guarantees (financial guarantee contracts), the Group is required to make specific payments if the debtors fail to meet their financial obligations.

Liabilities arising from the assets pledged as security for third-party liabilities primarily include the pledge of claims under certificates of deposit with Bankhaus Metzler in the amount of €1.5 billion to secure a loan granted to Fleet Investments B.V. by Bankhaus Metzler (please see the information on the basis of consolidation and joint ventures).

The other contingent liabilities are attributable primarily to potential liabilities arising from matters relating to taxes and customs duties, as well as to litigation and proceedings relating to suppliers, dealers, customers and employees.

### 36. Litigation

In the course of their operating activities, Volkswagen AG and the companies in which it is directly or indirectly invested become involved in legal disputes and official proceedings in Germany and internationally. In particular, such proceedings may occur in relation to suppliers, dealers, customers, employees, or investors. For the companies involved, these may result in payment or other obligations. Particularly in cases where US customers assert claims for vehicle defects individually or by way of a class action, highly cost-intensive measures may have to be taken and substantial compensation or punitive damages paid. Corresponding risks also result from US patent infringement proceedings.

Where transparent and economically viable, adequate insurance cover is taken out for these risks and appropriate provisions recognized for the remaining identifiable risks. The Company does not believe, therefore, that these risks will have a sustained effect on the economic position of the Group. However, as some risks cannot be assessed or can only be assessed to a limited extent, the possibility of loss or damage not being covered by the insured amounts and provisions cannot be ruled out.

In 2011, the European Commission opened antitrust proceedings against European truck manufacturers including MAN and Scania. The investigations continued in fiscal year 2013. As of the reporting date, it is still too early to judge whether these investigations pose any risk to Volkswagen Group companies.

Antitrust proceedings, also opened in 2011, by the Korea Fair Trade Commission (KFTC) against several truck manufacturers including MAN and Scania were brought to a close in fiscal year 2013 with decisions to impose administrative fines on all manufacturers involved. MAN and Scania are currently examining legal action against the decision to impose fines.

MAN has also launched an investigation into the extent to which irregularities occurred in the course of the handover of four-stroke marine diesel engines, and in particular whether technically calculated fuel consumption figures were externally manipulated. MAN informed the Munich Public Prosecution Office (I) about the ongoing investigation and the matter was handed to the Augsburg Public Prosecution Office. In this connection, the Augsburg Local Court imposed an administrative fine in the single-digit millions on MAN Diesel & Turbo SE. The investigations by the Augsburg Public Prosecution Office into MAN Diesel & Turbo SE were terminated on payment of this amount.

In June 2013, the Annual General Meeting of MAN SE approved the conclusion of a control and profit and loss transfer agreement between it and Truck & Bus GmbH, a subsidiary of VOLKSWAGEN AG. In July 2013, award proceedings were instituted to review the appropriateness of the cash settlement set out in the agreement in accordance with section 305 of the Aktiengesetz (AktG – German Stock Corporation Act) and the cash compensation in accordance with section 304 of the AktG. It is not uncommon for noncontrolling interest shareholders to institute such proceedings. Volkswagen continues to maintain that the results of the valuation are correct. The appropriateness of the valuation was confirmed by the audit firms engaged by the parties and by the court-appointed auditor of the agreement.

### 37. Other financial obligations

€ million	PAYABLE	PAYABLE	PAYABLE	TOTAL
	2013	2014 – 2017	after 2018	Dec. 31, 2012
Purchase commitments in respect of				
property, plant and equipment	6,755	1,170	–	7,925
intangible assets	428	98	–	525
investment property	1	–	–	1
Obligations from				
loan commitments to unconsolidated subsidiaries	95	–	–	95
irrevocable credit commitments to customers	2,747	151	284	3,183
long-term leasing and rental contracts	805	1,996	2,163	4,963
Miscellaneous other financial obligations	4,121	1,215	76	5,412

€ million	PAYABLE	PAYABLE	PAYABLE	TOTAL
	2014	2015 – 2018	after 2019	Dec. 31, 2013
Purchase commitments in respect of				
property, plant and equipment	7,391	1,267	–	8,658
intangible assets	636	290	–	925
investment property	10	–	–	10
Obligations from				
loan commitments to unconsolidated subsidiaries	107	–	–	107
irrevocable credit commitments to customers	2,918	132	298	3,348
long-term leasing and rental contracts	825	2,181	2,327	5,333
Miscellaneous other financial obligations	4,208	1,697	83	5,988

Other financial obligations from long-term leasing and rental contracts are partly offset by expected income from subleases of €902 million (previous year: €626 million).

The miscellaneous other financial obligations contain obligations under an irrevocable credit commitment in the amount of €1.3 billion to LeasePlan Corporation N.V., Amsterdam, the Netherlands, a Volkswagen Group joint venture, with a term until December 2015. The loan has not been drawn down to date.

### 38. Total audit fees of the Group auditors

Under the provisions of the Handelsgesetzbuch (HGB – German Commercial Code), Volkswagen AG is obliged to disclose the total audit fee of the Group auditors in Germany.

€ million	2013	2012
Financial statement audit services	12	12
Other assurance services	5	4
Tax advisory services	0	0
Other services	5	4
	<b>22</b>	<b>20</b>

### 39. Total expense for the period

€ million	2013	2012*
<b>Cost of materials</b>		
Cost of raw materials, consumables and supplies, purchased merchandise and services	<b>127,089</b>	<b>122,450</b>
<b>Personnel expenses</b>		
Wages and salaries	25,788	24,050
Social security, post-employment and other employee benefit costs	5,959	5,453
	<b>31,747</b>	<b>29,504</b>

\* Figures adjusted to reflect application of IAS 19R.



#### 40. Average number of employees during the year

	2013	2012
Performance-related wage-earners	222,654	222,487
Salaried staff	267,105	247,010
	<b>489,759</b>	<b>469,497</b>
of which in the passive phase of partial retirement	(9,340)	(6,386)
Vocational trainees	16,255	14,803
	<b>506,014</b>	<b>484,300</b>
Chinese manufacturing joint ventures	57,052	49,169
	<b>563,066</b>	<b>533,469</b>

#### 41. Events after the balance sheet date

There were no significant events after the end of fiscal year 2013.

## 42. Related party disclosures in accordance with IAS 24

Related parties as defined by IAS 24 are natural persons and entities that Volkswagen AG has the ability to control or on which it can exercise significant influence, or natural persons and entities that have the ability to control or exercise significant influence on Volkswagen AG, or that are influenced by another related party of Volkswagen AG.

At 50.73%, Porsche SE held the majority of the voting rights in Volkswagen AG as of the reporting date. The creation of rights of appointment for the State of Lower Saxony was resolved at the Extraordinary General Meeting of Volkswagen AG on December 3, 2009. As a result, Porsche SE can no longer appoint the majority of the members of Volkswagen AG's Supervisory Board for as long as the State of Lower Saxony holds at least 15% of Volkswagen AG's ordinary shares. However, Porsche SE has the power to participate in the operating policy decisions of the Volkswagen Group.

Porsche SE contributed its holding company operating business to Volkswagen AG by way of singular succession on August 1, 2012. A more detailed description of the transaction, including the treatment of the options on the outstanding shares of Porsche Holding Stuttgart that existed until that date, is contained in the section entitled "Basis of consolidation – Consolidated subsidiaries".

In addition, the contribution of Porsche SE's holding company operating business to Volkswagen AG has the following effects on the agreements between Porsche SE, Volkswagen AG and companies of the Porsche Holding Stuttgart Group that existed prior to the contribution and were entered into on the basis of the Comprehensive Agreement and its related implementation agreements:

- › Porsche SE had already issued an undertaking to Volkswagen AG, Porsche Holding Stuttgart and Porsche AG under an implementation agreement relating to the Comprehensive Agreement to indemnify those companies in relation to obligations arising from certain legal disputes, tax liabilities (including interest in accordance with section 233a of the Abgabenordnung (AO – German Tax Code)) and certain major losses. Unless otherwise described in the following, these indemnifications ceased to apply effective August 1, 2012 because of the contribution of Porsche SE's holding company operating business to Volkswagen AG.
- › Moreover, Porsche SE had issued various guarantees relating to Porsche Holding Stuttgart and Porsche AG to Volkswagen AG under an implementation agreement relating to the Comprehensive Agreement. Among other things, these related to the proper issuance of and full payment for shares and capital contributions, to the ownership of the shares of Porsche Holding Stuttgart and Porsche AG, and to the existence of the approvals, permissions and industrial property rights required to operate the business activities of Porsche AG. Unless otherwise described in the following, these indemnifications ceased to apply effective August 1, 2012 because of the contribution of Porsche SE's holding company operating business to Volkswagen AG.
- › Volkswagen AG continues to indemnify Porsche SE against certain financial guarantees issued by Porsche SE to creditors of the companies belonging to the Porsche Holding Stuttgart Group up to the amount of its share in the capital of Porsche Holding Stuttgart, which amounts to 100% since the contribution as of August 1, 2012. Porsche Holding Finance plc, Dublin, Ireland, was contributed to the Volkswagen Group in the course of the transfer of Porsche SE's holding company operating business. Since August 1, 2012, the indemnification therefore includes financial guarantees issued by Porsche SE to creditors of Porsche Holding Finance plc in relation to interest payments on and the repayment of bonds in the aggregate amount of €310 million. As part of the contribution of Porsche SE's holding company operating business to Volkswagen AG, Volkswagen AG undertook to assume standard market liability compensation effective August 1, 2012 for guarantees issued to external creditors, whereby it is indemnified internally.
- › Until the date of the contribution, Volkswagen AG guaranteed loans made by Porsche Holding Stuttgart or Porsche AG to Porsche SE in the case that these loans fell due and could not be recovered because of the insolvency of Porsche Holding Stuttgart or Porsche AG, to the extent that these obligations could have been settled if the companies had not been insolvent on the due date by offsetting them against counterclaims against Porsche SE. As a result of the contribution of the holding company operating business, these loan liabilities were transferred to the Volkswagen Group with the effect of discharging the liability, such that Volkswagen AG can no longer have any guarantee obligations to Porsche SE.

- › Volkswagen AG continues to indemnify Porsche SE internally against claims by the Einlagensicherungsfonds (German deposit protection fund) after Porsche SE submitted an indemnification agreement required by the Bundesverband Deutscher Banken (Association of German Banks) to the Einlagensicherungsfonds in August 2009. Volkswagen AG has also undertaken to indemnify the Einlagensicherungsfonds against any losses caused by measures taken by the latter in favor of a bank in which Volkswagen AG holds a majority interest.
- › Under certain conditions, Porsche SE continues to indemnify Porsche Holding Stuttgart, Porsche AG and their legal predecessors against tax liabilities that exceed the obligations recognized in the financial statements of those companies relating to periods up to and including July 31, 2009. In return, Volkswagen AG has undertaken to pay to Porsche SE any tax benefits or tax refunds of Porsche Holding Stuttgart, Porsche AG and their legal predecessors and subsidiaries for tax assessment periods up to July 31, 2009.

Under the terms of the Comprehensive Agreement, Porsche SE and Volkswagen AG had granted each other put and call options with regard to the remaining 50.1% interest in Porsche Holding Stuttgart held by Porsche SE until the contribution of its holding company operating business to Volkswagen AG. The strike price for the two options amounted to €3,883 million and was subject to certain adjustments (see the disclosures on the basis of consolidation). In the course of the contribution, the legal position of Porsche SE under the put and call options was transferred to Volkswagen AG in each case such that the options were extinguished due to confusion of rights.

Both Volkswagen AG (if it had exercised its call option) and Porsche SE (if it had exercised its put option) had undertaken to bear the tax burden resulting from the exercise of the options and any subsequent activities in relation to the equity investment in Porsche Holding Stuttgart (e.g. from recapture taxation on the spin-off in 2007 and/or 2009). If tax benefits had accrued to Volkswagen AG, Porsche Holding Stuttgart, Porsche AG, or their respective subsidiaries as a result of recapture taxation on the spin-off in 2007 and/or 2009, the purchase price to be paid by Volkswagen AG for the transfer of the outstanding 50.1% equity investment in Porsche Holding Stuttgart if the put option had been exercised by Porsche SE would have been increased by the present value of the tax benefit. This arrangement was taken over under the terms of the contribution agreement to the effect that Porsche SE has a claim against Volkswagen AG for payment in the amount of the present value of the realizable tax benefits from any recapture taxation of the spin-off in 2007 as a result of the contribution. It was also agreed under the terms of the contribution that Porsche SE will indemnify Volkswagen AG, Porsche Holding Stuttgart and their subsidiaries against taxes if measures taken by or not taken by Porsche SE result in recapture taxation for 2012 at these companies in the course of or following implementation of the contribution. In this case, too, Porsche SE is entitled to assert a claim for payment against Volkswagen AG in the amount of the present value of the realizable tax benefits that arise at the level of Volkswagen AG or one of its subsidiaries as a result of such a transaction.

To secure any potential remaining claims by Volkswagen AG under the agreement between Porsche SE and Volkswagen AG on the acquisition by Volkswagen AG of an interest in Porsche Holding Stuttgart, a purchase price retention mechanism had been agreed in favor of Volkswagen AG for the case that the put or call options were exercised. The corresponding agreements were extinguished in the course of the contribution of Porsche SE's holding company operating business to Volkswagen AG.

Further agreements were entered into and declarations were issued in connection with the contribution of Porsche SE's holding company operating business to Volkswagen AG, in particular:

- > Porsche SE issued various guarantees to Volkswagen AG in the course of the contribution relating to Porsche Holding Stuttgart, Porsche AG and its other transferred investees. Among other things, these relate to the proper issuance of and full payment for shares and capital contributions, and/or to the ownership of the shares of Porsche Holding Stuttgart and Porsche AG.
- > Under the terms of the contribution of its holding company operating business, Porsche SE also issued guarantees to Volkswagen AG for other assets transferred and liabilities assumed. In doing so, Porsche SE guarantees that these have not been assigned and are, in principle, free from third-party rights up to the date of completion of the contribution.
- > As a general principle, Porsche SE's liabilities for these guarantees are restricted to the consideration paid by Volkswagen AG.
- > Porsche SE indemnifies its contributed subsidiaries, Porsche Holding Stuttgart, Porsche AG and their subsidiaries against liabilities to Porsche SE that relate to the period up to and including December 31, 2011 and that exceed the obligations recognized in the financial statements of those companies for that period.
- > Porsche SE indemnifies Porsche Holding Stuttgart and Porsche AG against obligations arising from certain legal disputes; this includes the costs of an appropriate legal defense.
- > Moreover, Porsche SE indemnifies Volkswagen AG, Porsche Holding Stuttgart, Porsche AG and their subsidiaries against half of the taxes (other than taxes on income) arising at those companies in conjunction with the contribution that would not have been incurred in the event of the exercise of the call option on the shares of Porsche Holding Stuttgart that continued to be held by Porsche SE until the contribution. Volkswagen AG therefore indemnifies Porsche SE against half of such taxes that it incurs. In addition, Porsche Holding Stuttgart is indemnified against half of the land transfer tax and other costs triggered by the merger.
- > Additionally, Porsche SE and Porsche AG agreed to allocate any subsequent VAT receivables or liabilities from transactions in the period up to December 31, 2009 to the company entitled to the receivable or incurring the liability.
- > A range of information, conduct and cooperation obligations were agreed by Porsche SE and the Volkswagen Group.

According to a notification dated January 8, 2014, the State of Lower Saxony and Hannoversche Beteiligungsgesellschaft mbH, Hanover, held 20.00% of the voting rights of Volkswagen AG on December 31, 2013. As mentioned above, the General Meeting of Volkswagen AG on December 3, 2009 also resolved that the State of Lower Saxony may appoint two members of the Supervisory Board (right of appointment).

Members of the Board of Management and Supervisory Board of Volkswagen AG are members of supervisory and management boards or shareholders of other companies with which Volkswagen AG has relations in the normal course of business. All transactions with related parties are conducted on an arm's length basis.

The following tables present the amounts of supplies and services transacted, as well as outstanding receivables and liabilities, between consolidated companies of the Volkswagen Group and related parties.

**CONSOLIDATED FINANCIAL STATEMENTS**  
Notes to the Consolidated Financial Statements

**RELATED PARTIES**

€ million	SUPPLIES AND SERVICES RENDERED		SUPPLIES AND SERVICES RECEIVED	
	2013	2012	2013	2012
Porsche SE	13	5	11	3
Supervisory Board members	2	2	3	4
Board of Management members	0	0	0	1
Unconsolidated subsidiaries	909	1,084	687	771
Joint ventures and their majority interests*	13,547	14,195	1,278	1,853
Associates and their majority interests	249	354	369	436
Pension plans	3	2	0	0
Other related parties	–	0	0	0
State of Lower Saxony, its majority interests and joint ventures	8	9	2	2

\* Porsche Holding Stuttgart and its majority interests until July 31, 2012.

€ million	RECEIVABLES (INCL. COLLATERAL) FROM		LIABILITIES (INCL. OBLIGATIONS) TO	
	Dec. 31, 2013	Dec. 31, 2012	Dec. 31, 2013	Dec. 31, 2012
Porsche SE	361	862	419	896
Supervisory Board members	0	0	165	215
Board of Management members	0	0	56	51
Unconsolidated subsidiaries	1,172	950	587	456
Joint ventures and their majority interests	5,758	4,958	2,064	1,752
Associates and their majority interests	26	40	73	72
Pension plans	1	1	8	8
Other related parties	–	–	26	16
State of Lower Saxony, its majority interests and joint ventures	2	0	0	0

The tables above do not contain the dividend payments of €2,827 million (previous year: €3,925 million) received from the joint ventures and associates and dividends of €524 million (previous year: €449 million) paid to Porsche SE, nor do they contain the cash payment of €4,495 million made in connection with the contribution of Porsche SE's holding company operating business in fiscal year 2012.

The supplies and services received from Porsche SE relate mainly to standard market liability compensation for guarantees assumed. The supplies and services rendered to Porsche SE relate mainly to interest income on loans granted.

The receivables from Porsche SE comprise a loan receivable and, additionally for fiscal year 2012, a claim for payment of a corporation tax refund. The obligations to Porsche SE consist mainly of term deposits.

Obligations to joint ventures contain miscellaneous other financial obligations under an irrevocable credit commitment in the amount of €1.3 billion to LeasePlan Corporation N.V., Amsterdam, the Netherlands, a Volkswagen Group joint venture, with a term until December 2015.

As in the previous year, obligations to members of the Supervisory Board amounting to €165 million (previous year: €215 million) relate primarily to interest-bearing bank balances of Supervisory Board members that were invested at standard market terms and conditions at Volkswagen Group companies.

Outstanding balances for bonuses payable to Board of Management members existed in the amount of €51,964,300 at the end of the fiscal year (previous year: €46,520,000).

In addition to the amounts shown above, the following benefits and remuneration were recognized for the members of the Board of Management and Supervisory Board of the Volkswagen Group in the course of their activities as members of these bodies:

€	2013	2012
Short-term benefits	73,902,093	65,134,654
Post-employment benefits	6,103,278	4,253,401
	<b>80,005,371</b>	<b>69,388,055</b>

The employee representatives on the Supervisory Board are also entitled to a regular salary as set out in their employment contracts. This is based on the provisions of the Betriebsverfassungsgesetz (BetrVG – German Works Constitution Act) and represents an appropriate remuneration for their functions and activities in the Company. The same also applies to the representative of the senior executives on the Supervisory Board.

The post-employment benefits relate to additions to pension provisions for current members of the Board of Management (see note 45). The expenses shown above do not correspond to the definition of remuneration of members of the Board of Management and the Supervisory Board in accordance with the German Corporate Governance Code. Disclosures on pension provisions for members of the Board of Management can be found in note 45.

### 43. Notices and disclosure of changes regarding the ownership of voting rights in Volkswagen AG in accordance with the Wertpapierhandelsgesetz (WpHG – German Securities Trading Act)

#### PORSCHE

1) Porsche Automobil Holding SE, Stuttgart, Germany has notified us in accordance with section 21(1) of the WpHG that its share of the voting rights in Volkswagen Aktiengesellschaft, Wolfsburg, Germany, exceeded the threshold of 50% on January 5, 2009 and amounted to 50.76% (149,696,680 voting rights) at this date.

2) The following persons notified us in accordance with section 21(1) of the WpHG that their share of the voting rights in Volkswagen Aktiengesellschaft in each case exceeded the threshold of 50% on January 5, 2009 and in each case amounted to 50.76% (149,696,680 voting rights) at this date. All of the above-mentioned 149,696,680 voting rights are attributable to each of the persons making the notification in accordance with section 22(1) sentence 1 no. 1 of the WpHG. The voting rights attributed to the persons making the notifications are held via subsidiaries within the meaning of section 22(3) of the WpHG, whose attributed share of the voting rights amounts to 3% or more and whose names are given in brackets:

Mag. Josef Ahorner, Austria

(Ferdinand Porsche Privatstiftung, Salzburg/Austria; Ferdinand Porsche Holding GmbH, Salzburg/Austria; Louise Daxer-Piëch GmbH, Salzburg/Austria; Louise Daxer-Piech GmbH, Grünwald/Germany; Prof. Ferdinand Alexander Porsche GmbH, Salzburg/Austria; Ferdinand Alexander Porsche GmbH, Grünwald/Germany; Gerhard Anton Porsche GmbH, Salzburg/Austria; Gerhard Porsche GmbH, Grünwald/Germany; Familien Porsche-Daxer-Piech Beteiligung GmbH, Grünwald/Germany; Porsche Automobil Holding SE, Stuttgart/Germany),

Mag. Louise Kiesling, Austria

(Ferdinand Porsche Privatstiftung, Salzburg/Austria; Ferdinand Porsche Holding GmbH, Salzburg/Austria; Louise Daxer-Piëch GmbH, Salzburg/Austria; Louise Daxer-Piech GmbH, Grünwald/Germany; Prof. Ferdinand Alexander Porsche GmbH, Salzburg/Austria; Ferdinand Alexander Porsche GmbH, Grünwald/Germany; Gerhard Anton Porsche GmbH, Salzburg/Austria; Gerhard Porsche GmbH, Grünwald/Germany; Familien Porsche-Daxer-Piech Beteiligung GmbH, Grünwald/Germany; Porsche Automobil Holding SE, Stuttgart/Germany),

Prof. Ferdinand Alexander Porsche, Austria

(Ferdinand Porsche Privatstiftung, Salzburg/Austria; Ferdinand Porsche Holding GmbH, Salzburg/Austria; Louise Daxer-Piëch GmbH, Salzburg/Austria; Louise Daxer-Piech GmbH, Grünwald/Germany; Prof. Ferdinand Alexander Porsche GmbH, Salzburg/Austria; Ferdinand Alexander Porsche GmbH, Grünwald/Germany; Gerhard Anton Porsche GmbH, Salzburg/Austria; Gerhard Porsche GmbH, Grünwald/Germany; Familien Porsche-Daxer-Piech Beteiligung GmbH, Grünwald/Germany; Porsche Automobil Holding SE, Stuttgart/Germany),

Dr. Oliver Porsche, Austria

(Ferdinand Porsche Privatstiftung, Salzburg/Austria; Ferdinand Porsche Holding GmbH, Salzburg/Austria; Louise Daxer-Piëch GmbH, Salzburg/Austria; Louise Daxer-Piech GmbH, Grünwald/Germany; Prof. Ferdinand Alexander Porsche GmbH, Salzburg/Austria; Ferdinand Alexander Porsche GmbH, Grünwald/Germany; Gerhard Anton Porsche GmbH, Salzburg/Austria; Gerhard Porsche GmbH, Grünwald/Germany; Familien Porsche-Daxer-Piech Beteiligung GmbH, Grünwald/Germany; Porsche Automobil Holding SE, Stuttgart/Germany),

Kai Alexander Porsche, Austria

(Ferdinand Porsche Privatstiftung, Salzburg/Austria; Ferdinand Porsche Holding GmbH, Salzburg/Austria; Louise Daxer-Piëch GmbH, Salzburg/Austria; Louise Daxer-Piech GmbH, Grünwald/Germany; Prof. Ferdinand Alexander Porsche GmbH, Salzburg/Austria; Ferdinand Alexander Porsche GmbH, Grünwald/Germany; Gerhard Anton Porsche GmbH, Salzburg/Austria; Gerhard Porsche GmbH, Grünwald/Germany; Familien Porsche-Daxer-Piech Beteiligung GmbH, Grünwald/Germany; Porsche Automobil Holding SE, Stuttgart/Germany),

Mark Philipp Porsche, Austria

(Ferdinand Porsche Privatstiftung, Salzburg/Austria; Ferdinand Porsche Holding GmbH, Salzburg/Austria; Louise Daxer-Piëch GmbH, Salzburg/Austria; Louise Daxer-Piech GmbH, Grünwald/Germany; Prof. Ferdinand Alexander Porsche GmbH, Salzburg/Austria; Ferdinand Alexander Porsche GmbH, Grünwald/Germany; Gerhard Anton Porsche GmbH, Salzburg/Austria; Gerhard Porsche GmbH, Grünwald/Germany; Familien Porsche-Daxer-Piech Beteiligung GmbH, Grünwald/Germany; Porsche Automobil Holding SE, Stuttgart/Germany),

Gerhard Anton Porsche, Austria

(Ferdinand Porsche Privatstiftung, Salzburg/Austria; Ferdinand Porsche Holding GmbH, Salzburg/Austria; Louise Daxer-Piëch GmbH, Salzburg/Austria; Louise Daxer-Piech GmbH, Grünwald/Germany; Prof. Ferdinand Alexander Porsche GmbH, Salzburg/Austria; Ferdinand Alexander Porsche GmbH, Grünwald/Germany; Gerhard Anton Porsche GmbH, Salzburg/Austria; Gerhard Porsche GmbH, Grünwald/Germany; Familien Porsche-Daxer-Piech Beteiligung GmbH, Grünwald/Germany; Porsche Automobil Holding SE, Stuttgart/Germany),

Ing. Hans-Peter Porsche, Austria

(Familie Porsche Privatstiftung, Salzburg/Austria; Familie Porsche Holding GmbH, Salzburg/Austria; Ing. Hans-Peter Porsche GmbH, Salzburg/Austria; Hans-Peter Porsche GmbH, Grünwald/Germany; Familie Porsche Beteiligung GmbH, Grünwald/Germany; Porsche Automobil Holding SE, Stuttgart/Germany),

Peter Daniell Porsche, Austria

(Familie Porsche Privatstiftung, Salzburg/Austria; Familie Porsche Holding GmbH, Salzburg/Austria; Ing. Hans-Peter Porsche GmbH, Salzburg/Austria; Hans-Peter Porsche GmbH, Grünwald/Germany; Familie Porsche Beteiligung GmbH, Grünwald/Germany; Porsche Automobil Holding SE, Stuttgart/Germany),

Dr. Wolfgang Porsche, Germany

(Familie Porsche Privatstiftung, Salzburg/Austria; Familie Porsche Holding GmbH, Salzburg/Austria; Ing. Hans-Peter Porsche GmbH, Salzburg/Austria; Hans-Peter Porsche GmbH, Grünwald/Germany; Wolfgang Porsche GmbH, Grünwald/Germany; Familie Porsche Beteiligung GmbH, Grünwald/Germany; Porsche Automobil Holding SE, Stuttgart/Germany),

Ferdinand Porsche Privatstiftung, Salzburg/Austria

(Ferdinand Porsche Holding GmbH, Salzburg/Austria; Louise Daxer-Piëch GmbH, Salzburg/Austria; Louise Daxer-Piech GmbH, Grünwald/Germany; Prof. Ferdinand Alexander Porsche GmbH, Salzburg/Austria; Ferdinand Alexander Porsche GmbH, Grünwald/Germany; Gerhard Anton Porsche GmbH, Salzburg/Austria; Gerhard Porsche GmbH, Grünwald/Germany; Familien Porsche-Daxer-Piech Beteiligung GmbH, Grünwald/Germany; Porsche Automobil Holding SE, Stuttgart/Germany),

Familie Porsche Privatstiftung, Salzburg/Austria

(Familie Porsche Holding GmbH, Salzburg/Austria; Ing. Hans-Peter Porsche GmbH, Salzburg/Austria; Hans-Peter Porsche GmbH, Grünwald/Germany; Familie Porsche Beteiligung GmbH, Grünwald/Germany; Porsche Automobil Holding SE, Stuttgart/Germany),

Ferdinand Porsche Holding GmbH, Salzburg/Austria

(Louise Daxer-Piëch GmbH, Salzburg/Austria; Louise Daxer-Piech GmbH, Grünwald/Germany; Prof. Ferdinand Alexander Porsche GmbH, Salzburg/Austria; Ferdinand Alexander Porsche GmbH, Grünwald/Germany; Gerhard Anton Porsche GmbH, Salzburg/Austria; Gerhard Porsche GmbH, Grünwald/Germany; Familien Porsche-Daxer-Piech Beteiligung GmbH, Grünwald/Germany; Porsche Automobil Holding SE, Stuttgart/Germany),

Familie Porsche Holding GmbH, Salzburg/Austria

(Ing. Hans-Peter Porsche GmbH, Salzburg/Austria; Hans-Peter Porsche GmbH, Grünwald/Germany; Familie Porsche Beteiligung GmbH, Grünwald/Germany; Porsche Automobil Holding SE, Stuttgart/Germany),



Louise Daxer-Piëch GmbH, Salzburg/Austria  
(Louise Daxer-Piech GmbH, Grünwald/Germany; Porsche Automobil Holding SE, Stuttgart/Germany; Familien Porsche-Daxer-Piech Beteiligung GmbH, Grünwald/Germany),

Prof. Ferdinand Alexander Porsche GmbH, Salzburg/Austria  
(Ferdinand Alexander Porsche GmbH, Grünwald/Germany; Familien Porsche-Daxer-Piech Beteiligung GmbH, Grünwald/Germany; Porsche Automobil Holding SE, Stuttgart/Germany),

Gerhard Anton Porsche GmbH, Salzburg/Austria  
(Gerhard Porsche GmbH, Grünwald/Germany; Familien Porsche-Daxer-Piech Beteiligung GmbH, Grünwald/Germany; Porsche Automobil Holding SE, Stuttgart/Germany),

Louise Daxer-Piech GmbH, Grünwald/Germany  
(Familien Porsche-Daxer-Piech Beteiligung GmbH, Grünwald/Germany; Porsche Automobil Holding SE, Stuttgart/Germany),

Ferdinand Alexander Porsche GmbH, Grünwald/Germany  
(Familien Porsche-Daxer-Piech Beteiligung GmbH, Grünwald/Germany; Porsche Automobil Holding SE, Stuttgart/Germany),

Gerhard Porsche GmbH, Grünwald/Germany  
(Familien Porsche-Daxer-Piech Beteiligung GmbH, Grünwald/Germany; Porsche Automobil Holding SE, Stuttgart/Germany),

Ing. Hans-Peter Porsche GmbH, Salzburg/Austria  
(Hans-Peter Porsche GmbH, Grünwald/Germany; Familie Porsche Beteiligung GmbH, Grünwald/Germany; Porsche Automobil Holding SE, Stuttgart/Germany),

Hans-Peter Porsche GmbH, Grünwald/Germany  
(Familie Porsche Beteiligung GmbH, Grünwald/Germany; Porsche Automobil Holding SE, Stuttgart/Germany),

Wolfgang Porsche GmbH, Grünwald/Germany  
(Familie Porsche Beteiligung GmbH, Grünwald/Germany; Porsche Automobil Holding SE, Stuttgart/Germany),

Familien Porsche-Daxer-Piech Beteiligung GmbH, Grünwald/Germany  
(Porsche Automobil Holding SE, Stuttgart/Germany),

Familie Porsche Beteiligung GmbH, Grünwald/Germany  
(Porsche Automobil Holding SE, Stuttgart/Germany),

Porsche GmbH, Stuttgart/Germany  
(Porsche Automobil Holding SE, Stuttgart/Germany),

Dr. Hans Michel Piëch, Austria  
(Porsche Automobil Holding SE, Stuttgart/Germany; Hans Michel Piech GmbH, Grünwald/Germany; Dr. Hans Michel Piëch GmbH, Salzburg/Austria),

Dr. Hans Michel Piëch GmbH, Salzburg/Austria  
(Porsche Automobil Holding SE, Stuttgart/Germany; Hans Michel Piech GmbH, Grünwald/Germany),

Hans Michel Piech GmbH, Grünwald/Germany  
(Porsche Automobil Holding SE, Stuttgart/Germany),

Dipl.-Ing. Dr. h.c. Ferdinand Piëch, Austria  
(Porsche Automobil Holding SE, Stuttgart/Germany; Ferdinand Piech GmbH, Grünwald/Germany;  
Dipl.-Ing. Dr. h.c. Ferdinand Piëch GmbH, Salzburg/Austria; Ferdinand Karl Alpha Privatstiftung, Vienna/Austria),

Ferdinand Karl Alpha Privatstiftung, Vienna/Austria  
(Porsche Automobil Holding SE, Stuttgart/Germany; Ferdinand Piech GmbH, Grünwald/Germany;  
Dipl.-Ing. Dr. h.c. Ferdinand Piëch GmbH, Salzburg/Austria),

Dipl.-Ing. Dr. h.c. Ferdinand Piëch GmbH, Salzburg/Austria  
(Porsche Automobil Holding SE, Stuttgart/Germany; Ferdinand Piech GmbH, Grünwald/Germany),

Ferdinand Piech GmbH, Grünwald/Germany  
(Porsche Automobil Holding SE, Stuttgart/Germany).

- 3) Porsche Holding Gesellschaft m.b.H., Salzburg/Austria, and Porsche GmbH, Salzburg/Austria, notified us in accordance with section 21(1) of the WpHG that their share of the voting rights in Volkswagen Aktiengesellschaft in each case exceeded the threshold of 50% on January 5, 2009 and in each case amounted to 53.13% (156,702,015 voting rights) at this date.

All the above-mentioned 156,702,015 voting rights are attributable to Porsche Holding Gesellschaft m.b.H. in accordance with section 22(1) sentence 1 no. 1 of the WpHG. The companies via which the voting rights are actually held and whose attributed share of the voting rights amounts to 3% or more are:

- Porsche GmbH, Salzburg/Austria;
- Porsche GmbH, Stuttgart/Germany;
- Porsche Automobil Holding SE, Stuttgart/Germany.

Of the above-mentioned 156,702,015 voting rights, 50.76% of the voting rights (149,696,753 voting rights) are attributable to Porsche GmbH, Salzburg/Austria, in accordance with section 22(1) sentence 1 no. 1 of the WpHG. The companies via which the voting rights are actually held and whose attributed share of the voting rights amounts to 3% or more are:

- Porsche GmbH, Stuttgart/Germany;
- Porsche Automobil Holding SE, Stuttgart/Germany.

- 4) Porsche Wolfgang 1. Beteiligungs GmbH & Co. KG, Stuttgart, Germany has notified us in accordance with section 21(1) of the WpHG that its (indirect) share of the voting rights in Volkswagen Aktiengesellschaft, Wolfsburg, Germany, exceeded the thresholds of 3%, 5%, 10%, 15%, 20%, 25%, 30% and 50% of the voting rights on September 29, 2010 and amounted to 50.74% of the voting rights (149,696,680 voting rights) at this date.

Of this figure, 50.74% of the voting rights (149,696,680 voting rights) are attributable to Porsche Wolfgang 1. Beteiligungs GmbH & Co. KG in accordance with section 22(1) sentence 1 no. 1 of the WpHG.

The voting rights attributed to Porsche Wolfgang 1. Beteiligungs GmbH & Co. KG are held via the following enterprises controlled by it, whose share of the voting rights in Volkswagen Aktiengesellschaft amounts to 3% or more in each case: Wolfgang Porsche GmbH, Grünwald, Familie Porsche Beteiligung GmbH, Grünwald, Porsche Automobil Holding SE, Stuttgart.

5) We received the following notification in accordance with article 25 WpHG on February 1, 2013:

1. Issuer: VOLKSWAGEN AKTIENGESELLSCHAFT, Berliner Ring 2, 38440 Wolfsburg, Germany
2. Notifying party: Porsche Piech Holding GmbH, Salzburg, Austria
3. Reason for notification: threshold exceeded
4. Notification thresholds affected: 5%, 10%, 15%, 20%, 25%, 30%, 50%
5. Date threshold exceeded: January 31, 2013
6. Reportable share of voting rights: 53.10% (corresponds to 156,701,942 voting rights)
7. Further information on the share of voting rights:

Share of voting rights resulting from (financial/other) instruments in accordance with article 25 WpHG: 2.00%  
(corresponds to 5,901,796 voting rights)

of which held indirectly: 2.00% (corresponds to 5,901,796 voting rights)

Share of voting rights in accordance with articles 21 and 22 WpHG: 53.10% (corresponds to 156,701,942 voting rights)

8. Further information on (financial/other) instruments in accordance with Article 25 WpHG:  
Chain of controlled companies: Porsche Gesellschaft m.b.H., Salzburg; Porsche Piech GmbH & Co. KG, Salzburg  
Exercise period: from December 31, 2022

- 6) We received the following notification in accordance with article 25 WpHG on February 1, 2013:
1. Issuer: VOLKSWAGEN AKTIENGESELLSCHAFT, Berliner Ring 2, 38440 Wolfsburg, Germany
  2. Notifying party: Porsche Gesellschaft m.b.H., Salzburg, Austria
  3. Reason for notification: threshold exceeded
  4. Notification thresholds affected: 5%, 10%, 15%, 20%, 25%, 30%, 50%
  5. Date threshold exceeded: January 31, 2013
  6. Reportable share of voting rights: 53.10% (corresponds to 156,701,942 voting rights)
  7. Further information on the share of voting rights:  
  
Share of voting rights resulting from (financial/other) instruments in accordance with article 25 WpHG: 2.00% (corresponds to 5,901,796 voting rights)  
  
of which held indirectly: 2.00% (corresponds to 5,901,796 voting rights)  
  
Share of voting rights in accordance with articles 21 and 22 WpHG: 53.10% (corresponds to 156,701,942 voting rights)
  8. Further information on (financial/other) instruments in accordance with Article 25 WpHG:  
Chain of controlled companies: Porsche Piech GmbH & Co. KG, Salzburg  
Exercise period: from December 31, 2022
- 7) We received the following notification in accordance with article 25a, Section 1 WpHG on August 2, 2013:
1. Issuer: VOLKSWAGEN AKTIENGESELLSCHAFT, Berliner Ring 2, 38440 Wolfsburg, Germany
  2. Notifying party: LK Holding GmbH, Salzburg, Austria
  3. Reason for notification: threshold exceeded
  4. Notification thresholds affected: 5%, 10%, 15%, 20%, 25%, 30%, 50%
  5. Date threshold exceeded: July 30, 2013
  6. Reportable share of voting rights: 50.73% (corresponds to 149,696,681 voting rights) calculated from the following total number of voting rights issued: 295,089,818

7. Further information on the share of voting rights:

Share of voting rights resulting from (financial/other) instruments in accordance with article 25a WpHG: 50.73% (corresponds to 149,696,681 voting rights)

of which held indirectly: 0% (corresponds to 0 voting rights)

Share of voting rights resulting from (financial/other) instruments in accordance with article 25 WpHG: 0% (corresponds to 0 voting rights)

of which held indirectly: 0% (corresponds to 0 voting rights)

Share of voting rights in accordance with articles 21 and 22 WpHG: 0% (corresponds to 0 voting rights)

8. Further information on (financial/other) instruments in accordance with Article 25a WpHG:

Chain of controlled companies: -

ISIN or name/description of the (financial/other) instrument: Spaltungs- und Übernahmungsvertrag

Maturity: n/a

Expiration date: n/a

8) We received the following notification in accordance with article 25a, Section 1 WpHG on August 12, 2013:

1. Issuer: VOLKSWAGEN AKTIENGESELLSCHAFT, Berliner Ring 2, 38440 Wolfsburg, Germany

2. Notifying party: LK Holding GmbH, Salzburg, Austria

3. Reason for notification: falling below threshold

4. Notification thresholds affected: 5%, 10%, 15%, 20%, 25%, 30%, 50%

5. Date threshold exceeded: August 10, 2013

6. Reportable share of voting rights: 0.00% (corresponds to 0 voting rights) calculated from the following total number of voting rights issued: 295,089,818

7. Further information on the share of voting rights:

Share of voting rights resulting from (financial/other) instruments in accordance with article 25a WpHG: 0.00% (corresponds to 0 voting rights)

of which held indirectly: 0% (corresponds to 0 voting rights)

Share of voting rights resulting from (financial/other) instruments in accordance with article 25 WpHG: 0% (corresponds to 0 voting rights)

of which held indirectly: 0% (corresponds to 0 voting rights)

Share of voting rights in accordance with articles 21 and 22 WpHG: 50.73% (corresponds to 149,696,681 voting rights)

8. Further information on (financial/other) instruments in accordance with Article 25a WpHG:

Chain of controlled companies: -

ISIN or name/description of the (financial/other) instrument: -

Maturity: -

Expiration date: -

- 9) On August 12, 2013, LK Holding GmbH, Salzburg, Austria, has notified us in accordance with article 21, section 1 of the WpHG that its share of the voting rights in VOLKSWAGEN AKTIENGESELLSCHAFT, Wolfsburg, Germany, exceeded the thresholds of 3%, 5%, 10%, 15%, 20%, 25%, 30% and 50% of the voting rights on August 10, 2013 and amounted to 50.73% of the voting rights (149,696,681 voting rights) at this date.

Of this figure, 50.73% of the voting rights (149,696,681 voting rights) are attributable to LK Holding GmbH in accordance with article 22, section 1, sentence 1 no. 1 of the WpHG.

The voting rights attributed to LK Holding GmbH are held via the following enterprises controlled by it, whose share of the voting rights in VOLKSWAGEN AKTIENGESELLSCHAFT amounts to 3% or more in each case: Porsche Automobil Holding SE, Stuttgart; Familien Porsche-Kiesling Beteiligung GmbH, Grünwald; Louise Daxer-Piech GmbH, Grünwald.

- 10) On August 12, 2013, Louise Daxer-Piech GmbH, Salzburg, Austria, has notified us in accordance with article 21, section 1 of the WpHG that its share of the voting rights in VOLKSWAGEN AKTIENGESELLSCHAFT, Wolfsburg, Germany, fell below the thresholds of 50%, 30%, 25%, 20%, 15%, 10%, 5% and 3% of the voting rights on August 10, 2013 and amounted to 0% of the voting rights (0 voting rights) at this date.

- 11) On September 11, 2013, Ahorner Alpha Beteiligungs GmbH, Grünwald, Germany, has notified us in accordance with article 21, section 1 of the WpHG that its share of the voting rights in VOLKSWAGEN AKTIENGESELLSCHAFT, Wolfsburg, Germany, exceeded the thresholds of 3%, 5%, 10%, 15%, 20%, 25%, 30% and 50% of the voting rights on September 11, 2013 and amounted to 50.73% of the voting rights (149,696,681 voting rights) at this date. Of this figure, 50.73% of the voting rights (149,696,681 voting rights) are attributable to Ahorner Alpha Beteiligungs GmbH in accordance with article 22, section 1, sentence 1 no. 1 of the WpHG.

The voting rights attributed to Ahorner Alpha Beteiligungs GmbH are held via the following enterprises controlled by it, whose share of the voting rights in VOLKSWAGEN AKTIENGESELLSCHAFT amounts to 3% or more in each case: Porsche Automobil Holding SE, Stuttgart.

- 12) On September 11, 2013, Ahorner Beta Beteiligungs GmbH, Grünwald, Germany, has notified us in accordance with article 21, section 1 of the WpHG that its share of the voting rights in VOLKSWAGEN AKTIENGESELLSCHAFT, Wolfsburg, Germany, exceeded the thresholds of 3%, 5%, 10%, 15%, 20%, 25%, 30% and 50% of the voting rights on September 11, 2013 and amounted to 50.73% of the voting rights (149,696,681 voting rights) at this date. Of this figure, 50.73% of the voting rights (149,696,681 voting rights) are attributable to Ahorner Beta Beteiligungs GmbH in accordance with article 22, section 1, sentence 1 no. 1 of the WpHG.

The voting rights attributed to Ahorner Beta Beteiligungs GmbH are held via the following enterprises controlled by it, whose share of the voting rights in VOLKSWAGEN AKTIENGESELLSCHAFT amounts to 3% or more in each case: Ahorner Alpha Beteiligungs GmbH, Grünwald; Porsche Automobil Holding SE, Stuttgart.

- 13) On September 11, 2013, Louise Daxer-Piech GmbH, Salzburg, Austria, has notified us in accordance with article 21, section 1 of the WpHG that its share of the voting rights in VOLKSWAGEN AKTIENGESELLSCHAFT, Wolfsburg, Germany, exceeded the thresholds of 3%, 5%, 10%, 15%, 20%, 25%, 30% and 50% of the voting rights on September 11, 2013 and amounted to 50.73% of the voting rights (149,696,681 voting rights) at this date. Of this figure, 50.73% of the voting rights (149,696,681 voting rights) are attributable to Louise Daxer-Piech GmbH in accordance with article 22, section 1, sentence 1 no. 1 of the WpHG.

The voting rights attributed to Louise Daxer-Piech GmbH are held via the following enterprises controlled by it, whose share of the voting rights in VOLKSWAGEN AKTIENGESELLSCHAFT amounts to 3% or more in each case: Ahorner Beta Beteiligungs GmbH, Grünwald; Ahorner Alpha Beteiligungs GmbH, Grünwald; Porsche Automobil Holding SE, Stuttgart.

- 14) On September 11, 2013, Ahorner Holding GmbH, Salzburg, Austria, has notified us in accordance with article 21, section 1 of the WpHG that its share of the voting rights in VOLKSWAGEN AKTIENGESELLSCHAFT, Wolfsburg,

September 11, 2013 and amounted to 50.73% of the voting rights (149,696,681 voting rights) at this date. Of this figure, 50.73% of the voting rights (149,696,681 voting rights) are attributable to Ahorner Holding GmbH in accordance with article 22, section 1, sentence 1 no. 1 of the WpHG.

The voting rights attributed to Ahorner Holding GmbH are held via the following enterprises controlled by it, whose share of the voting rights in VOLKSWAGEN AKTIENGESELLSCHAFT amounts to 3% or more in each case: Louise Daxer-Piech GmbH, Salzburg, Austria; Ahorner Beta Beteiligungs GmbH, Grünwald; Ahorner Alpha Beteiligungs GmbH, Grünwald; Porsche Automobil Holding SE, Stuttgart.

- 15) On December 04, 2013, Porsche Wolfgang 1. Beteiligungsverwaltungs GmbH, Stuttgart, Germany, has notified us in accordance with article 21, section 1 of the WpHG that its share of the voting rights in VOLKSWAGEN AKTIENGESELLSCHAFT, Wolfsburg, Germany, exceeded the thresholds of 3%, 5%, 10%, 15%, 20%, 25%, 30% and 50% of the voting rights on December 2, 2013 and amounted to 50.73% of the voting rights (149,696,681 voting rights) at this date. Of this figure, 50.73% of the voting rights (149,696,681 voting rights) are attributable to Porsche Wolfgang 1. Beteiligungsverwaltungs GmbH in accordance with article 22, section 1, sentence 1 no. 1 of the WpHG.

The voting rights attributed to Porsche Wolfgang 1. Beteiligungsverwaltungs GmbH are held via the following enterprises controlled by it, whose share of the voting rights in VOLKSWAGEN AKTIENGESELLSCHAFT amounts to 3% or more in each case: Porsche Wolfgang 1. Beteiligungs GmbH & Co. KG, Stuttgart; Wolfgang Porsche GmbH, Stuttgart; Familie Porsche Beteiligung GmbH, Grünwald; Porsche Automobil Holding SE, Stuttgart.

#### QATAR

We have received the following notification:

- (1) Pursuant to section 21 (1) WpHG we hereby notify for and on behalf of the State of Qatar, acting by and through the Qatar Investment Authority, Doha, Qatar, that its indirect voting rights in Volkswagen Aktiengesellschaft
- (a) exceeded the threshold of 10% on December 17, 2009 and amounted to 13.71% of the voting rights of Volkswagen Aktiengesellschaft (40,440,274 voting rights) as per this date
    - (i) 6.93% (20,429,274 voting rights) of which have been obtained by the exercise by Qatar Holding LLC of financial instruments within the meaning of section 25 (1) sentence 1 WpHG on that date granting the right to acquire shares in Volkswagen Aktiengesellschaft, and
    - (ii) all of which are attributed to the State of Qatar pursuant to section 22 (1) sentence 1 no. 1 WpHG.
  - (b) exceeded the threshold of 15% on December 18, 2009 and amounted to 17.00% of the voting rights of Volkswagen Aktiengesellschaft (50,149,012 voting rights) as per this date
    - (i) 3.29% (9,708,738 voting rights) of which have been obtained by the exercise by Qatar Holding LLC of financial instruments within the meaning of section 25 (1) sentence 1 WpHG on that date granting the right to acquire shares in Volkswagen Aktiengesellschaft, and
    - (ii) all of which are attributed to the State of Qatar pursuant to section 22 (1) sentence 1 no. 1 WpHG.

Voting rights that are attributed to the State of Qatar pursuant to lit. (a) and (b) above are held via the following entities which are controlled by it and whose attributed proportion of voting rights in Volkswagen Aktiengesellschaft amount to 3% each or more:

- (aa) Qatar Investment Authority, Doha, Qatar;
- (bb) Qatar Holding LLC, Doha, Qatar;
- (cc) Qatar Holding Luxembourg II S.à.r.l., Luxembourg, Luxembourg;
- (dd) Qatar Holding Netherlands B.V., Amsterdam, The Netherlands.

- (2) Pursuant to section 21 (1) WpHG we hereby notify for and on behalf of the Qatar Investment Authority, Doha, Qatar, that its indirect voting rights in Volkswagen Aktiengesellschaft
- (a) exceeded the threshold of 10% on December 17, 2009 and amounted to 13.71% of the voting rights of Volkswagen Aktiengesellschaft (40,440,274 voting rights) as per this date
    - (i) 6.93% (20,429,274 voting rights) of which have been obtained by the exercise by Qatar Holding LLC of financial instruments within the meaning of section 25 (1) sentence 1 WpHG on that date granting the right to acquire shares in Volkswagen Aktiengesellschaft, and
    - (ii) all of which are attributed to the Qatar Investment Authority pursuant to section 22 (1) sentence 1 no. 1 WpHG.
  - (b) exceeded the threshold of 15% on December 18, 2009 and amounted to 17.00% of the voting rights of Volkswagen Aktiengesellschaft (50,149,012 voting rights) as per this date
    - (i) 3.29% (9,708,738 voting rights) of which have been obtained by the exercise by Qatar Holding LLC of financial instruments within the meaning of section 25 (1) sentence 1 WpHG on that date granting the right to acquire shares in Volkswagen Aktiengesellschaft, and
    - (ii) all of which are attributed to the Qatar Investment Authority pursuant to section 22 (1) sentence 1 no. 1 WpHG.

Voting rights that are attributed to the Qatar Investment Authority pursuant to lit. (a) and (b) above are held via the entities as set forth in (1) (bb) through (dd) which are controlled by it and whose attributed proportion of voting rights in Volkswagen Aktiengesellschaft amount to 3% each or more.

- (3) Pursuant to section 21 (1) WpHG we hereby notify for and behalf of Qatar Holding LLC, Doha, Qatar, that its direct and indirect voting rights in Volkswagen Aktiengesellschaft
- (a) exceeded the threshold of 10% on December 17, 2009 and amounted to 13.71% of the voting rights of Volkswagen Aktiengesellschaft (40,440,274 voting rights) as per this date
    - (i) 6.93% (20,429,274 voting rights) of which have been obtained by the exercise of financial instruments within the meaning of section 25 (1) sentence 1 WpHG on that date granting the right to acquire shares in Volkswagen Aktiengesellschaft, and
    - (ii) 6.78% (20,011,000 voting rights) of which are attributed to Qatar Holding LLC pursuant to section 22 (1) sentence 1 no. 1 WpHG.
  - (b) exceeded the threshold of 15% on December 18, 2009 and amounted to 17.00% of the voting rights of Volkswagen Aktiengesellschaft (50,149,012 voting rights) as per this date
    - (i) 3.29% (9,708,738 voting rights) of which have been obtained by the exercise of financial instruments within the meaning of section 25 (1) sentence 1 WpHG on that date granting the right to acquire shares in Volkswagen Aktiengesellschaft, and
    - (ii) 6.78% (20,011,000 voting rights) of which are attributed to Qatar Holding LLC pursuant to section 22 (1) sentence 1 no. 1 WpHG.

Voting rights that are attributed to Qatar Holding LLC pursuant to lit. (a) and (b) above are held via the entities as set forth in (1) (cc) through (dd) which are controlled by it and whose attributed proportion of voting rights in Volkswagen Aktiengesellschaft amount to 3% each or more.



We have received the following notification:

- (1) Pursuant to section 21 (1) WpHG we hereby notify for and on behalf of Qatar Holding Luxembourg II S.à.r.l., Luxembourg, Luxembourg, that its indirect voting rights in Volkswagen Aktiengesellschaft exceeded the thresholds of 10% and 15% on December 18, 2009 and amounted to 17.00% of the voting rights of Volkswagen Aktiengesellschaft (50,149,012 voting rights) as per this date, all of which are attributed to Qatar Holding Luxembourg II S.à.r.l. pursuant to section 22 (1) sentence 1 no.1 WpHG.

Voting rights that are attributed to Qatar Holding Luxembourg II S.à.r.l. are held via the following entities which are controlled by it and whose attributed proportion of voting rights in Volkswagen Aktiengesellschaft amount to 3% each or more:

- (a) Qatar Holding Netherlands B.V., Amsterdam, The Netherlands;
- (b) Qatar Holding Germany GmbH, Frankfurt am Main, Germany.

- (2) Pursuant to section 21 (1) WpHG we hereby notify for and on behalf of Qatar Holding Netherlands B.V., Amsterdam, The Netherlands, that its indirect voting rights in Volkswagen Aktiengesellschaft exceeded the thresholds of 10% and 15% on December 18, 2009 and amounted to 17.00% of the voting rights of Volkswagen Aktiengesellschaft (50,149,012 voting rights) as per this date, all of which are attributed to Qatar Holding Luxembourg II S.à.r.l. pursuant to section 22 (1) sentence 1 no. 1 WpHG.

Voting rights that are attributed to Qatar Holding Netherlands B.V. are held via the entity as set forth in (1) (b) which is controlled by it and whose attributed proportion of voting rights in Volkswagen Aktiengesellschaft amounts to 3% or more.

- (3) Pursuant to section 21 (1) WpHG we hereby notify for and on behalf of Qatar Holding Germany GmbH, Frankfurt am Main, Germany, that its direct voting rights in Volkswagen Aktiengesellschaft exceeded the thresholds of 3%, 5%, 10% and 15% on December 18, 2009 and amounted to 17.00% of the voting rights of Volkswagen Aktiengesellschaft (50,149,012 voting rights) as per this date.

#### **STATE OF LOWER SAXONY**

The State of Lower Saxony notified us on January 8, 2014 that it held a total of 59,022,310 ordinary shares as of December 31, 2013. It held 440 VW ordinary shares directly and 59,021,870 ordinary shares indirectly via Hannoversche Beteiligungsgesellschaft mbH (HanBG), which is owned by the State of Lower Saxony.

#### 44. German Corporate Governance Code

On November 22, 2013, the Board of Management and Supervisory Board of Volkswagen AG issued their declaration of conformity with the German Corporate Governance Code as required by section 161 of the Aktiengesetz (AktG – German Stock Corporation Act) and made it permanently available to the shareholders of Volkswagen AG on the Company’s website at [www.volkswagenag.com/ir](http://www.volkswagenag.com/ir).

On May 15, 2013, the Board of Management and Supervisory Board of AUDI AG likewise issued their declaration of conformity with the German Corporate Governance Code and made it permanently available to the shareholders at [www.audi.com/cgk-declaration](http://www.audi.com/cgk-declaration).

In December 2013, the Executive Board and Supervisory Board of MAN SE issued their declaration of conformity with the German Corporate Governance Code as required by section 161 of the AktG and made it permanently available to the shareholders at [www.corporate.man.eu/en](http://www.corporate.man.eu/en).

The Executive and Supervisory Boards of Renk AG issued a declaration of conformity on December 13, 2013 and made it permanently available to the shareholders at [www.renk.biz/corporated-governance.html](http://www.renk.biz/corporated-governance.html).

#### 45. Remuneration of the Board of Management and the Supervisory Board

€	2013	2012
<b>Board of Management remuneration</b>		
Non-performance-related remuneration	11,638,328	9,506,343
Performance-related remuneration	52,444,300	47,000,000
<b>Supervisory Board remuneration</b>		
Fixed remuneration components	528,671	651,625
Variable remuneration components	9,245,859	8,125,886

The fixed remuneration of the Board of Management also includes differing levels of remuneration for appointments assumed at Group companies as well as the cost or cash equivalent of noncash and other benefits, such as the use of company cars and the payment of insurance premiums. Taxes due on the noncash benefits were mainly borne by Volkswagen AG. The variable remuneration paid to each member of the Board of Management comprises a bonus, which relates to business performance over the preceding two years, and, since 2010, a Long-Term Incentive (LTI) plan, which is based on the previous four fiscal years, subject to an introductory phase.

On December 31, 2013, the pension provisions for members of the Board of Management amounted to €107,676,518 (previous year: €103,535,287). Current pensions are index-linked in accordance with the index-linking of the highest collectively agreed salary insofar as the application of section 16 of the Gesetz zur Verbesserung der betrieblichen Altersversorgung (BetrAVG – German Company Pension Act) does not lead to a larger increase. Members of the Board of Management with contracts entered into on or after January 1, 2010 are entitled to payment of their normal remuneration for twelve months in the event of illness. Contracts entered into before that date grant remuneration for six months. In the event of disability, they are entitled to the retirement pension. Surviving dependents receive a widow’s pension of 66 2/3% and a 20% orphan’s pension per child based on the pension of the former member of the Board of Management.

Retired members of the Board of Management and their surviving dependents received €9,977,972 (previous year: €8,797,230). Provisions for pensions for this group of people were recognized in the amount of €140,165,675 (previous year: €146,501,307).

Interest-free advances in the total amount of €480,000 (previous year: €480,000) have been granted to members of the Board of Management. The advances will be set off against performance- related remuneration in the following year. Loans in the total amount of €25,000 (repayments in 2013: €10,833; amount outstanding: €0) had originally been granted to members of the Supervisory Board. The loans generally bore interest at a rate of 4% and had an agreed term of up to 15 years.

The individual remuneration of the members of the Board of Management and the Supervisory Board is explained in the remuneration report in the management report (see page 61). A comprehensive assessment of the individual bonus components of the LTI is also to be found there.

# Responsibility Statement

To the best of our knowledge, and in accordance with the applicable reporting principles, the consolidated financial statements give a true and fair view of the assets, liabilities, financial position and profit or loss of the Group, and the Group management report includes a fair review of the development and performance of the business and the position of the Group, together with a description of the material opportunities and risks associated with the expected development of the Group.

Wolfsburg, February 11, 2014

Volkswagen Aktiengesellschaft  
The Board of Management

  
\_\_\_\_\_  
Martin Winterkorn

  
\_\_\_\_\_  
Francisco Javier Garcia Sanz

  
\_\_\_\_\_  
Jochem Heizmann

  
\_\_\_\_\_  
Christian Klingler

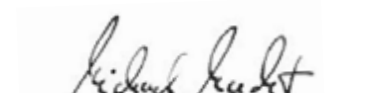
  
\_\_\_\_\_  
Michael Macht

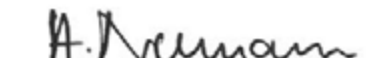
  
\_\_\_\_\_  
Horst Neumann

  
\_\_\_\_\_  
Leif Östling

  
\_\_\_\_\_  
Hans Dieter Pötsch

  
\_\_\_\_\_  
Rupert Stadler

# *Auditor's Report*

On completion of our audit, we issued the following unqualified auditor's report dated February 12, 2014. This report was originally prepared in German. In case of ambiguities the German version takes precedence:

## Auditor's Report

We have audited the consolidated financial statements prepared by VOLKSWAGEN AKTIENGESELLSCHAFT, Wolfsburg, comprising the income statement and statement of comprehensive income, the balance sheet, the statement of changes in equity, the cash flow statement and the notes to the consolidated financial statements, together with the group management report, which is combined with the management report of VOLKSWAGEN AKTIENGESELLSCHAFT, Wolfsburg, for the business year from January 1 to December 31, 2013. The preparation of the consolidated financial statements and the combined management report in accordance with the IFRSs, as adopted by the EU, and the additional requirements of German commercial law pursuant to § (article) 315a Abs. (paragraph) 1 HGB ("Handelsgesetzbuch": German Commercial Code) are the responsibility of the Company's Board of Management. Our responsibility is to express an opinion on the consolidated financial statements and the combined management report based on our audit.

We conducted our audit of the consolidated financial statements in accordance with § 317 HGB and German generally accepted standards for the audit of financial statements promulgated by the Institut der Wirtschaftsprüfer (Institute of Public Auditors in Germany) (IDW). Those standards require that we plan and perform the audit such that misstatements materially affecting the presentation of the net assets, financial position and results of operations in the consolidated financial statements in accordance with the applicable financial reporting framework and in the combined management report are detected with reasonable assurance. Knowledge of the business activities and the economic and legal environment of the Group and expectations as to possible misstatements are taken into account in the determination of audit procedures. The effectiveness of the accounting-related internal control system and the evidence supporting the disclosures in the consolidated financial statements and the combined management report are examined primarily on a test basis within the framework of the audit. The audit includes assessing the annual financial statements of those entities included in consolidation, the determination of the entities to be included in consolidation, the accounting and consolidation principles used and significant estimates made by the Company's Board of Management, as well as evaluating the overall presentation of the consolidated financial statements and the combined management report. We believe that our audit provides a reasonable basis for our opinion.

Our audit has not led to any reservations.

CONSOLIDATED FINANCIAL STATEMENTS  
*Auditors' Report*

In our opinion based on the findings of our audit the consolidated financial statements comply with the IFRSs, as adopted by the EU, and the additional requirements of German commercial law pursuant to § 315a Abs. 1 HGB and give a true and fair view of the net assets, financial position and results of operations of the Group in accordance with these provisions. The combined management report is consistent with the consolidated financial statements and as a whole provides a suitable view of the Group's position and suitably presents the opportunities and risks of future development.

Hanover, February 12, 2014

PricewaterhouseCoopers  
Aktiengesellschaft  
Wirtschaftsprüfungsgesellschaft

Harald Kayser  
German Public Auditor

Martin Schröder  
German Public Auditor

# Glossary

## Selected terms at a glance

### Association of Southeast Asian Nations (ASEAN)

An international organization of Southeast Asian nations with political, economic and cultural aims that has been in existence since August 8, 1967.

### Carbon Disclosure Project (CDP)

The aim of this non-profit organization, which was established in 2000, is to encourage companies to disclose their environmental data. Once a year, the CDP collects data on e.g. greenhouse gas emissions and climate change risks on behalf of investors.

### Completely Knocked Down (CKD)

A method of manufacturing vehicles in which kits are manufactured for export to individual countries rather than complete vehicles.

### Compliance

Adherence to statutory provisions, internal company policies and ethical principles.

### Compressed Natural Gas (CNG)

Burning this compressed natural gas releases approximately 25% less CO<sub>2</sub> than petrol because of its low carbon and high energy content.

### Continuous Improvement Process (CIP)

CIP aims to ensure the continuous optimization of product, process and service quality focused on corporate objectives. Inefficiencies are eliminated gradually and permanently and work methods are optimized through the systematic incorporation of employees' abilities and practical knowledge.

### Corporate Governance

International term for responsible corporate management and supervision driven by long-term value added.

### Direct Shift Gearbox (DSG)

Gearbox that consists of two gearboxes with a dual clutch and so combines the agility, driving pleasure and low consumption levels of a manual gearbox with the comfort of an automatic.

### Hedge accounting

Presentation of hedges in the balance sheet with the aim of compensating offsetting gains and losses from hedged items and hedging instruments within the same period economically and in the financial statements.

### Hedging instruments

Hedging transactions used in risk management, for example to hedge interest rate and exchange rate risks.

### Hybrid drive

Drive combining two different types of engine and energy storage system (usually an internal combustion engine and an electric motor).

### Modular Transverse Toolkit (MQB)

As an extension of the modular strategy, this platform can be deployed in vehicles whose architecture permits a transverse arrangement of the engine components. The modular perspective enables high synergies to be achieved between the vehicles in the Volkswagen Passenger Cars, Volkswagen Commercial Vehicles, Audi, SEAT and ŠKODA brands.

### North American Free Trade Agreement (NAFTA)

Agreement signed by Canada, Mexico and the United States establishing a free trade zone in North America in 1994.

### Penetration rate for financial services

The ratio of the leasing and financing business to total deliveries.

### Plug-in-hybrid

Next-generation hybrid vehicles. Plug-in hybrid electric vehicles (PHEVs) have a larger battery with a correspondingly higher capacity that can be charged via the combustion engine, the brake system, or an electrical outlet. This increases the range of the vehicle.

### Rating

Systematic evaluation of companies in terms of their credit quality. Ratings are expressed by means of rating classes, which are defined differently by the individual rating agencies.

### Recuperation

Recovery of kinetic energy by using an electric motor as a generator, for example in the drivetrain.

### Turntable concept

Concept of flexible manufacturing enabling the production of different models in variable daily volumes within a single plant, as well as offering the facility to vary daily production volumes of one model between two or more plants.

### Vocational groups

For example, electronics, logistics, marketing, or finance. A new teaching and learning culture is gradually being established by promoting training in the vocational groups. The specialists are actively involved in the teaching process by passing on their skills and knowledge to their colleagues.



# List of Tables

<u>A</u>		<u>D</u>		<u>M</u>	
Audi brand	27	Deliveries		MAN brand	41
Audit fees	264	- Commercial Vehicles	81	Money and capital market programs	91
		- markets	U2		
<u>B</u>		- Passenger Cars	80	<u>O</u>	
Balance sheet		- Volkswagen Group	78	Other financial obligations	263
- balance sheet disclosures in accordance					
with IFRS 7	241-250	<u>E</u>		<u>P</u>	
- cash, cash equivalents and time deposits	228	Earnings per share	212	Porsche brand	35
- Commercial Vehicles/Power Engineering	103	Employees		Proposal on the appropriation of net profit	110
- division	101	- average number of employees		Purchasing volume	121
- equity	174-175, 230	during the year	265		
- equity-accounted investments		- breakdown	135	<u>R</u>	
and other equity investments	222-223	- pay and benefits	110	Related parties	269-270
- financial liabilities	231	- proportion of women	132	Remuneration	
- financial services receivables	224-225	Environmental protection, expenditure on	111	- members of the Board	
- intangible assets	215-217			of Management	61, 63, 282
- inventories	227	<u>F</u>		- members of the Supervisory Board	64, 282
- leasing and rental assets		Financial key performance indicators	104	Research and development costs	119
and investment property	220-221	Financial risk management and		Return on investment (ROI) and value	
- other financial assets	225-226	financial instruments	253-260	contribution in the Automotive division	108
- other financial liabilities	231-232	Five-year review	106		
- other liabilities	232			<u>S</u>	
- other receivables	226	<u>I</u>		Scania brand	39
- Passenger Cars	103	Ideas management	134	SEAT brand	31
- property, plant and equipment	218-219	IFRSs, new and amended	178-179	Segment reporting	94, 202-204
- provisions	234-240	Income statement		Shares, key figures	89
- tax assets	227	- Commercial Vehicles/Power Engineering	97	ŠKODA brand	29
- tax liabilities	233	- divisions	95	Statement of changes in equity	174-175
- trade payables	241	- equity-accounted investments	207	Statement of comprehensive income	170-171
- trade receivables	227-228	- finance costs	207		
- Volkswagen AG	109	- income statements disclosures in		<u>T</u>	
- Volkswagen Group	172-173	accordance with IFRS 7	213-214	Target-performance comparison	84
Basis of consolidation	181-189	- income tax income/expense	208-211	Total expense for the period	264
Bentley brand	33	- other financial result	208		
		- other operating expenses	206	<u>V</u>	
		- other operating income	206	Value added	105
<u>C</u>		- Passenger Cars	97	Volkswagen Commercial Vehicles brand	37
Capital management	260	- sales revenue	205	Volkswagen Financial Services	46
Cash flow statement		- Volkswagen AG	109	Volkswagen Passenger Cars brand	25
- Commercial Vehicles/Power Engineering	100	- Volkswagen Group	169		
- division	99				
- Passenger Cars	100	<u>K</u>			
- Volkswagen Group	176, 251	Key figures	U1		
China, Volkswagen Group	43	- brands and business fields	23		
Contingent liabilities	261	- markets	23		
Cost of capital	107, 193				
Currency translation	191				



# Contact Information

## **PUBLISHED BY**

Volkswagen AG  
Financial Publications, Letterbox 1848-2  
38436 Wolfsburg, Germany  
Phone + 49 5361 9-0, Fax + 49 5361 9-28282

Volkswagen AG  
Group Communications, Letterbox 1970  
38436 Wolfsburg, Germany  
Phone + 49 5361 9-0, Fax + 49 5361 9-28282

*This annual report is published in English and German.  
Both versions of the report are available on the  
Internet at [www.volkswagenag.com/ir](http://www.volkswagenag.com/ir).*

## **INVESTOR RELATIONS**

Volkswagen AG  
Investor Relations, Letterbox 1849  
38436 Wolfsburg, Germany  
Phone + 49 5361 9-86622, Fax + 49 5361 9-30411  
E-mail [investor.relations@volkswagen.de](mailto:investor.relations@volkswagen.de)  
Internet [www.volkswagenag.com/ir](http://www.volkswagenag.com/ir)

Volkswagen AG  
Investor Relations  
103 Wigmore Street  
London W1U 1QS, United Kingdom  
Phone + 44 20 3693 6060

Volkswagen Group China  
No. 3A, Xi Liu Jie, Sanlitun Road  
Chaoyang District  
Beijing 100027, P.R. China  
Phone + 86 10 6531 3000

Volkswagen Group of America, Inc.  
Investor Relations Liaison Office  
(questions relating to American Depository Receipts)  
2200 Ferdinand Porsche Drive  
Herndon, Virginia 20171, USA  
Phone + 1 703 364 7000

## **CONCEPT, DESIGN AND REALIZATION**

3st kommunikation, Mainz

## **ENGLISH TRANSLATION**

Fry & Bonthron Partnerschaft, Mainz-Kastel

## **FINANCIAL REPORT**

Produced in-house with FIRE.sys

## **PRINTER**

Kunst- und Werbedruck, Bad Oeynhausen

## **PAPER**

Druckfein neu, Römerturm  
Mundoplus, Berberich Papier



ISSN 458.809.548.20  
Printed in Germany

# Scheduled Dates

2014

## MOTOR SHOWS

**March 6–16**

*International Motor Show, Geneva*

**April 7–11**

*Hanover Trade Show*

**April 18–27**

*New York International Auto Show*

**April 23–29**

*Auto China, Beijing*

**May 31–June 8**

*AMI Leipzig*

**August 28–September 7**

*MIAS, Moscow*

**October 4–19**

*International Motor Show, Paris*

**October 30–November 9**

*São Paulo International  
Motor Show*

**October 31–November 9**

*Motor Show, Istanbul*

**November 21–30**

*Los Angeles Auto Show*

## FINANCIAL CALENDAR

**March 13**

*Volkswagen AG Annual Media Conference  
and Investor Conference, Berlin*

**May 13**

*Volkswagen AG Annual General Meeting  
(Hanover Exhibition Center)*

**April 29**

*Interim Report January–March*

**July 31**

*Half-Yearly Financial Report*

**October 30**

*Interim Report January–September*



---

## *Moving diversity*

*The enclosed poster provides a snapshot of the Volkswagen Group's wide range of brands, models and markets.*



---

## *Navigator*

*For more facts and figures about the Volkswagen Group, please visit our interactive Navigator app:  
<http://navigator.volkswagenag.com>*





VOLKSWAGEN AKTIENTIENGESELLSCHAFT

MONATSUMM 2013



VOLKSWAGEN

AKTIENGESELLSCHAFT

*moving*  
ideas

MOMENTUM

*2013*





---

*Momentum* in Latin means “motive force”. It suggests a creative, innovative, inventive force – a force for good, for better.

We aim to be the world’s most sustainable car manufacturer – not just economically, but also ecologically. To achieve that, we need the momentum of constant reinvention – ideas and innovations that drive change.

We are constantly evolving, but never lose sight of our goal, which is to shape the future of mobility to the benefit of people and the environment. We have over 570,000 employees who are setting the pace of technological progress. They put all their efforts into making individual mobility even more efficient, safer and more comfortable.

We are convinced: the automobile will still be a primary mode of transport in the future. Perhaps in a different way from now, but it will be just as fascinating tomorrow as it is today.

Come and discover what moves us.

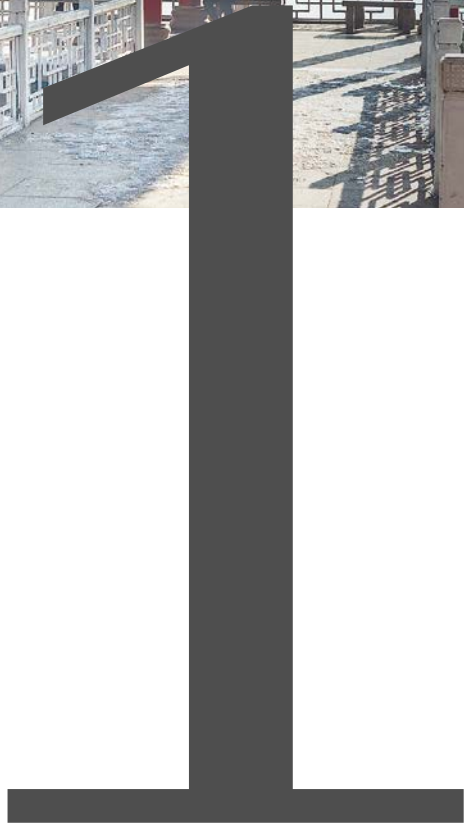

# *Understand*

THE RIGHT MOMENT\_p. 6-9

THE WORLD IN MOTION\_p. 10-15

THE LONG ROAD\_p. 16-25

2

*Act*

---

SMART DRIVING\_p. 26-31  
FUTURE FACTORY\_p. 32-37  
LESS IS MORE\_p. 38-43  
CLIMATE ZONES\_p. 44-49  
EFFICIENCY LINEUP\_p. 50-51

3

*Experience*

---

SHHH...\_p. 52-55  
LEARNING BY DOING\_p. 56-59  
SIMPLE AND CLEVER\_p. 60-61  
WITH ALL THE SENSES\_p. 62-73  
PURE FORM\_p. 74-77  
THE LAST WORD\_p. 78

# 1

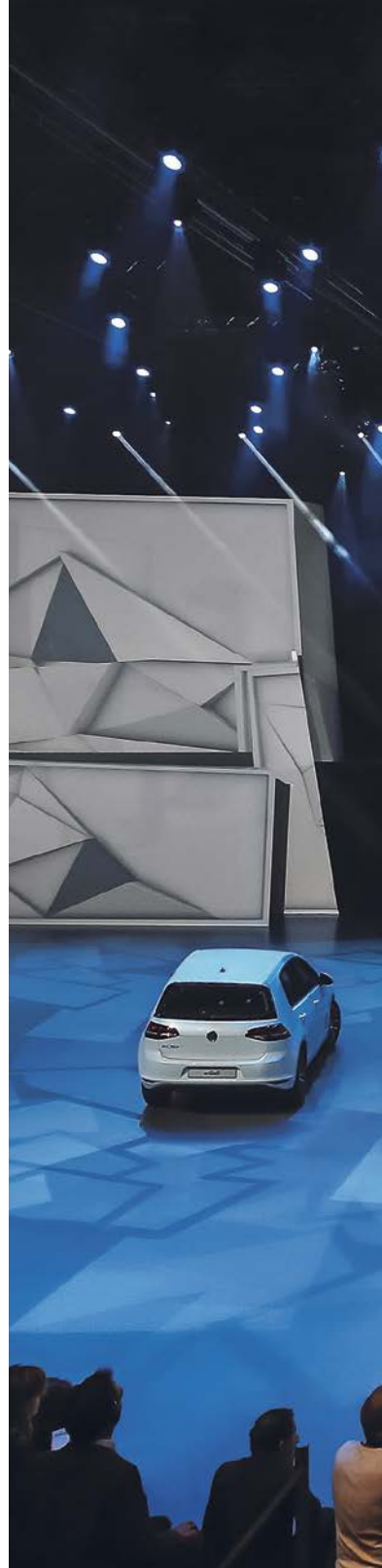

# *Understand*

1

---

Mobility must be designed to benefit people and the environment.  
The Volkswagen Group develops solutions for an automotive future in which efficiency, resource conservation and individual motoring pleasure blend into one.



---

The most important motor show in the world. On the eve of the IAA motor show 2013, Group Chairman Martin Winterkorn not only presents new models, but also announces a clear message: The age of electric vehicles has begun for the Volkswagen Group. Here he talks about a special moment along the road to becoming the ecological leader among global automobile manufacturers.

**QUESTIONS:** Johannes Winterhagen — **PHOTOGRAPHY:** Volkswagen AG



*Frankfurt am Main, September 9, 2013:  
Prof. Dr. Martin Winterkorn presents  
the Volkswagen Group's e-mobility  
campaign on the eve of the IAA motor show.*



# *The right moment*



---

*Prof. Dr. Winterkorn, how confident were you when you announced the Volkswagen Group's big e-mobility campaign in Frankfurt?*

I happily admit that taking the message to a global audience was a pretty emotional moment for me. But yes, I was very confident, not least thanks to the four electric cars that were there on the stage beside me. The e-up!<sup>1</sup> and the e-Golf<sup>2</sup>, the Audi A3 e-tron<sup>3</sup> and the Porsche Panamera S E-Hybrid<sup>4</sup> not only show how serious we are about e-mobility, but above all how fascinating and diverse this technology is.

*Why has it taken the Volkswagen Group so long to bring the first electric models to market?*

It was clear to us right from the beginning that an electric vehicle should not feel like an apology on wheels. Customers must be impressed by every aspect of the vehicle – it must be technically mature, perform well in everyday driving, and be safe and affordable. While other people were doing a lot of talking, we got on with development and did the hard work. Now the time is right.

*Don't you just need a few electric cars on the books to become the ecological leader?*

Anyone who is serious about protecting the environment must develop the whole spectrum of drive technologies: From highly efficient diesel, petrol and natural gas engines, down to plug-in hybrids and vehicles running purely on battery power. That's what our Group stands for. What's more, we think holistically about protecting the environment – from energy generation across development, production, our dealers and vehicle operation, right through to recycling. That is what "Think Blue." means for us.

*That's a lot to tackle in one go – is it really achievable?*

The whole thing is a huge challenge. But if anyone can do it, it's the Volkswagen Group with our twelve brands, our annual investment of over €10 billion in research and development, and the expertise of over 40,000 engineers. Our modular toolkits are key to making it happen. They enable us to put every drive technology into every model and every brand. What's more, we manufacture electric cars bumper to bumper with the other models in our plants.

*How do the customers – the people who buy your cars – benefit?*

The Volkswagen Group's customers really do have freedom of choice across our brands, because we are able to react quickly, flexibly and economically to every request. Take e-mobility for example: Customers can choose from emission-free city cars, through all-rounders with plug-in hybrid drives, down to sports saloons with a fuel consumption of 3 l/100 km. At Volkswagen, it's the customer who decides how much "e" they want to have in their mobility.

---

1 Volkswagen e-up! 60 kW energy consumption in kWh/100 km combined 11.7; CO<sub>2</sub> emissions in g/km combined 0.

2 Volkswagen e-Golf 85 kW energy consumption in kWh/100 km combined 12.7; CO<sub>2</sub> emissions in g/km combined 0.

3 Audi A3 Sportback e-tron 150 kW fuel consumption in l/100 km combined 1.5; CO<sub>2</sub> emissions in g/km combined 35.

4 Porsche Panamera S E-Hybrid 306 kW fuel consumption in l/100 km combined 3.1; energy consumption in kWh/100 km combined 16.2; CO<sub>2</sub> emissions in g/km combined 71.



10.2

*billion euros*

---

*The Volkswagen Group invested 10.2 billion euros in research and development in 2013.*

# The world in motion

The world of the automobile never stops – progress drives incessant change. But some things do remain constant, such as the wide range of cultures and mobility wishes among people all over the world. With around 570,000 employees in more than 150 countries, the Volkswagen Group stays close to its customers. The goal is to offer individual mobility, tailored precisely to meet the differing requirements of people everywhere – safe, environmentally friendly and with lots of motoring enjoyment.

TEXT: Tina Rumpelt



## California

The *Golden State*, land of sun, new trends and strict environmental laws.

California is looking to have 1.5 million zero emission vehicles on its roadways by 2015. The Volkswagen Group has been conducting research in Silicon Valley since 1998. Future technologies ranging from e-mobility through driver assistance systems to self-driving vehicles are being developed in the Electronics Research Laboratory (ERL) and the Volkswagen Automotive Innovation Laboratory (VAIL).

8.0

percent of new car registrations in California in 2013 had a hybrid drive, and 1.3 percent were pure-play electric vehicles.

137

million US dollars – that's how much the Volkswagen Group has invested in California since 2008, in the Test Center California (TCC) among other places. Emissions from new vehicles and drivetrains are tested there under extreme climate conditions.

### Key figures

Population	■ 38 million
Percentage of people living in cities	■ 69%
Average age of the population	■ 35 years
Number of vehicles per 1,000 inhabitants	■ 755
New vehicles registrations in 2013	■ 1.7 million cars and light trucks
Number of Volkswagen Group production facilities in the U.S.	■ 1 (in Chattanooga, Tennessee)
Group's top-selling models in the U.S.	Volkswagen Jetta and Passat, Audi Q5, Porsche Cayenne
Legal limit for CO <sub>2</sub> emissions (fleet) in the U.S.	155 g/km for 2016 model year (emissions limit declines annually)

Key figures

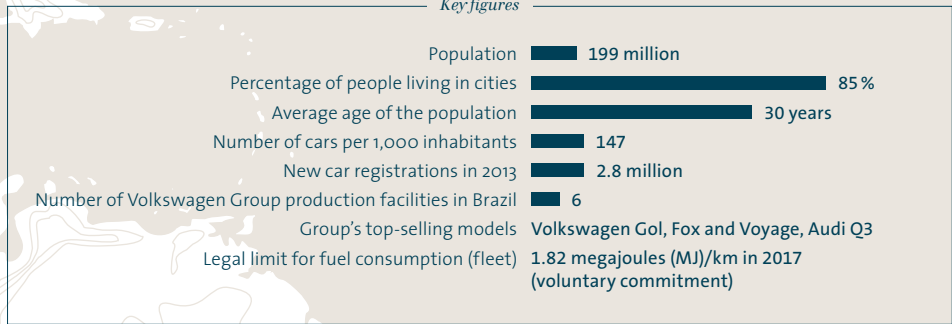

88.5

percent of all new car registrations in Brazil have flex-fuel engines – a technology that Volkswagen launched on the market in 2003.

94

percent of its energy requirements – that's how much regenerative energy Volkswagen do Brazil aims to produce going forward, using two hydroelectric power stations, among other things.

27

– the number of years the Volkswagen Gol has topped the new vehicle registrations list in Brazil.

## Brazil

The *Land of the Future*, as it is known, is the auto nation in South America. Brazil is the continent's largest vehicle exporter and the fifth-largest car market in the world. Volkswagen has had a presence in Brazil for 60 years and is now the country's leading automobile manufacturer.

The Group plans to invest €3.56 billion by 2018 to expand production capacity and develop new vehicles. From 2015 the Volkswagen Golf and Audi A3 among other models will roll off the production line in Brazil.

# European Union

Europe is the *birthplace of the automobile*. Today, 13 million people work in the automotive industry – Europe’s quintessential key industry. The Volkswagen Group is the largest vehicle manufacturer in Europe. Almost every fourth new car registered in Western Europe is produced by the Group. With 425,000 employees in 15 EU countries, plus Russia and Turkey, the company produces vehicles and components for Europe and for global markets.

Over  
**230**

– that’s the number of automobile plants in the 28 EU countries today. 62 of those belong to the Volkswagen Group.

**25**

percent of research and development expenditure is attributable to the automobile industry – some €26 billion every year. Expenditure on research and development in 2013 by the Volkswagen Group alone was over €10 billion.

**39**

percent of all new cars registered in Europe in 2012 had emissions of below 120 grams of CO<sub>2</sub> per kilometer.



### Key figures

Population	509 million
Percentage of people living in cities	74%
Average age of the population	42 years
Number of cars per 1,000 inhabitants	483
New car registrations in 2013	11.9 million
Number of Volkswagen Group production facilities in the European Union	62
Group’s top-selling models	Volkswagen Golf and Polo, Audi A3, ŠKODA Octavia
Legal limit for CO <sub>2</sub> emissions (fleet)	2012–2019: 130 g CO <sub>2</sub> /100 km 2020: 95 g CO <sub>2</sub> /100 km

Key figures

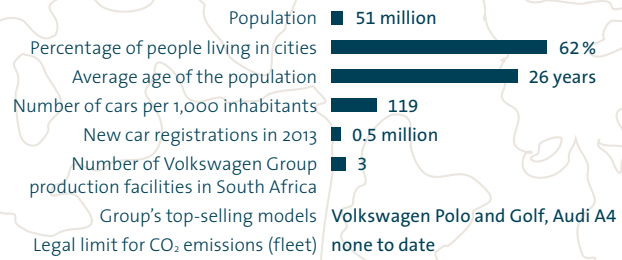

## South Africa

The *Rainbow Nation*, as it is known, is a nation of car enthusiasts – one in eight South Africans already owns a car. Volkswagen has had a presence there since 1951, and today it is number one in the South African automobile market. Around 5,300 employees work for the Group in South Africa. Volkswagen brand models leave the production line at the Uitenhage facility. In addition, MAN produces buses and trucks in Pinetown and Olifantsfontein.

Around  
**552,000**

vehicles were manufactured in South Africa in 2013, with over half destined for export.

Some  
**60**

automobile brands are present on the extremely competitive South African market.

**52**

percent of all cars sold in South Africa in 2013 were small cars. Demand in South Africa for entry-level mobility is huge.



Key figures

Population	1.24 billion
Percentage of people living in cities	32%
Average age of the population	27 years
Number of cars per 1,000 inhabitants	18
New car registrations in 2013	2.4 million
Number of Volkswagen Group production facilities in India	4
Group's top-selling models	Volkswagen Polo, Audi A4, ŠKODA Fabia
Legal limit for fuel consumption (fleet)	scheduled from 2017

## India

India is one big *up-and-coming automobile market*.

In 2013, nearly twice as many cars were sold there as in 2006. Even though the pace of economic growth has slowed down a little, the desire for mobility among the middle classes, which number some 200 million people, is unabated. The Volkswagen Group built its first plant in India in 2004 and today it manufactures cars and trucks at four sites, both for the domestic market and for export.

Some  
**4**

million cars and commercial vehicles rolled off production lines in India in 2013. This makes it the sixth-largest vehicle manufacturing country in the world.

**4-5**

billion US dollars is how much the Indian government plans to invest up to the end of the decade to promote e-mobility.

# China

The *Middle Kingdom* is the growth engine of the automobile industry and the Volkswagen Group's biggest sales market. The Company delivered over 3.27 million vehicles in China in 2013, making it the clear market leader. This success story began 30 years ago with assembly of the Santana. Today, the Group produces over 20 different models at 17 sites for the Chinese market.

About  
**87**

million cars are on the road in China – twice as many as in Germany. And still only one person in 15 in China owns a car.

**18.2**

billion euros – that's how much the Volkswagen Group joint venture companies will invest in new models, technologies and plants up to 2018.

Over  
**3,500**

scientists and engineers work in research and development for the Volkswagen Group in China.

## Key figures

Population	1.35 billion
Percentage of people living in cities	52%
Average age of the population	36 years
Number of cars per 1,000 inhabitants	64
New car registrations in 2013	15.9 million
Number of Volkswagen Group production facilities in China	17
Group's top-selling models	Volkswagen Bora, Lavida and Santana, Audi A6 L, Porsche Cayenne
Legal limit for fuel consumption (fleet)	from 2015: 6.9 l/100 km from 2020: 5.0 l/100 km

Source: The World Fact Book: [www.cia.gov](http://www.cia.gov); World Bank: [www.worldbank.org](http://www.worldbank.org); US Census Bureau: [www.census.gov](http://www.census.gov); Organisation Internationale des Constructeurs d'Automobiles: [www.oica.net](http://www.oica.net); IHS Automotive: [www.ihs.com](http://www.ihs.com); California Environmental Protection Agency: [www.arb.ca.gov](http://www.arb.ca.gov); California Government: [www.gov.ca.gov](http://www.gov.ca.gov); Associação Nacional dos Fabricantes de Veículos Automotores: [www.anfavea.com.br](http://www.anfavea.com.br); Germany Trade & Invest: [www.gtai.de](http://www.gtai.de); ACEA/The Automobile Industry Pocket Guide 2013: [www.acea.be](http://www.acea.be); Eurostat: [www.epp.eurostat.ec.europa.eu](http://www.epp.eurostat.ec.europa.eu); VDA: [www.vda.de](http://www.vda.de); National Association of Automobile Manufacturers of South Africa: [www.naamsa.co.za](http://www.naamsa.co.za).



---

**VOLKSWAGEN XL1**

*The one-liter car: TDI engine (35 kW/48 PS) combined with an electric drive (20 kW/27 PS). CO<sub>2</sub> emissions: 21 g/km*



# *The long road*

---

There's no single route towards sustainable mobility. That's why Volkswagen Group researchers and developers are working simultaneously on a range of new technologies. The aim, as always, is to create more motoring enjoyment using less energy.

TEXT: *Johannes Winterhagen* — PHOTOGRAPHY: *Hartmut Nägele*

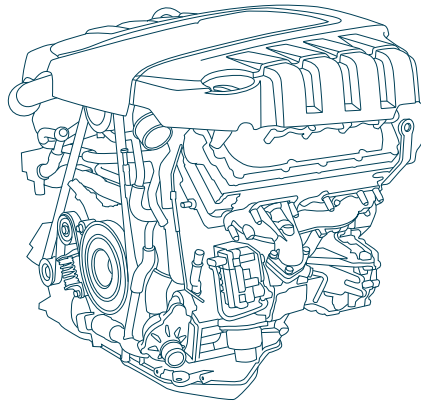

## *TDI engine*

*A model of efficiency: state-of-the-art diesel engines such as the Audi 4.2-liter V8-TDI combine smooth running, exceptional torque and low fuel consumption.*

*When the Golf*<sup>1</sup> first appeared in 1974, customers had a choice between two types of petrol engine. A three-gear automatic gearbox was available on request for the more powerful 70 PS engine (51 kW). Today's Golf customer has many more options to choose from. Engine output ranges from 63 kW to 221 kW (85 – 300 PS) for petrol engines and from 81 kW to 135 kW (110 – 184 PS) for diesel ones. In addition, there is a particularly economical gas-powered variant with an output of 81 kW (110 PS). A direct-shift gearbox takes care of gear changing. It handles this without any loss of traction, so smoothly and quickly that usually the driver can only detect the change by checking the tachometer. A plug-in hybrid and an electric variant have joined the family in 2014, just in time to celebrate the Golf's 40th birthday.

This car – which embodies the Volkswagen brand more than any other – reflects the variety of drive types that will be available in the future. The key to this is the Modular Transverse Toolkit (MQB) – a uniform vehicle architecture used for many models across the Group's different brands, in which the engine is mounted in a transverse arrangement.

Looking across the whole Volkswagen Group, the diversity of drive types is even greater, ranging from the small two-cylinder engines developed by Ducati for its motor cycles right up to Scania's V8 truck engines, where a single cylinder has a capacity of more than two liters. The drive types are as diverse as the vehicle concepts. And yet, when you listen to engine developers talking, they all share the same top priority – efficiency: how can the energy stored in the fuel best be used to create forward movement?

The automobile industry is investing a great deal of knowledge and money in a bid to answer this question – because for the foreseeable future the combustion engine will remain the most important drive type. According to consultants McKinsey, 90 percent of all new cars will still be powered exclusively by combustion engines even in 2020. The proportion of commercial vehicles will be even higher. Petrol

engines, mostly with three or four cylinders, are the first choice for many people across the world when they buy a car. So in addition to the new Golf, Volkswagen has launched a new Modular Petrol Engine System which will be used in many Group models in the future. Higher production numbers mean that costly fuel-saving technologies, such as direct-injection petrol engines or exhaust-driven turbo charging, can be produced even more economically. The particularly environmentally friendly gas-powered TGI models are also based on petrol engines. In comparable driving conditions, they emit 25 percent less carbon dioxide because gas contains less carbon for the same energy content.

From the very beginning, the diesel engine has been regarded as the most efficient engine of all. "This will continue to be the case in the future", explains Ulrich Weiß. Having trained as a mechanical engineer, he develops six- and eight-cylinder TDI engines at the Audi plant in Neckarsulm for premium vehicles such as the Audi A8<sup>2</sup>. Customers who buy these cars expect the ultimate in smooth driving and exceptional torque, but at the same time the lowest possible fuel consumption and minimal emissions. That's a real challenge for developers, because as Weiß points out, "in terms of the physics, these aims are incompatible."

Weiß and his team have achieved the seemingly impossible. Right from the early stages of developing new engines, they look at the most effective ways to clean up emissions. Audi engines, for example, inject minuscule droplets (one cubic millimeter) of diesel fuel at up to 2,500 times air pressure into the cylinder. This results in finer fuel atomization and cleaner combustion. The remaining exhaust particles, which are subject to legal limits, are removed by the exhaust cleaning system. What is special about the Audi system is the combination of two catalytic converters and a particle filter in a single compact unit which can be installed near the engine, where the high temperatures mean it can work extremely effectively.

*“Our top priority is  
to make combustion  
engines even  
more economical.”*

*Ulrich Weiß develops diesel engines  
at Audi's facility in Neckarsulm.*





*“With electric and hybrid drives, we have entered new technological territory. Exciting times for us engineers!”*

—  
*Hanno Jelden develops electric drives for Volkswagen.*

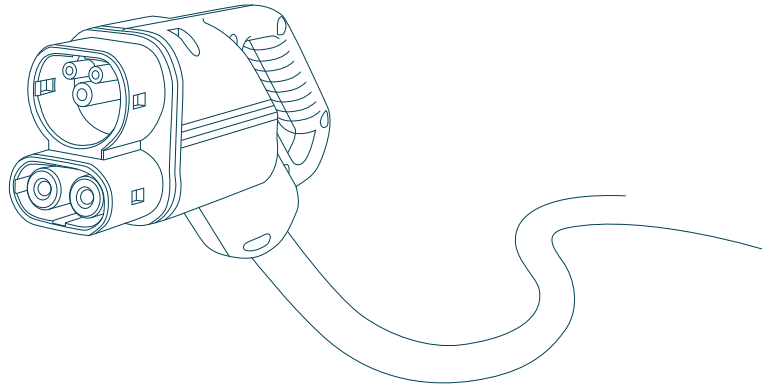

## The dual plug

*The Combined Charging System can be connected both to AC chargers at home or at work and to DC fast charging stations.*

Diesel is the top choice for long-distance drivers – particularly in Europe, where nearly every second new car has a diesel engine. But in China and the United States, the biggest auto markets in the world, the number of diesel cars sold is much lower. Weiß intends to change that. “We are already seeing a noticeable increase in customer acceptance in the USA.” And in China, too, the first Volkswagen and Audi diesel models are already out on the road.

In Asia and also in the USA, hybrid drives in which the regular petrol engine is enhanced by an electric motor play an important role. It’s a fascinating principle, one which Volkswagen researchers had already been working on for many years when Hanno Jelden took over responsibility for all electric drive components. His task was to develop vehicles with hybrid and electric drives ready for series production. The first was the Volkswagen Touareg Hybrid<sup>3</sup>, followed by Audi and Porsche vehicles. “In the course of this project, we learned how to optimize the interaction between the two engines and the transmission. Today’s driver doesn’t even notice the gears changing or the shifts between the combustion engine and the electric motor”, is how Jelden sums the work up.

Depending on their design, hybrid vehicles use between 15 and 25 percent less fuel. “That wasn’t enough for us”, says Jelden. Parallel to the development of series models, he tested a variety of alternative solutions. Plug-in hybrids, whose batteries can also be charged through normal electric sockets, are of particular interest. If the battery is large enough, the electric motor can be designed to deliver strong performance and the plug-in hybrid can travel up to 50 kilometers on electricity alone. According to a study by the Fraunhofer Institute, the average German driver travels only 42 kilometers a day. This means that a plug-in hybrid frequently runs on electricity alone during everyday use, but can also travel longer distances at any time, thanks to its combustion engine. “This kind of car also delivers very dynamic driving”, explains Jelden. “Because when you need it, say when you’re overtaking, you can access the power of both engines.” The combination of efficiency and dynamic driving offered by a plug-in hybrid

will be a feature of many Volkswagen Group models in the future. The Porsche Panamera S E-Hybrid<sup>4</sup> was the first, in summer 2013, and the technology will also be available for the Golf approximately one year later.

Because their range is still limited, pure-play electric cars running on lithium-ion batteries will be found primarily in cities in the foreseeable future. It’s no surprise, then, that Volkswagen’s first electric car is the e-up!<sup>5</sup> city runabout. Consuming only 11.7 kWh per 100 kilometers, it is the most efficient electric vehicle in the world. That’s not an end in itself, explains Jelden. “The e-up!’s low energy consumption means it can travel for around 160 kilometers before the battery needs recharging.” To keep energy requirements as low as possible, Volkswagen’s engineers examined every last detail – from the tires right through to the engine cooling system – looking for unnecessary power-eating elements and finding effective solutions. This enabled them to design a lightweight battery for the e-up! at an attractive price.

When you travel light, you travel further – this also holds true for the Volkswagen XL1<sup>6</sup>, the world’s first one-liter car. Holger Bock, who has been in charge of the project for many years, calls it “a road test for new technologies”. Take the monocoque made of carbon fibers (CFK), for example – a body-in-white which is manufactured in one piece and weighs only 90 kilograms. Comparable bodywork made of steel would weigh more than twice as much. “We save a lot of time compared with the previous assembly process because we no longer need to stick the individual parts together”, explains Bock. The specially designed large-scale machine tool on which the bodywork is formed by “baking” together individual carbon fiber mats over a period of two hours, is a world first. “We will be able to use the knowledge we have gained in other series in the future.” The same applies true for the drop-shaped aerodynamic design of the XL1, the external mirrors which have been replaced by cameras (e-mirrors), and the combined diesel-hybrid drive (see image on page 24/25 for technical details). What do engineers Bock, Jelden and Weiß have in common? They keep pushing forward into new territory – and they are three of the more than 40,000 people developing new vehicles and

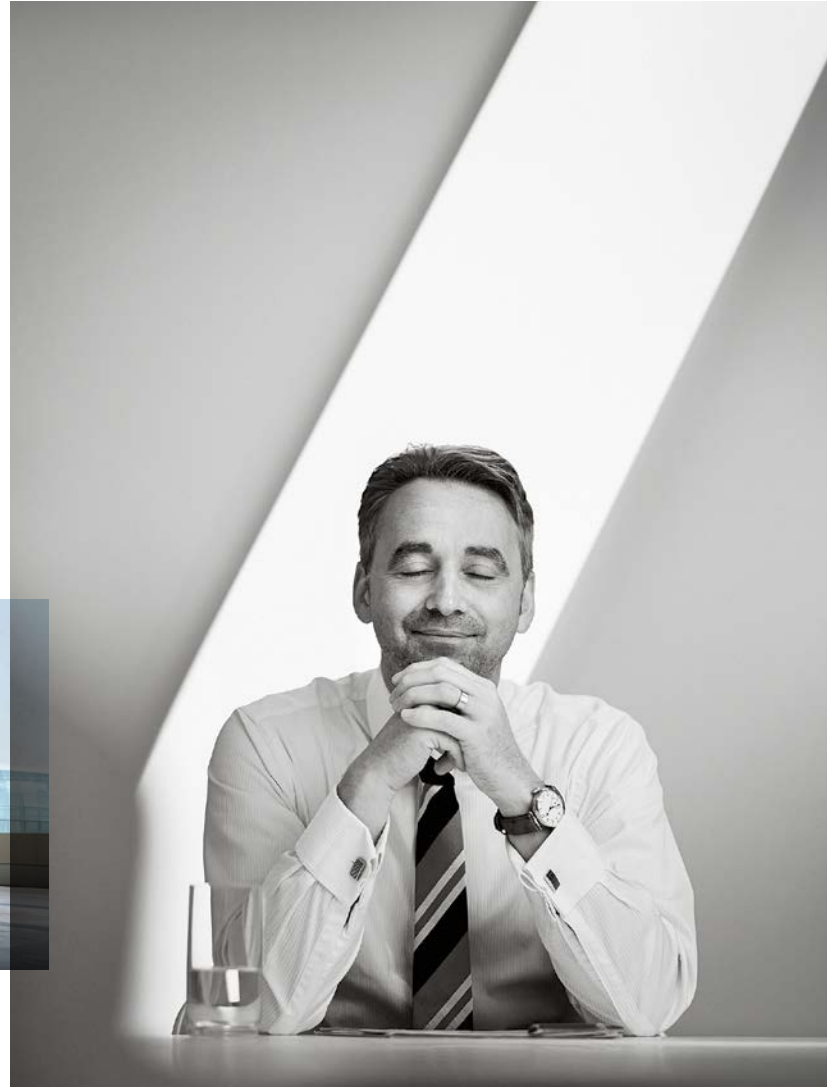

*“Efficiency isn’t just about the  
drive technology – it also  
means working on every detail  
of the vehicle.”*

---

*Holger Bock was project manager for the XL1 and is responsible for the up! and the Polo, among other things, in his role as general vehicle project manager.*

# “Innovative services are becoming more and more important.”

How Volkswagen Financial Services supports new mobility concepts.

## Why is Volkswagen Financial Services getting involved with new mobility concepts?

Our brief is clear: to support sales by the Volkswagen Group brands and to increase customer loyalty. For example, when brands bring out vehicles with alternative drives, it's our job to help them succeed in the market by offering new types of products and services.

## What role does e-mobility play in that?

E-mobility is a good example for how the portfolio of an automotive financial services provider is developing and changing. Take our Blue Power contracts for green electricity, for instance. We can offer these to customers buying electric vehicles who want to run them on renewable energy.

## What role will car sharing play in the future?

Many car sharing schemes are still operating at a loss. One exception is Greenwheels in the Netherlands, which has approximately 2,000 vehicles. That's why Volkswagen Financial Services invested in the company in 2013. This gives us the opportunity to find out more about sustainable customer requirements, just as we do in our own car sharing pilot project, Quicar, in Hanover.

## Can concepts like these be translated into overseas markets?

There is a very strong desire, particularly in Asia, to make sure that the mobility boom is sustainable right from the start. This is why we established Volkswagen New Mobility Services in China. That will help us take advantage of the opportunities we see along the automobile value chain, particularly in the megacities.

technologies in the Volkswagen Group. However, future-proof mobility concepts require more than just the creativity of electrical and mechanical engineers. An electric car is only climate-neutral when it uses renewable energy, for example. Volkswagen Financial Services can arrange a suitable contract for this if required. And every customer who opts for an e-up! and at some time decides to drive off on vacation can hire a more spacious combustion-engine car for up to 30 days a year, free of charge, from Euromobil, the car-hire business owned by Volkswagen Financial Services.

The road to mobility in the future is long, with many forks. Despite all the market research, it is still impossible to predict how soon alternative drive concepts will achieve a breakthrough with customers. The most important thing is to be ready for the change. In every respect. And that's why the new Golf, which for the first time is based on the Modular Transverse Toolkit (MQB), can be delivered with any drive type requested by the customer. Petrol, diesel, gas-powered and electric drive models are all produced on the same assembly line. This makes economic sense, both for Volkswagen and for customers – because fuel-saving drivetrains only help to protect the environment if they are out on the roads.

- 1 Volkswagen Golf fuel consumption in l/100 km combined from 5.2 to 3.2; CO<sub>2</sub> emissions in g/km combined from 122 to 85.
- 2 Audi A8 fuel consumption in l/100 km combined from 9.1 to 5.9; CO<sub>2</sub> emissions in g/km combined from 213 to 144.
- 3 Volkswagen Touareg Hybrid 245 kW fuel consumption in l/100 km urban 8.7 / extra-urban 7.9 / combined 8.2; CO<sub>2</sub> emissions in g/km combined 193.
- 4 Porsche Panamera S E-Hybrid 306 kW fuel consumption in l/100 km combined 3.1; energy consumption in kWh/100 km combined 16.2; CO<sub>2</sub> emissions in g/km combined 71.
- 5 Volkswagen e-up! 60 kW energy consumption in kWh/100 km combined 11.7; CO<sub>2</sub> emissions in g/km combined 0.
- 6 Volkswagen XL1 fuel consumption in l/100 km combined 0.9; energy consumption in kWh/100 km combined 7.2; CO<sub>2</sub> emissions in g/km combined 21.  
Audi A3 Sportback fuel consumption in l/100 km combined from 6.5 to 3.3; CO<sub>2</sub> emissions in g/km combined from 149 to 88 (see figure page 19).  
Volkswagen e-Golf 85 kW energy consumption in kWh/100 km combined 12.7; CO<sub>2</sub> emissions in g/km combined 0 (see figure page 20).

Nadja Lucchini-Kranz,  
Head of International  
Marketing and Innovations,  
Volkswagen Financial  
Services AG



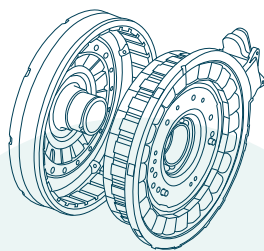

XL1

# Electric motor

(20 kW / 27 PS)

140 Nm

Up to  
50 km  
range purely on  
electricity, with  
zero emissions

## VOLKSWAGEN XL1

*Volkswagen is pushing the boundaries of what is technically achievable: efficient diesel hybrid drive, minimal weight, aerodynamic perfection – making 0.9 liters average fuel consumption a reality.*

### HIGH-VOLTAGE BATTERY

*Lithium-ion battery with 5.5 kWh capacity.*

### LIGHTWEIGHT BODY CONSTRUCTION

*Thanks to the carbon-fiber monocoque, which includes wing doors and a laminated glass windscreen, the body weighs only 230 kilograms.*

### LOW-ROLLING RESISTANCE TIRES

*The tires work in conjunction with the extremely aerodynamic bodywork (Cd of 0.189) to achieve even greater energy efficiency.*

### MAGNESIUM FORGED WHEELS

*High-tech lightweight construction: so light that they can be lifted with only one hand.*

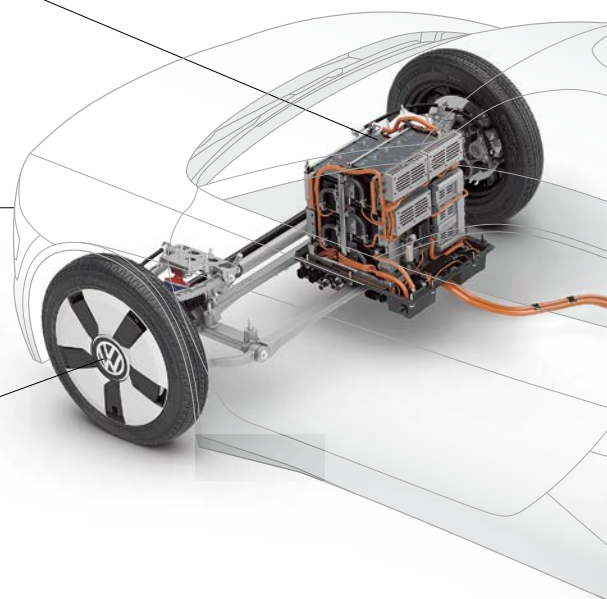



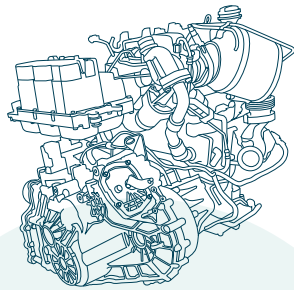

XL1

# Two-cylinder

TDI engine  
(35 kW / 48 PS)

7-speed

direct shift  
gearbox (DSG)

## TWO-CYLINDER TDI

*The efficient lightweight diesel engine working in conjunction with the electric motor emits a mere 21 g/km of CO<sub>2</sub>.*

## CERAMIC BRAKES

*Gripping: the XL1's braking system features include fast response, rapid cooling, minimal weight and resistance to corrosion.*

795 kg

– what the most economical series car in the world weighs.

## TITANIUM EXHAUST SYSTEM

*Titanium – the material of the future: very light and strong, withstands temperature differences and corrosion.*

## ELECTRIC MOTOR

*The XL1 uses less than 0.1 kWh per kilometer when in electric mode.*

## DSG LIGHTWEIGHT TRANSMISSION

*7-speed direct shift gearbox, developed by Volkswagen.*

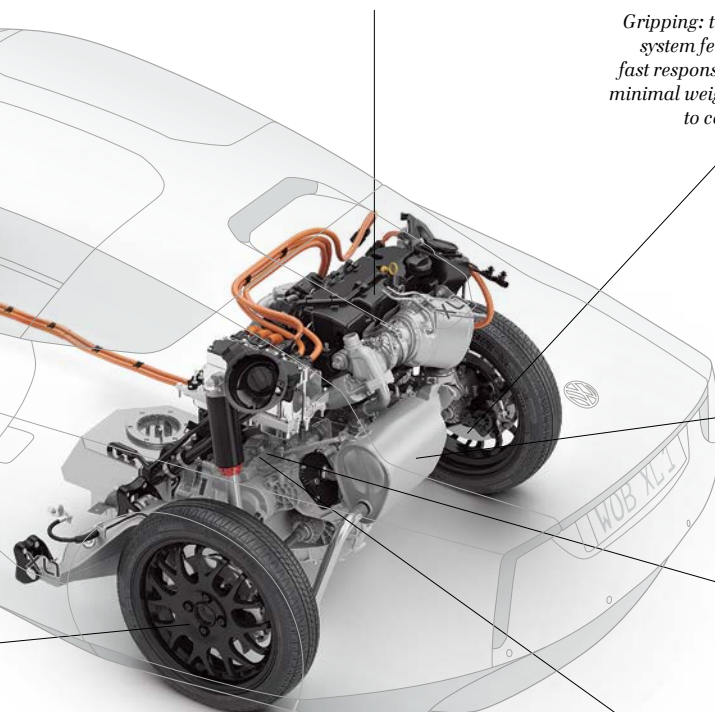





# *Act*

—  
2

---

Shaping the future means having the courage and strength to act. Volkswagen aims to be the world's number one automobile manufacturer, both economically and ecologically, by 2018. Our wealth of ideas and our ability to innovate are the fuel to help us achieve this ambitious goal.

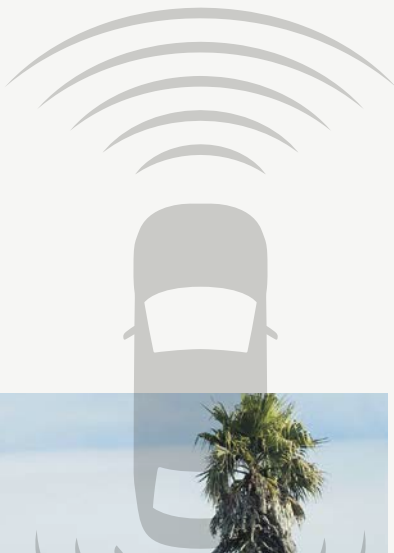

# Smart driving

In the not-too-distant future, Audi will be able to offer vehicles that can maneuver through traffic congestion and even navigate tight spaces in parking lots – without any intervention from the driver. “Vorsprung durch Technik” – that’s what it’s all about. That is also why Audi is conducting research into piloted driving in Silicon Valley in the trickiest place of all – in congested city traffic.

TEXT: Jens Meiners — PHOTOGRAPHY: Matthias Haslauer





City traffic poses the greatest technical challenge  
for modern driver assistance systems.



*A light load: today, the hardware required for the vast amount of computing power that makes piloted driving possible is no bigger than a laptop. In addition, a new type of architecture is paving the way for automated driving: its “intelligence” resides in a central driver assistance control unit (zFAS) about the size of an iPad.*

# Piloted driving

*The vision of driverless driving has already become reality in a research vehicle based on the A7 Sportback<sup>1</sup>.*

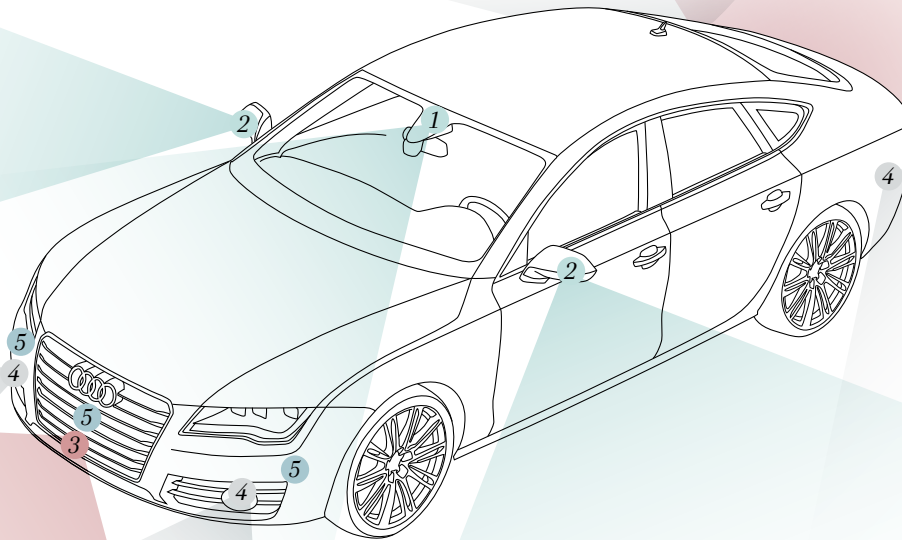

1

#### FRONT CAMERA

records images in black and white and color. This is the heart of the sensor technology behind piloted driving. It detects traffic lights and signs, for example.

2

#### TOP-VIEW CAMERA

generates a view of the area around the vehicle from the images recorded by cameras in the radiator grill and the side and rear mirrors.

3

#### LASER SCANNERS

monitor the road in front and behind, identify stationary and moving objects and help with lane changing.

4

#### RADAR SENSORS

at the front maintain a constant distance from crossing traffic and vehicles cutting in. They are also able to “see” in fog. At the back, they support assisted lane changing and blind spot recognition.

5

#### ULTRASOUND SENSORS

are located at the front, rear and sides of the vehicle. They provide the all-round visibility needed for piloted parking.

*With his hands firmly on the wheel,* Jörg Schlinkheider turns into Twin Dolphin Drive in Belmont, California. Suddenly, the screen in the center console signals: the car can take over now. Schlinkheider and his team are conducting research for Audi into the driver assistance systems of the future at Audi’s own Electronics Research Laboratory (ERL). He presses two buttons on the lower spokes of the steering wheel. The A7 Sportback prototype is now driving “by itself” – the driver can lean back and relax. The steering wheel automatically slides forward out of the way, the three-liter compressor starts accelerating and the vehicle stays perfectly in lane. The saloon brakes gently at red lights and before any objects in its way, and comes to a stop in good time.

Meanwhile, the driver has time to do other things: the central screen offers telephone and text messaging functions. Surfing the Internet is another possibility. Very soon it will be possible to access video-conferencing in this vehicle.

Welcome to the vision of piloted driving, which in this Audi research vehicle has already become reality. Initially the self-driving A7 Sportback gives no indication of its extraordinary capabilities. The additional cameras, radar and ultrasound sensors, and the laser scanners are completely hidden. All sensors are perfectly integrated into the vehicle and are barely visible. And yet numerous electronic eyes and sensors are constantly scanning the vehicle’s surroundings. The data they gather is consolidated and compared in real time in a central processor. The developers’ aim is to replace today’s GPS navigation systems, which rely on data relayed by satellite – in the future, this sensor data will be all that is needed. It will enable the vehicle to make its own way to the destination and to carry out all maneuvers on autopilot, although the driver always remains fully responsible.

Testing the vehicle in this environment shows how far advanced Audi’s piloted driving system already is. Gone are the days of testing the prototypes only on the highway and country roads – now they are also



## *The car that “drives itself” – the driver can relax.*

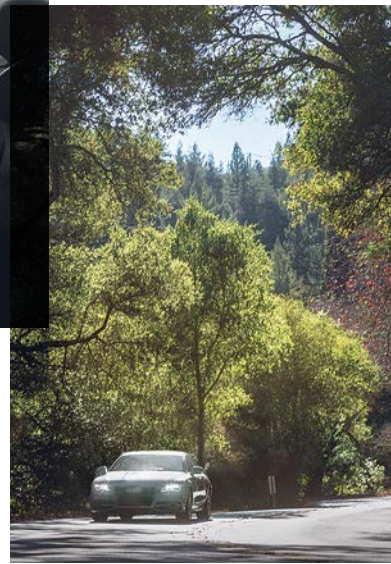

*A7 Sportback: the Audi research vehicle  
has covered a lot of miles.*

out in heavy city traffic. “The city environment is the biggest technical challenge of all”, says Schlinkheider. In the search for a solution, he also maintains contact with experts from the IT industry and creative start-up companies in Silicon Valley.

“Piloted driving is on the way to becoming a core competency for Audi”, explains Thomas Müller, who is responsible for the whole project at Audi in Ingolstadt. “We use this term deliberately because we believe that, in the future, people will still want to drive their vehicle themselves in many situations.” At the same time, driver assistance should make the job easier whenever that makes sense. Not just maneuvering in tight parking spaces or in parking lots, but also in slow-moving traffic on the highway. Müller predicts that these revolutionary functions could be incorporated into series production before the end of the decade. However, for piloted driving to become reality, the essential non-technical conditions also need to be agreed through working with governments and insurance companies.

That is why it will be some years yet before a series model vehicle manages to make its way through dense inner city traffic completely autonomously. That challenge spurs Audi developers on to research these applications even more intensively. “We keep on learning all the time”, says Schlinkheider. “That’s the only way we will achieve things that seem impossible today.”

At the moment, there are only a few public roads in California where the prototype is tested. When the A7 Sportback nears the end of the test stretch, the steering wheel slides back to its original position. A warning tone alerts Jörg Schlinkheider to take over the controls. This will happen less often in the future, and the day will come when the Audi prototypes will be out piloting across the whole of California.

<sup>1</sup> Audi A7 Sportback fuel consumption in l/100 km combined from 8.2 to 5.1; CO<sub>2</sub> emissions in g/km combined from 190 to 135.

# 大众长春

(“Volkswagen Changchun” in Chinese)

## *Future factory*

The city of Changchun is one of the powerhouses of the motor industry in China. This is where China’s automotive future begins – and in the new Volkswagen FAW Engine plant, where highly efficient, low-emission, four-cylinder engines roll off the production line. The factory was designed following the criteria of the “Think Blue. Factory.” sustainability program.

TEXT: *Christiane Kühn* — PHOTOGRAPHY: *Andreas Mader*





# 发展战略

(“Development strategy” in Chinese)

*Between now and 2018, Volkswagen and its partners plan to invest over 18 billion euros in the future of their German-Chinese success story.*



*Wearing white gloves, Liu Shicai holds* a vernier caliper against the positioning sleeve of a nearly finished engine. Its depth measures 6.73 millimeters. Exactly right. The flywheel, part of the clutch, will later be fitted onto the sleeve. “Random tests like these are always the first thing I do in the morning”, says Liu, who is Assembly Team Leader at Volkswagen FAW Engine’s new drivetrain plant in Changchun, a city of several million inhabitants in northeast China. The 27-year-old works in end-of-line-testing. By this point, the engines have already undergone leak and cold tests. Some of them then continue on to what is called the hot test, which simulates starting the engine in the car. Quality without compromise is absolutely central – throughout the whole plant.

“Quality is just as important for us as it is in Germany and we make sure that we have the same high standards like in all other engine plants worldwide”, Horst Kersten Gaudlitz says. He is General Manager of the engine plant in Changchun, which came on stream in August 2013 – one of a total of 17 sites operated by the Group in China today. The Changchun engine plant belongs to a network of vehicle and components plants run as autonomous factories by Volkswagen and its joint venture partner First Automotive Works (FAW).

Some 1,000 1.8 and 2.0 liter petrol engines leave the production plant every day. Their destinations include the large vehicle plant nearby in Changchun, where models such as the Volkswagen Golf<sup>1</sup>, or the Audi A4<sup>2</sup> and Audi Q3<sup>3</sup> are manufactured. The new powertrain factory provides additional production capacity for up to 450,000 engines a year. “We need this extra capacity because demand for mobility in China is booming”, Gaudlitz comments. Between now and 2018, FAW-Volkswagen and another joint venture company, Shanghai-Volkswagen, plan to invest over €18 billion in the future of their German-Chinese success story. Manufacturing capacity at the Group’s plants in China will by then have been extended to four million vehicles a year.

General Manager Gaudlitz knows that state-of-the-art components production facilities are essential for achieving this: “Up to 80 percent of the components in our engines are made in China.” The plant makes its own crankshafts, cylinder heads, cylinder blocks and connecting rods. The company orders blanks for these, as well as other pre-products, from some 150 suppliers in the People’s Republic.



*Checking and testing are part of the daily routine in the new Volkswagen FAW Engine plant – for example in the hot test room.*

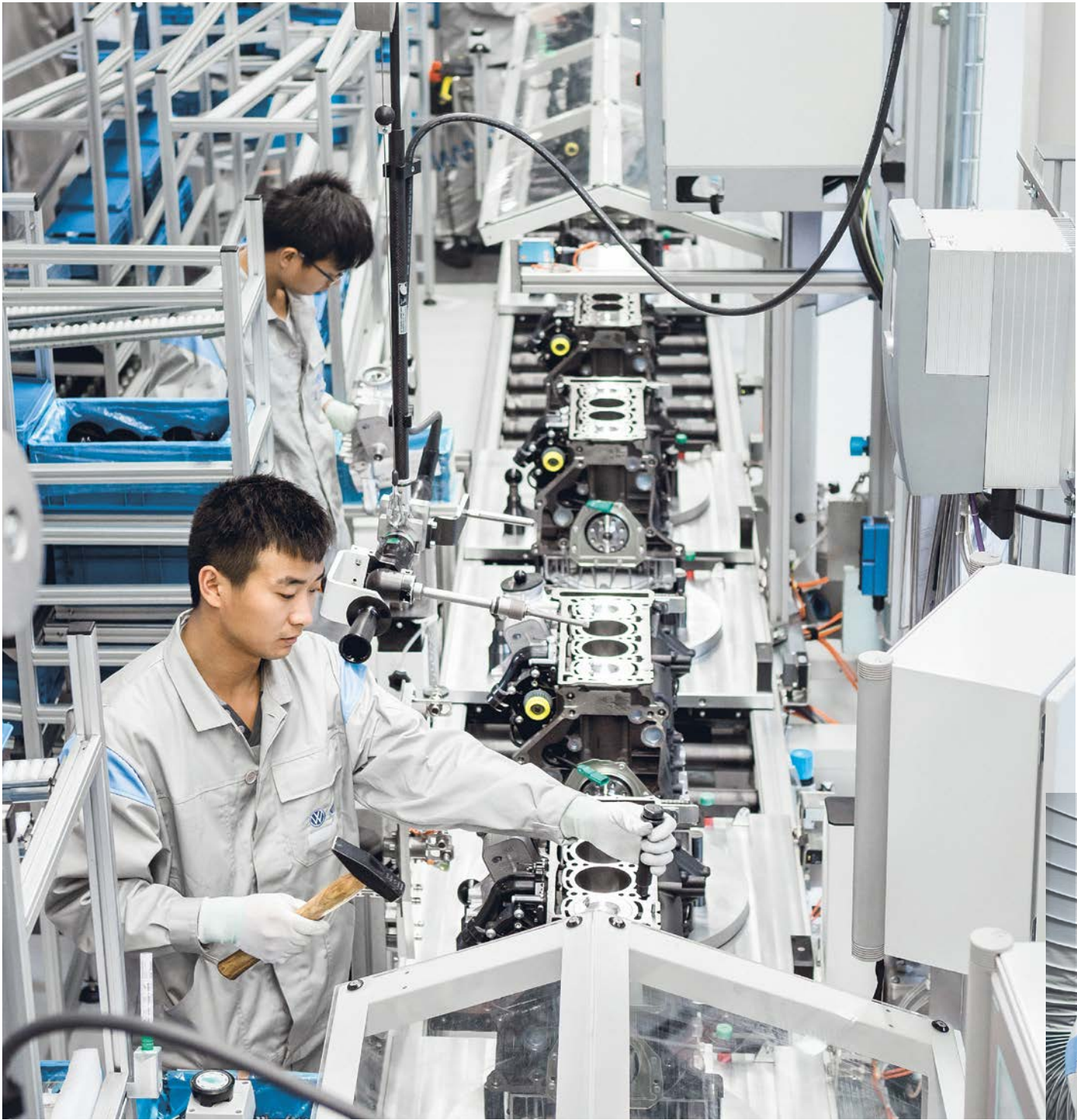

*Manufacturing for the local market: the new Changchun plant will give Volkswagen additional capacity to produce 450,000 engines in China by mid-2014.*

# 责任

(“Responsibility” in Chinese).



Ensuring that all products and production processes are environmentally friendly is another item at the top of the General Manager’s agenda. The Chinese government has launched an ambitious program to improve air quality. Volkswagen’s production processes for state-of-the-art powertrains in Changchun are even more advanced. The plant is already equipped to produce engines, which meet the tough Euro 6 European emissions standard.

In Changchun, sustainable production processes are top priority. “We built our factory based on the criteria of the ‘Think Blue. Factory.’ program”, Gaudlitz says. Through this program, Volkswagen intends to make its manufacturing 25 percent more environmentally friendly worldwide by 2018, as well as becoming the most sustainable automobile manufacturer in China. “As early as the planning stage for the buildings, we took great care to use technologies that conserve resources.” For example, waste heat from production processes is recaptured using heat exchangers, and rain water is collected and recycled. The winter sun coming through the large number of ceiling windows bathes the factory interior in soft daylight. This saves energy. Horst Kersten Gaudlitz points upwards: “We’ve coated all the ceiling pipes in a pale color to ensure the light is reflected. And it goes without saying that we only use energy-saving lamps.” A solar power system on the roof supplies the production facilities with electricity for lighting and ventilation. Waste packaging and metal waste are sent to recycling companies. An overhead electric monorail conveyor transports the engines from the assembly line to the storage depot. “That is cleaner and more efficient than using lift trucks”, explains Gaudlitz.

In terms of both quality and sustainability, Horst Kersten Gaudlitz and his team at the Changchun engine plant have taken on ambitious challenges for the future. Team leader Liu Shicai, who looks after employee training in addition to addressing quality issues, puts it succinctly: “We are all really keen to learn here. That way we’ll improve bit by bit every day.”

- 1 Volkswagen Golf fuel consumption in l/100 km combined from 5.2 to 3.2; CO<sub>2</sub> emissions in g/km combined from 122 to 85.
- 2 Audi A4 fuel consumption in l/100 km combined from 8.4 to 4.2; CO<sub>2</sub> emissions in g/km combined from 197 to 109.
- 3 Audi Q3 fuel consumption in l/100 km combined from 7.7 to 5.2; CO<sub>2</sub> emissions in g/km combined from 179 to 137.

# *Less is more*

The Porsche Panamera S E-Hybrid<sup>1</sup> represents an entire generation of new vehicles in the Volkswagen Group, combining all the advantages of an electric motor with the performance of a sports car. We put through its paces on a test drive in Leipzig.

TEXT: Johannes Winterhagen — PHOTOGRAPHY: Andreas Mader

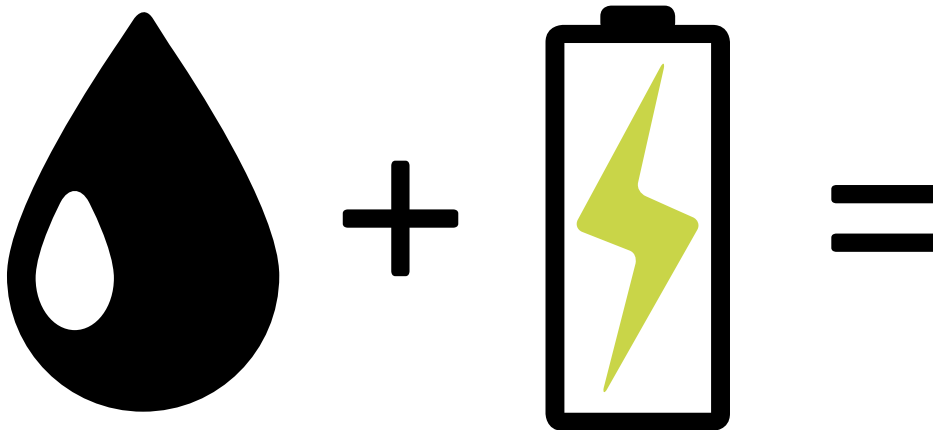





## 6.1 km

*Out on a country road. A conventional hybrid vehicle would be switching to its combustion engine by now, if not before. But the Panamera S E-Hybrid's lithium-ion battery is not even half empty. We continue driving exclusively on electric power.*



Start —

## 0.2 km

*The Panamera S E-Hybrid leaves the Porsche plant on the outskirts of Leipzig with the battery fully charged. The electric motor is the sole power source moving us forward, as long as we don't press the accelerator pedal below the pressure point.*



## 12.8 km

*We have reached Leipzig's historic old town without using the combustion engine. The Panamera S E-Hybrid takes a short break in front of the New Town Hall.*



## 24.4 km

*At the edge of the city, the battery registers empty. No problem – the combustion engine cuts in almost unnoticed and takes over. Shortly afterwards, we switch on the E-Charge mode and recharge the battery, saving energy during the journey.*



## 39.6 km

*Full throttle on the highway – the combustion engine and the electric motor are now working together. We allow ourselves some fun and move out into the fast lane.*



*It all began with the idea* of bringing together the seemingly impossible in a single vehicle: the out-and-out sportiness of a Porsche, the long-distance touring comfort of a sedan and the fuel consumption of a small car. Years of intensive development work followed, until the automobile finally came into being in summer 2013. The Porsche Panamera S E-Hybrid delivers a peak output of 306 kW (416 PS), with fuel consumption of only 3.1 liters over 100 km in the standard driving cycle.

The man who turned this idea into a model ready for series production is Dr. Gernot Döllner. The powertrain that makes the seemingly impossible possible is the plug-in hybrid. It combines the quiet, emis-

sion-free driving experience of an electric vehicle with a combustion engine's long-distance touring capability. The Panamera S E-Hybrid features a lithium-ion battery that can be refueled through a domestic electric socket. Once the battery has lost its charge, the combustion engine cuts in. "Even we were amazed to see how far fuel consumption drops when these two technologies are used together", says Döllner.

The E-Hybrid is built on the same production line at Porsche's Leipzig plant as all the other series variants. Döllner is a regular visitor. During our test drive through the capital city of Saxony, he explains the car's different types of operation. It always starts in electric mode. The E-Hybrid solely uses the power of the electric motor until it

## 60.1 km

*That's enough for today. Back to the electric socket. Fully recharging the battery takes a good four hours. Every Panamera S E-Hybrid customer receives a complimentary charging station.*



— *Finish*



## 52.5 km

*Back at the factory, we do a few rounds on the Porsche test track. Just like every Porsche, the Panamera S E-Hybrid possesses all the essential features of a racing car. "It also corners sideways", says Gernot Döllner, the engineer responsible for the series.*

reaches 135 km/h. The car only shifts into hybrid mode once the battery starts to run low or when the driver presses the accelerator beyond a defined pressure point. That's when the combustion engine takes over. When the E-Hybrid brakes, the electric motor runs in the opposite direction and recharges the battery. The electric motor provides additional power for acceleration, saving fuel. To recharge the battery during the journey, the driver switches to E-Charge mode – this makes sense, for example, when you want to start using the electric motor again when you arrive in a residential area. As with every Porsche, the driver can also press the Sport button; the Panamera S E-Hybrid reaches its maximum output when the combustion engine and the electric motor work in tandem.

"The E-Hybrid is a truly groundbreaking achievement", says Döllner. And as he points out, this is not just his view. Plug-in hybrids will play a crucial role in future in the Volkswagen Group's brands.

1 Porsche Panamera S E-Hybrid 306 kW fuel consumption in l/100 km combined 3.1; energy consumption in kWh/100 km combined 16.2; CO<sub>2</sub> emissions in g/km combined 71.

HOW A PLUG-IN HYBRID WORKS

The Porsche Panamera S E-Hybrid is a plug-in hybrid. This differs from other hybrid drivetrains in that the battery can be charged through a socket, like in an electric car.

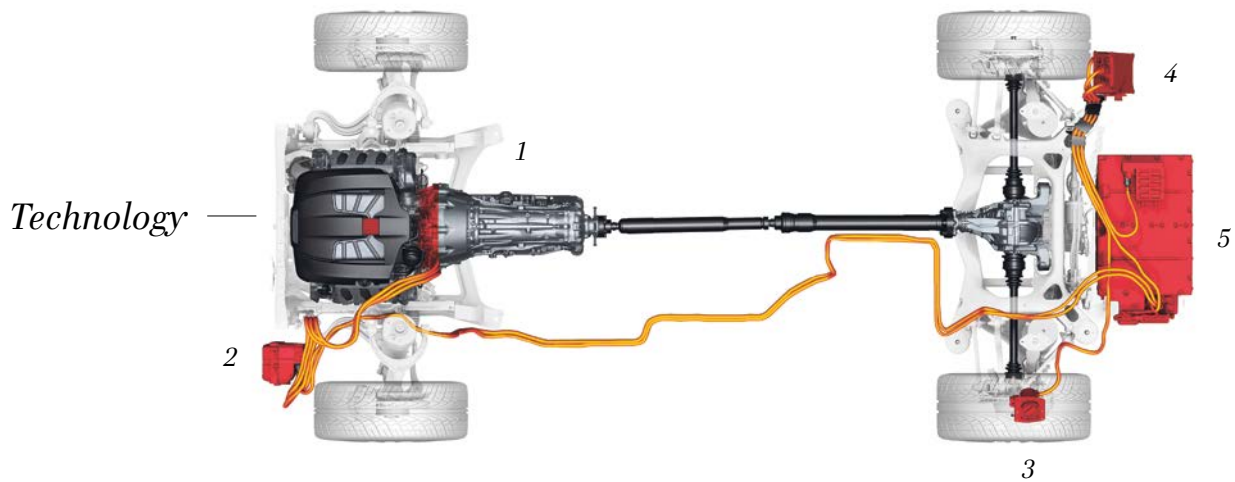

1

**POWER SOURCE**

The electric motor sits between the combustion engine and the transmission. If the engine is not needed, it can be disengaged and switched off.

2

**CURRENT TRANSFORMER**

Power electronics transform the direct current from the battery into the alternating current needed by the electric motor.

3

**RECUPERATION**

Rather than being lost, a large part of the brake energy is converted back into electrical energy.

4

**ZERO EMISSIONS**

A plug-in hybrid is charged using a cable. The car has zero CO<sub>2</sub> emissions in electric mode if recharged with power generated from renewable sources only.

5

**ENERGY SOURCE**

Thanks to a modern lithium-ion battery, a Panamera S E-Hybrid can travel up to 35 km in electric mode, depending on weather and driving style.

# Climate zones

It's their job to be out on the road, no matter how demanding conditions are: in the icy cold in Sweden, through heavy rain in Brazil, over mountainous terrain in Turkey. Haulage companies across the world put their trust in the reliability and efficiency of the Volkswagen Group's commercial vehicles. We meet three people out on the road.

TEXT: Tina Rumpelt — PHOTOGRAPHY: Göran Wink, Marcos Camargo, Matthias Haslauer





*-16 °C*

*Icy northeast wind  
Central Sweden*

*Heavy loads and difficult terrain are no problem at all for Andre Sjölander, a fourth-generation timber transporter in Näsåker, central Sweden. His Scania R 730 8x4 has 537 kW (730 PS) behind it, enabling the four-axle truck from Södertälje to pull a total vehicle weight of up to 74 tonnes. “It can cope with any terrain”, says company owner Sjölander with some pride. And it’s really environmentally friendly – the powerful 16-liter V8 engine runs on biodiesel.*

+ 21 °C  
—  
*Rainy season*  
—  
*Central Brazil*

*Rogério Oliveira de Santana is passionate about truck driving. The 30-year-old clocks up around 200,000 kilometers a year. His MAN TGX 29.440 6x4 can pull up to 80 tonnes. The summers in Central Brazil are hot and in winter there are heavy rains. Oliveira de Santana knows he can rely on his 324 kW (440 PS) tractor unit with two driven axles, “especially when the asphalt surface runs out and the rain has turned the dirt roads to mud”.*







+15 °C  
Spring  
Turkey's  
Mediterranean coast

*Şaban Ürkmez calls his business in Antalya “The Little Bus Service”. When he is behind the wheel, he prefers to drive the Volkswagen Crafter Minibus<sup>1</sup>. The 13-seater copes just as easily with the stop-start city traffic as the steep, winding country roads in the mountainous hinterland. What’s more, the Crafter is “very comfortable for both the driver and his passengers”, says Mr. Ürkmez.*

*As a business owner, he particularly appreciates the two-liter TDI engine with 120 kW (163 PS), low fuel consumption and low maintenance costs.*



<sup>1</sup> Volkswagen Commercial Vehicles Crafter Kombi fuel consumption in l/100 km combined from 8.3 to 6.3; CO<sub>2</sub> emissions in g/km combined from 218 to 166.



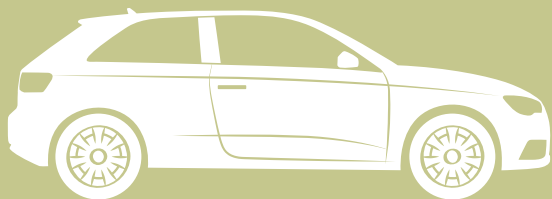

Audi A3 **85** g CO<sub>2</sub>/km (EU5)  
1.6 l, 81 kW, 3.2 l/100 km



SEAT Leon **85** g CO<sub>2</sub>/km (EU5)  
1.6 l, 81 kW, 3.2 l/100 km



Volkswagen e-up! **0** g CO<sub>2</sub>/km  
11.7 kWh/100 km

# Efficiency lineup

Taking responsibility means more than simply complying with legislation. That is why the Volkswagen Group already offers more than 300 model variants today that emit less than 120 grams of CO<sub>2</sub> per kilometer. Over 50 vehicles have even lower emissions, at less than 100 grams. So environmentally friendly mobility is possible in all classes and sizes.<sup>1</sup> Here we show a selection ...

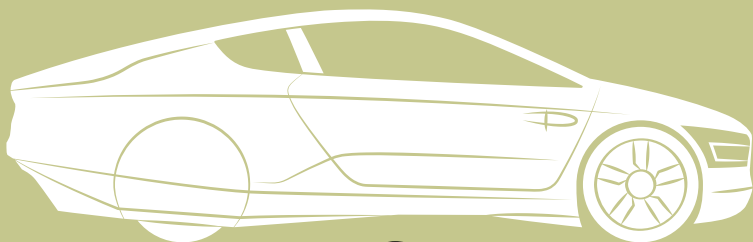

Volkswagen XL1 **21** g CO<sub>2</sub>/km (EU6)  
0.8 l, 51 kW, 0.9 l/100 km



Audi A1 Sportback **99** g CO<sub>2</sub>/km (EU5)  
1.6 l, 66 kW, 3.8 l/100 km



SEAT Ibiza SC **88** g CO<sub>2</sub>/km (EU5)  
1.2 l, 55 kW, 3.4 l/100 km



Audi A3 Sportback **88** g CO<sub>2</sub>/km (EU5)  
1.6 l, 81 kW, 3.3 l/100 km



Volkswagen Polo **87** g CO<sub>2</sub>/km (EU5)  
1.2 l, 55 kW, 3.3 l/100 km



ŠKODA Rapid **99** g CO<sub>2</sub>/km (EU5)  
1.6 l, 66 kW, 3.8 l/100 km



ŠKODA Citigo<sup>2</sup> **79** g CO<sub>2</sub>/km (EU5)  
1.0 l, 50 kW, 2.9 kg/100 km



Audi A1 **99** g CO<sub>2</sub>/km (EU5)  
1.6 l, 66 kW, 3.8 l/100 km



SEAT Ibiza ST **88** g CO<sub>2</sub>/km (EU5)  
1.2 l, 55 kW, 3.4 l/100 km



Audi A3 saloon **99** g CO<sub>2</sub>/km (EU5)  
1.6 l, 77 kW, 3.8 l/100 km



Volkswagen Golf TGI **92** g CO<sub>2</sub>/km (EU5)  
1.4 l, 81 kW, 3.4 kg/100 km



Porsche Panamera S E-Hybrid **71** g CO<sub>2</sub>/km (EU6)  
3.0 l, 306 kW, 3.1 l/100 km



SEAT Mii<sup>2</sup> **79** g CO<sub>2</sub>/km (EU5)  
1.0 l, 50 kW, 2.9 kg/100 km



SEAT Ibiza **88** g CO<sub>2</sub>/km (EU5)  
1.2 l, 55 kW, 3.4 l/100 km



ŠKODA Fabia estate **88** g CO<sub>2</sub>/km (EU5)  
1.2 l, 55 kW, 3.4 l/100 km



Volkswagen Golf **85** g CO<sub>2</sub>/km (EU5)  
1.6 l, 81 kW, 3.2 l/100 km



ŠKODA Fabia **88** g CO<sub>2</sub>/km (EU5)  
1.2 l, 55 kW, 3.4 l/100 km



Volkswagen Jetta Hybrid **95** g CO<sub>2</sub>/km (EU6)  
1.4 l, 125 kW, 4.1 l/100 km



ŠKODA Rapid Spaceback **99** g CO<sub>2</sub>/km (EU5)  
1.6 l, 66 kW, 3.8 l/100 km



ŠKODA Octavia estate **87** g CO<sub>2</sub>/km (EU5)  
1.6 l, 81 kW, 3.3 l/100 km

1 The data for the models shown here are values for combined fuel consumption and CO<sub>2</sub> emissions.  
2 These models are CNG vehicles.

3

# *Experience*

3

---

The automotive future is something we will experience with all our senses. It will be made possible by thrilling technology and fascinating design – and the combined efforts of people in the Volkswagen Group across the world.



---

Pianist Lang Lang talks about his first  
drive in the Volkswagen e-up!, and the special  
experience of silent travel.

**TEXT:** *André Boße* — **PHOTOGRAPHY:** *Matthias Haslauer*





# Shhh...



Is  
the  
engine  
switched  
on?

Oh, we're  
already  
moving!

Sitting  
in a car  
enjoying

almost total  
silence –

it's a unique  
experience.

I travel a lot by car.

If I'm traveling  
within Europe,

I often choose not to fly  
because it's so much  
trouble. This means that,  
after my apartment,

**my car is the place**  
where I spend the  
most time.

I usually listen to music  
in the car –

## lots of classical pieces

of course, but also jazz or even pop music.

I always play music really  
loud – that’s

partly to

drown out the sound of the engine.

It’s different in an electric car.

There’s no engine noise, only a pleasant whoosh,

like a puff of wind. It reminds me more

of riding in a modern elevator than a conventional car.

**It’s a wonderful feeling to be traveling so silently and to be so “green”, too.**

This technology is fascinating – I’m sure it will catch on.

Think about music industry: only ten years ago,

I would never have dreamed of downloading music from

the Internet. And now I find it

## the best and most convenient way

of discovering new music.

Electromobility will develop in the same way:

in a few years’ time we will see

a lot more silent cars like this one on the streets.

Their range will be

much greater

and we won’t

have to go

hunting

## for charging stations.

Electromobility

makes the

world a

quieter

place.

That’s a nice

thought, because

silence is important to

me as a musician.

Without silence, there would

be no music.

Every piece of music

begins in silence, and ends in silence.

I love to immerse myself

## in that moment of absolute calm

before the beginning of a piece.

It’s the only way I can concentrate. I like to call it

**my “pause mode”. As much as I love music in nearly all its forms,**

**if there were no silence,**  
it would not be so precious. When I play a concert, I find intrusive noises very difficult to cope with and yet off stage, there's the sound of machinery and mechanical noises that I really appreciate. Noise always means life, energy, movement. The car is accelerating at the moment. It's so quiet and effortless. I hear the sound of the wheels on the road getting stronger, and I feel the torque kicking in, the car speeding up.

It's an exciting feeling!

Like a crescendo. The music gets louder, but not in a sudden, alarming way; it builds slowly and organically.

**The e-up! sounds gentle –**  
and with its sound  
the landscape appears  
more gentle,  
the green  
of the forests,  
the sunlight.  
I'd like  
to keep  
on  
driving.



—  
*Lang Lang,*  
pianist

# *Learning by doing*

---

Teams of students build their own racing cars.  
That's the idea behind the international Formula Student program.  
In Spain, SEAT is sponsoring the competition, where  
there's more at stake than just being the first to the finishing line.

TEXT: *Marc-Stefan Andres* — PHOTOGRAPHY: *SEAT and Formula Student Spain (Guillem Hernández)*

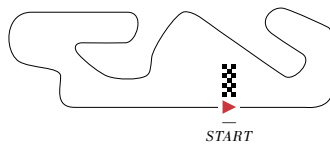



*Subject: performance. Budding engineers demonstrate their creativity and professionalism in the international Formula Student competition.*



▲  
*It's not just about speed: 34 teams present their self-built racing cars on the Circuit de Catalunya near Barcelona.*

*“Formula Student is more exciting than a Formula One race”,* says SEAT’s engineer Miguel Ángel Escudero. He is standing on the Circuit de Catalunya to the north of Barcelona. He is one of 19 SEAT specialists evaluating the performance of the next generation of young technical specialists. A total of 900 budding engineers in 34 teams showcase their self-built racing cars, some of them powered by a combustion engine and others by an electric motor. “The results are really professional”, says Escudero. “We evaluate what the students have achieved not only in terms of engineering and how the car handles, but also as regards their cost accounting and business skills.”

Before the one-seater cars arrived at the race track in the late summer of 2013, they had spent a year in development – planning, drafting, running simulations, building and testing models. “You say goodbye to your private life as soon as you join the team”, says Jan Glenzer, aged 27, who came to Spain with his fellow team members from Esslingen in Germany. “We were often in the workshop from early in the morning till late at night.” Their efforts paid off. The Swabian university students’ racer was placed first overall. Having German teams take part in the Spanish competition is also part of the thinking behind Formula Student. The competitions are held in half a dozen car-loving countries, from the USA to Germany. It’s important that the engineers of tomorrow make international contacts as early as possible.

When they were developing their racing car, the ten students from Rennstall Esslingen took on all the same tasks that confront a car manufacturer with thousands of engineers. Glenzer was responsible for the car’s dynamic handling, among other things. “I modeled the car and ran simulations to work out how we could improve its performance.” He likes the fact that Formula Student encourages working independently and taking responsibility. “I could take the decision to transfer the car to a monocoque chassis. That’s also the design used in Formula One cars.”

Miguel Ángel Escudero confirms this impression. “The students learn to understand the car as a whole here. And that’s exactly what we expect of our future employees”, says the engineer. This is why SEAT deliberately sponsors not just a single team, but the whole competition – even supplying a workshop truck with experienced mechanics ready to help all the teams with technical problems. Through their involvement on the jury, the SEAT engineers get to know the next generation. In some cases, so well that many former Formula Student participants have now found jobs with SEAT or elsewhere in the Volkswagen Group.

▼  
*SEAT sponsors not just a single team, but the whole competition.*



*“The students learn to understand the car as a whole here.”*

◀  
*SEAT engineer Miguel Ángel Escudero,  
jury member at the Formula Student Spain 2013.*

# Simple and clever

It's often the little things that make life better. ŠKODA adds clever little details to make day-to-day driving a bit easier. But what makes an idea worth implementing? Here are five questions and answers.

TEXT: Peter Gaide

## Simply Clever – what is the philosophy behind the ŠKODA slogan?

Simply Clever stands for ideas that have a big impact. ŠKODA aims to amaze its customers with useful touches that are well thought-out. When a customer says “I’m so glad they thought of that!”, we know we’ve got it right.

## What sort of touches?

The ice scraper in the fuel filler cap, for example. That little detail means the ŠKODA driver is always prepared for ice and snow. Or the cell phone holder in the middle console, a secure place to keep the phone. Or the car park ticket clip that is attached directly to the windscreen. Other clever ŠKODA touches are the bag hooks – and the double-sided boot mat: one side is covered with carpet to protect delicate items, the other is rubber, making it much easier to clean after transporting damp or dirty items. The umbrella holder built into the rear door of the Superb<sup>1</sup> is another Simply Clever favorite.

## Who comes up with these ideas?

ŠKODA has a tradition of devising practical solutions. The company encourages all its employees – not just product developers – to be creative. Regular workshops are held to brainstorm new ideas. But customers also have their say. In China, the brand recently launched the Clever Together project, where nearly 50,000 drivers logged into a website to send in their ideas for the car of the future. These included a cordless charging system for cell phones, and heated seats operated remotely by buttons in the key fob.

## It's one thing to have ideas, but how are they put into practice?

We aim to incorporate at least two or three useful ideas in every new ŠKODA model. A Simply Clever team drawn from all areas of the company evaluates the ideas. Every suggestion is tested against some 20 different criteria. Is it original and thought-out? Will it stand up to everyday wear and tear, and is it useful? Can the weight be kept down so that it does not impact fuel consumption and CO<sub>2</sub> emissions? Can it be integrated into several model series and used in many countries worldwide? The original 100 ideas are finally whittled down to two or three that are then included in the development of a new car.

## ŠKODA lives and breathes the principle of Simply Clever in the production process, too – how does that work?

Here's a good example: small parts like screws and nuts are automatically sorted by computer in the ŠKODA plants. This ensures that the right parts are always in the right place ready for use and eliminates the risk of errors. Another idea: we developed a new, reusable plastic container for transporting steering wheels. It weighs 62 kilograms less than its predecessor and can hold 20 percent more. Using these new containers, one truck can carry nearly 800 more steering wheels. That's efficient and kind to the environment.

<sup>1</sup> ŠKODA Superb fuel consumption in l/100 km combined from 9.4 to 4.2; CO<sub>2</sub> emissions in g/km combined from 217 to 109.

ŠKODA Octavia fuel consumption in l/100 km combined from 6.7 to 3.2; CO<sub>2</sub> emissions in g/km combined from 156 to 85 (see figure below).





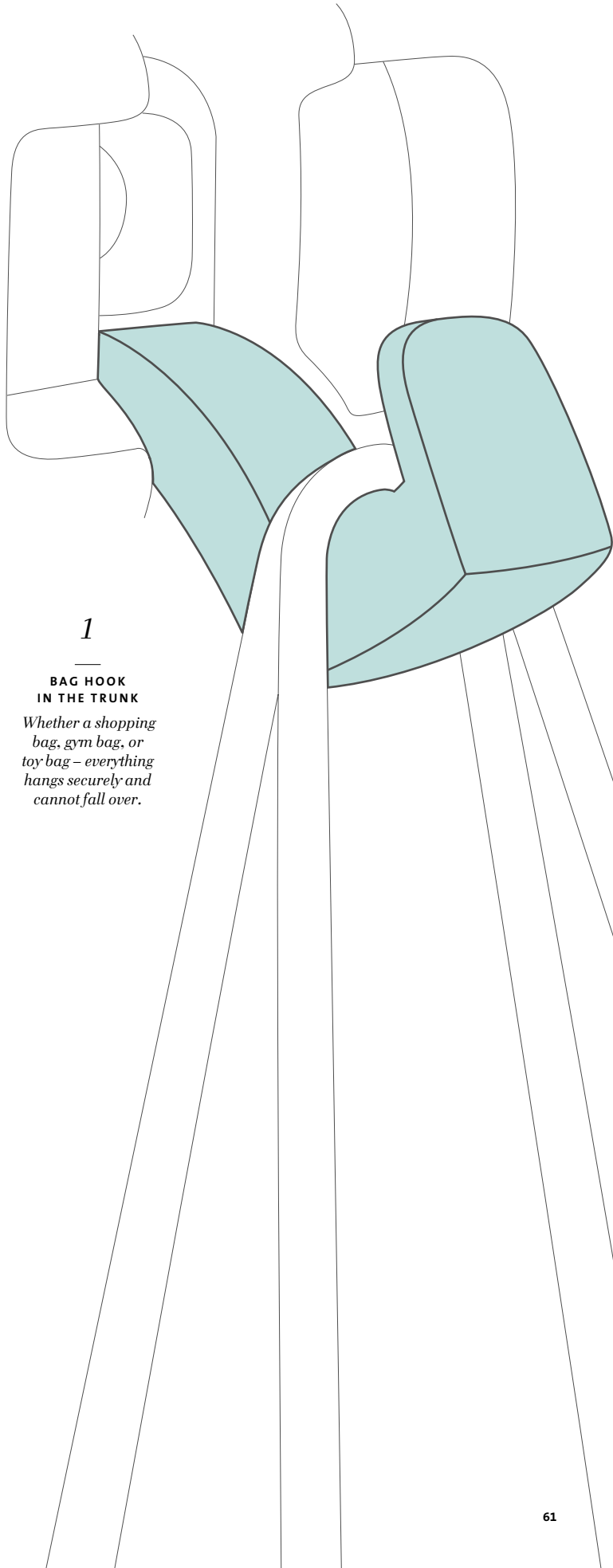

1

**BAG HOOK  
IN THE TRUNK**

*Whether a shopping bag, gym bag, or toy bag – everything hangs securely and cannot fall over.*

2

**ICE SCRAPER IN  
THE FUEL FILLER CAP**

*Snow – and later condensation – stay outside.*

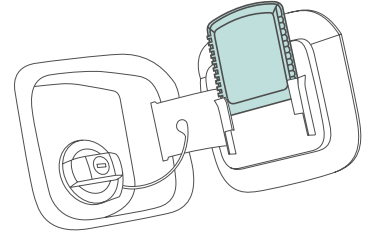

3

**PHONE HOLDER IN  
THE MIDDLE CONSOLE**

*The cell phone is stowed securely and is always within reach.*

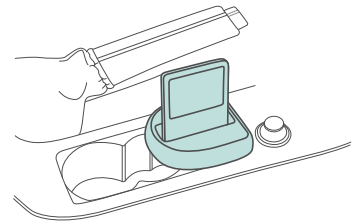

4

**PARK TICKET CLIP ON  
THE WINDSCREEN**

*Perfect for keeping parking tickets in place.*

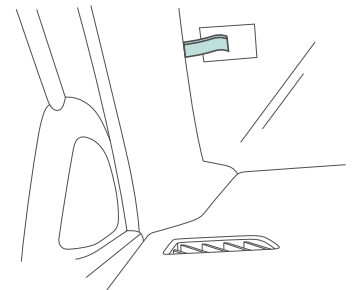

# *With all the senses*

Quality is more than perfect technology. You have to be able to feel, see, hear and smell it – and sometimes even taste it. That is why people in the Volkswagen Group work with all of their senses. Even a sense of speed.

TEXT: Johannes Winterhagen — PHOTOGRAPHY: Hartmut Nägele, Volkswagen AG



# *The smell specialist*

---

*Chemist Dr. Jörg Göldenitz (50) tests every  
new material used in the interior of a Volkswagen model.  
His most important tool? His nose.*

Many of the components in a car's interior are made out of plastic. They ensure a high level of safety and sophisticated design while keeping the weight to a minimum. In his laboratory in Wolfsburg, Göldenitz starts by carefully testing every new material to see whether it releases harmful or allergenic substances. If it passes this test, the chemist then grades the material's smell on a scale from one to six on the basis of small samples. Every new vehicle model is tested, too: the car is heated to desert temperature, for example, to be able to assess the smell when the doors are closed.

*“A new car has to smell  
pleasantly neutral. The driver should  
be able to concentrate  
on its appearance and handling.”*

---

DR. JÖRG GÖLDENITZ



The odor samples are as banal as they are ingenious: a piece is cut out of every material used in the interior and heated in a jar before undergoing an olfactory inspection. The entire car also has to go into the hot climate chamber prior to testing.

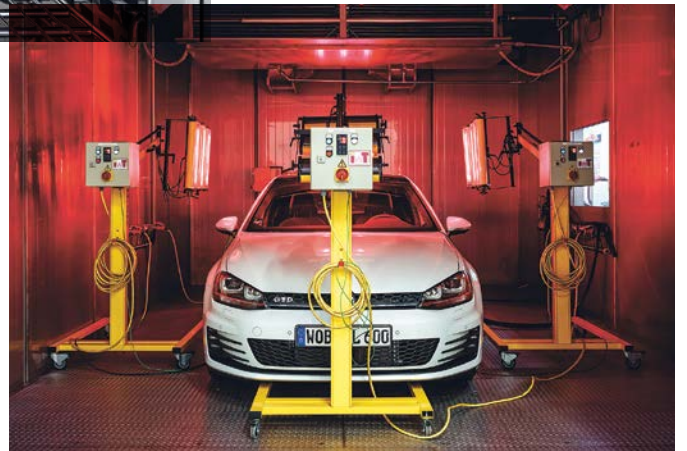



—  
*Audio samples: recording the motorcycle's  
sound primarily serves to  
review and confirm previous calculations.*



# *The sound composer*

---

*A Ducati is a Ducati if you can recognize the sound with your eyes closed. Acoustics expert Francesco Sini (39) is responsible for the characteristic roar of a Ducati engine.*

The “desmo” sound of a Ducati is legendary among motorcyclists. The word comes from the desmodromic valve – a mechanism that opens and closes the engine valves. One of Sini’s tasks is retaining the characteristic engine sound, even if legal requirements introduce stricter noise emission limits. As early as the development phase, Sini simulates how the motorcycle will later sound with the help of his computer. The high-precision acoustic work is then carried out in secret on the silencers in the exhaust line.

*“The characteristic engine sound  
is part of Ducati’s identity.”*

---

FRANCESCO SINI



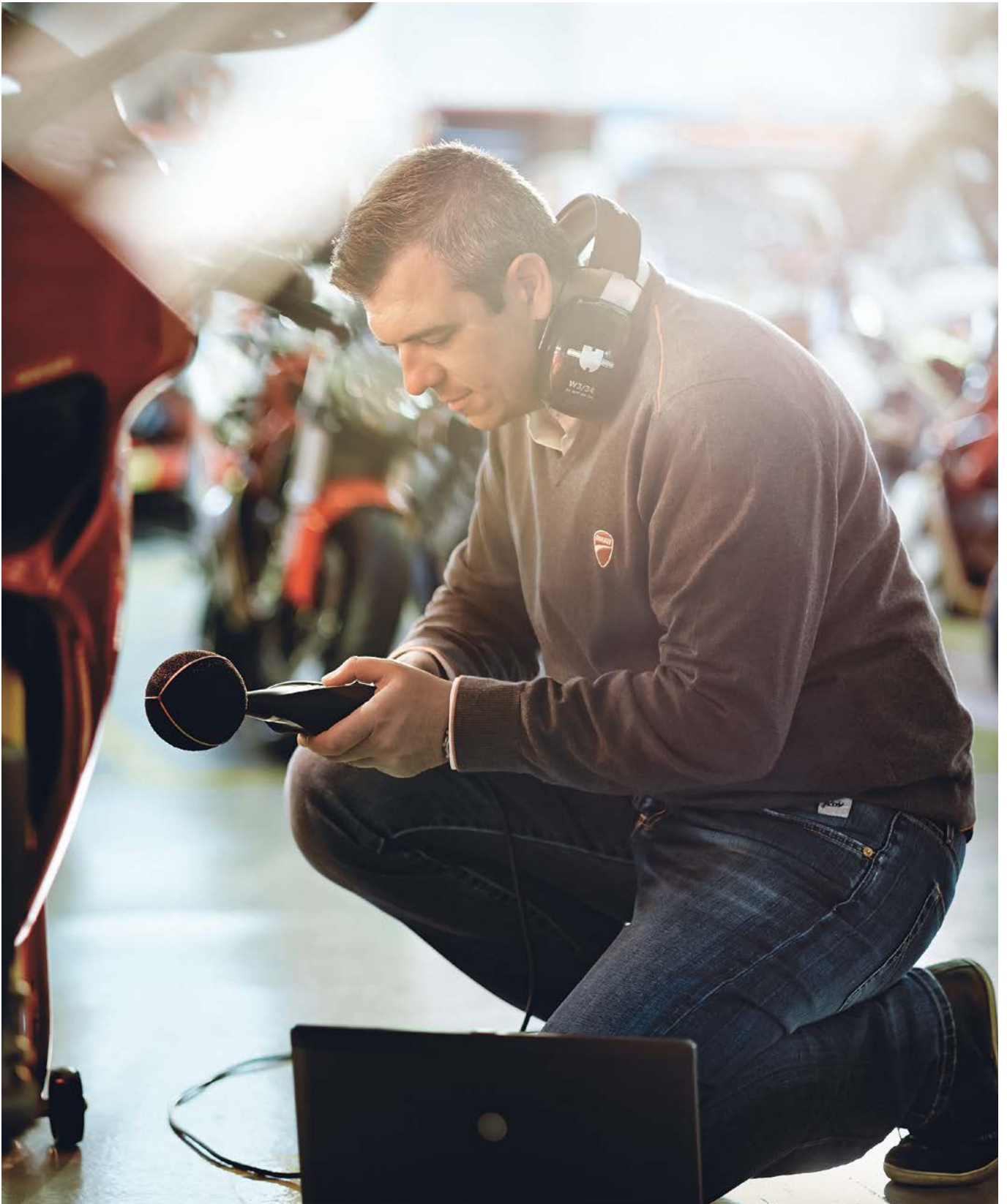

MOMENTUM\_EXPERIENCE  
*With all the senses*



# *The sight professional*

---

*Dr. Marcus Schneid (36) has his sights set firmly on quality.  
He assesses the ergonomic impact of Audi's new instrument panels and  
displays – even when there is no car to go with them yet.*

Large displays in the instrument cluster and in the center console make drivers' lives easier. Audi's aim is to always offer its customers the right information at the right time. In the ergonomic laboratory, Schneid evaluates whether the displays and instruments are easy to read – and don't just look good. Head-up displays, which project important information directly into the driver's field of vision, represent a particular challenge. Usually, you need a prototype vehicle for this. If it does not exist yet, Schneid uses a virtual reality helmet to test whether a display is user-friendly.

*“The display always has to be easy to read, regardless of how tall drivers are and how they sit in the car.”*

---

DR. MARCUS SCHNEID

*Seeing into the future: display developments  
can be viewed and evaluated in 3D before prototypes are built  
using a virtual reality helmet.*



Over six million portions of Volkswagen Currywurst are eaten every year. Taste tests are held regularly to ensure that only the best quality is served.



# *The taste virtuoso*

---

*Sandra Wickboldt (35) is not just the keeper of the quality of a cult object, Volkswagen Currywurst – as the head of food production and sales she is also responsible for new taste sensations.*

Its production numbers are unmatched by any other model: every year, over six million Currywurst portions – a German specialty featuring sausages in a curry sauce – leave the in-house butcher in Wolfsburg for destinations all around the world. Its main customers are company restaurants at Volkswagen's own plants. Wickboldt holds regular taste testing sessions with her master butchers and chefs to ensure that Volkswagen employees always get the very best quality. New creations from the test kitchen also find their way to the table. A fiery innovation recently passed the taste test – the extra spicy "Heaven & Hell" Currywurst sauce.

*“Volkswagen’s Currywurst is enjoyed  
all over the world.  
It’s now even produced in China.”*

---

SANDRA WICKBOLDT





MOMENTUM\_EXPERIENCE  
*With all the senses*



# *The touch expert*

---

*David Irving (30) aims to create the most comfortable car seat in the world. At Bentley, he develops not just elegant seating, but also countless adjustment and massage functions.*

Seat comfort for drivers and passengers depends on the quality of a number of principle elements, one such example being upholstery. Only perfect selection, composition and workmanship provide the combination of comfort and firmness that underscores the exclusive British brand's sporty, luxurious reputation. The adjustments integrated within the package by Irving work invisibly to ensure that the seat adapts itself individually to every occupant, even massaging them if they so wish. Irving's office is deliberately positioned next to the production and prototype facilities. Daily seat testing is part of his job.

*“Looking elegant is not enough.  
A good seat is also comfortable over  
extremely long distances.”*

---

DAVID IRVING

---

*Passionate about the perfect seat:  
the development of Bentley's seats combines technical  
expertise and fine craftsmanship.*



MOMENTUM\_EXPERIENCE  
*With all the senses*



# *The speed ace*

---

*Test driver Pierre-Henri Raphanel (52) teaches Bugatti's customers  
a special sixth sense – a sense of speed.  
This is vital for keeping the fastest series-produced cars in the world  
on the road at over 400 kilometers per hour.*

After sitting in a Bugatti Veyron<sup>1</sup> for the first time, Raphanel never wanted to get out again. Although the former Le Mans driver was used to driving at high speeds, never before had he felt so safe even when traveling at top speed. Ambitious Bugatti customers can also experience this feeling under Raphanel's guidance. What does it feel like? This calls for full concentration, says Raphanel. And in this particular case that means eliminating all other senses that could distract the driver from savoring this incredible moment in all its perfection.

*“My only previous experience  
of the same acceleration and speed  
as a Bugatti Veyron  
was in a thoroughbred racing car.”*

---

PIERRE-HENRI RAPHANEL



*Speed control: driving  
at over 400 km/h requires full concentration, even  
from professional drivers.*

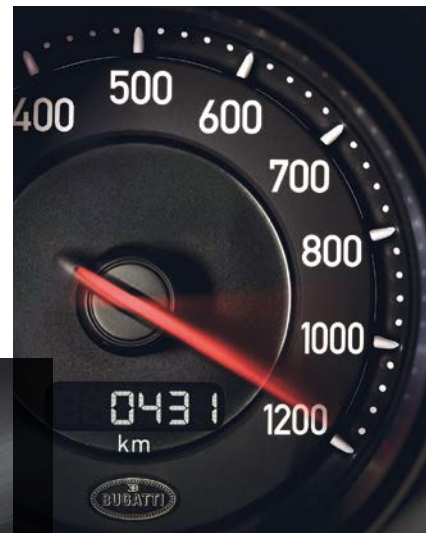

<sup>1</sup> Bugatti Veyron 16.4 Grand Sport Vitesse 882 kW fuel consumption in l/100 km urban 37.2 / extra-urban 14.9 / combined 23.1; CO<sub>2</sub> emissions in g/km combined 539.

---

**"SPIGOLOSA"**

*Lamborghini's design language is  
"angular" – the wedge shape  
unites generations of the sports car  
from Sant'Agata Bolognese.*

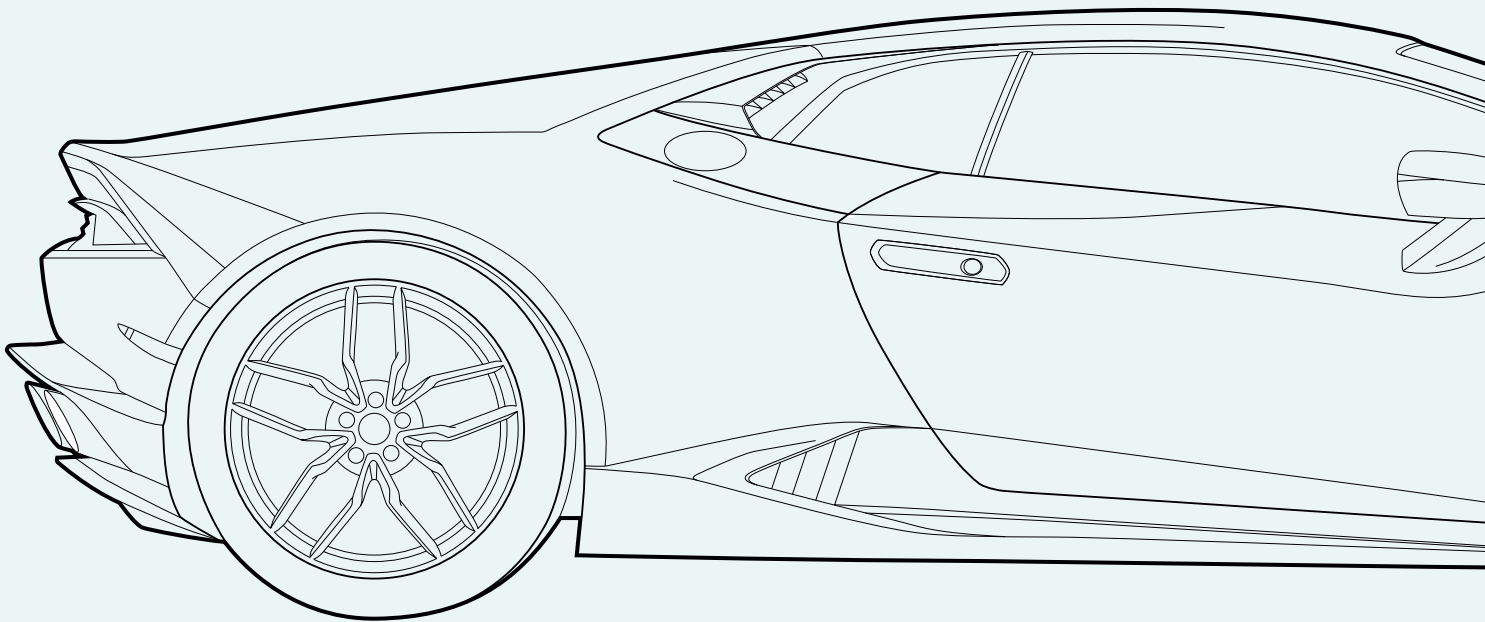

# *Pure form*

---

A Lamborghini is a Lamborghini, is a Lamborghini. Filippo Perini, the sports car manufacturer's Head of Design, explains what lies beneath the pure geometry of Italian design – and what that has to do with a big cat.

TEXT: *Dirk Maxeiner*

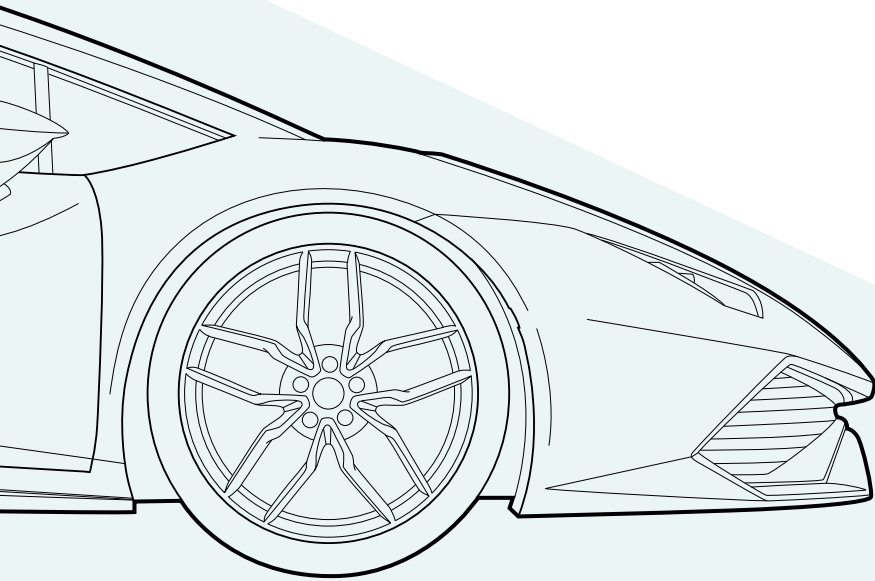

*Twenty-one. Twenty-two. Twenty-three.* In the time it takes to read these three numbers, a Lamborghini Huracán<sup>1</sup> can accelerate to over 100 km/h. And how long does it take to come to a standstill? Twenty-one. Twenty-two. About five seconds to get from zero to 100 and back. Now let's add a couple of bends and hills. Wow, this is a rollercoaster! Put it this way: Lamborghinis are some of the toughest thriller rides in the world. And they have been for 50 years – radical, uncompromising, extroverted.

In the Lamborghini Museum in Sant'Agata Bolognese, the Italian extreme sports car maker's home town, the display features one iconic car after another. Like the Countach, built in 1974. Design Director Filippo Perini calls the brand's traditional design language, already clearly visible in this particular model from the 1970s, "spigolosa", which is Italian for "angular". The wedge shape is the consistent element throughout the history of Lamborghini designs. This unmistakable form signals to the observer: the past is passé, the future a long, straight race track. In the beginning of 2014, the Lamborghini Huracán, true to the spirit of its predecessors, slices under the wind.

But not every wedge is identical. Countach and Huracán – each in its own right is a masterpiece of design, with its characteristic volume and tightly stretched skin. Its proportions and the wheels positioned far out to the sides simultaneously signal speed, strength and stability. "A Lamborghini is designed to hug the road", explains Perini.

His preferred way of answering questions about Lamborghini's design DNA is to take a pencil and paper. A paper napkin will do. "Beauty always works", says Perini as he draws an albatross, a cheetah, a shark. "The laws of physics are evident in the form of these wild animals", he explains. "They are ergonomically designed, they are beautiful and they function perfectly." People can tell instinctively whether an animal is fast or agile, aggressive or dangerous. This ability has been carved into our genetic makeup as a survival strategy. "That's why there are no misunderstandings when you see a Lamborghini." Whether it's the Countach or the Huracán.

1 Lamborghini Huracán 449 kW fuel consumption in l/100 km urban 17.8 / extra-urban 9.4 / combined 12.5; CO<sub>2</sub> emissions in g/km 290.

**LAMBORGHINI COUNTACH**

*A design jewel, built in 1974: sharp lines, uncompromising wedge shape, upwards-opening scissor doors.*

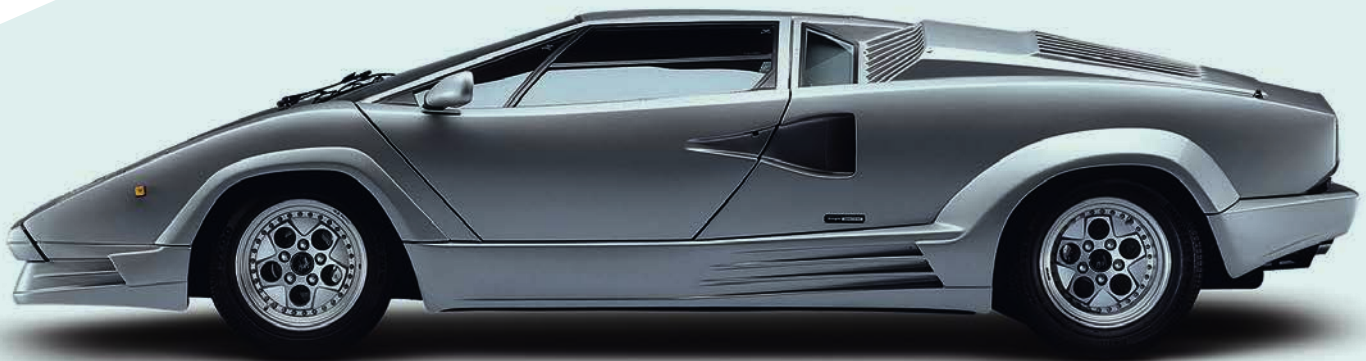

*“Beauty  
always works.”*

*Filippo Perini, Design Director Lamborghini*

**LAMBORGHINI HURACÁN**

*Powerful design language with an  
unmistakable silhouette:  
the side profile is characterized by  
hexagonal windows.*



*“We will be able to use the knowledge we have gained with the XL1 in other series in the future.”*

—  
THE LONG ROAD, PAGE 21

*Project manager Holger Bock on the XL1.*

*“An electric vehicle should not feel like an apology on wheels. It must be technically mature, perform well in everyday driving, and be safe and affordable.”*

—  
THE RIGHT MOMENT, PAGE 8

*Prof. Dr. Martin Winterkorn, Chairman of the Board of Management of Volkswagen AG, on the Group's wide range of hybrid and electric vehicles.*

# The last word

—  
There will probably never be a last word on “moving ideas” in the Volkswagen Group – but there is for this edition of Momentum. A look back.

*“We keep on learning all the time. That's the only way we will achieve things that seem impossible today.”*

—  
SMART DRIVING, PAGE 31

*Jörg Schlinkheider researches the driver assistance systems of the future for Audi.*

*“It's a wonderful feeling to be traveling so silently and to be so 'green', too.”*

—  
SHHH..., PAGE 54

*Pianist Lang Lang about his first drive in the e-up!*

*“We need this extra capacity because demand for mobility in China is booming.”*

—  
FUTURE FACTORY, PAGE 34

*Horst Kersten Gaudlitz, Plant Manager Changchun.*

*“The E-Hybrid is a truly groundbreaking achievement.”*

—  
LESS IS MORE, PAGE 42

*Dr. Gernot Döllner, the engineer responsible for the series and for developing the Panamera S E-Hybrid.*

*“Beauty always works.”*

—  
PURE FORM, PAGE 76

*Filippo Perini, Head of Design Lamborghini.*

# Imprint

---

## **PUBLISHED BY**

Volkswagen AG  
Group Communications  
Letterbox 1970  
38436 Wolfsburg  
Germany  
Phone +49 (0) 5361 9-0  
Fax +49 (0) 5361 9-28282  
www.volkswagenag.com

**CONCEPT, DESIGN AND REALIZATION**  
3st kommunikation, Mainz

## **EDITORIAL, TEXT**

Johannes Winterhagen, Tina Rumpelt

## **PRINTER**

Kunst- und Werbedruck, Bad Oeynhausen  
Printed in Germany

## **PAPER**

Druckfein neu, Römerturm

## **PHOTOGRAPHY, ILLUSTRATIONS, PICTURE CREDITS**

Marcos Camargo (p. 46-47)  
Nick Dimbleby (p. 73, right)  
Getty Images (cover)  
Matthias Haslauer (p. 27-29, 31, 48-49, 55)  
Guillem Hernández / Formula Student Spain (p. 58)  
Andreas Mader (p. 32-37, 40-42)  
Charlie Magee (p. 72)  
Hartmut Nägele (p. 19-20, 22-23, 62-71)  
Wolfgang Spaccarelli (p. 73, left)  
Göran Wink (p. 44-45)  
Volkswagen AG  
3st (p. 18, 21, 24-25, 30, 50-51, 61, 74-75)



