



Volkswagen

The Golf and Golf Estate



Contents.

04	The Golf and Golf Estate
06	Exterior
08	Interior
10	The Golf R-line
12	The Golf Alltrack
14	The Golf and Golf Estate GTD
20	The Golf GTI Performance
26	The Golf and Golf Estate R
32	The Golf GTE and GTE Advance
38	The e-Golf
44	Infotainment
48	Connectivity
50	Driver's assistance systems
52	Wheels – standard
54	Alloy wheels – optional
58	Paint
60	Upholstery
64	Combinations
68	Dimensions
72	Volkswagen service

Due to unprecedented demand, leading to long delivery lead times, Golf GTE is currently temporarily closed to ordering. For full details please consult your authorised Volkswagen retailer or visit www.volkswagen.co.uk

Front cover model shown is Golf R-Line with optional 18" 'Jurva' alloy wheels, LED headlights, LED rear light clusters, 'Vienna' leather upholstery and metallic paint.



Model shown is Golf R-Line with optional 18" 'Jurva' alloy wheels, panoramic sunroof, LED headlights, LED rear light clusters, 'Vienna' leather upholstery and metallic paint.

Beautifully designed. Technologically advanced.

Charismatic, confident and capable, the Golf and Golf Estate feature a powerful design and a wealth of technology. Latest generation infotainment systems and advanced driver assistance systems ensure you're equipped to handle just about anything everyday life can throw at you. And as you'd expect, it's all done with effortless style and flair. It's time to experience the future. Today.



01 The sporty radiator grille, striking headlights with LED daytime running lights, LED rear light clusters, uniquely shaped front and rear bumpers, sleek lines of the front wings and a stylish selection of alloy wheels and colours give this iconic car a strong road presence. Model shown is Golf R-Line with optional 18" 'Sebring' alloy wheels, LED headlights, LED rear light clusters and Oryx White premium signature paint.



Model shown is Golf R-Line with optional 18" 'Sebring' alloy wheels, LED headlights, LED rear light clusters and metallic paint.



Model shown is Golf Estate GTD with optional metallic paint.

Exterior.

With its powerful design, the Golf makes a real statement. The characteristic C-pillar, generous wheelbase and short overhangs create an unmistakable silhouette, while the uniquely shaped bumpers and radiator grille with extended chrome strip and headlights accentuate the width, creating presence and style.



01 The front of the Golf and Golf Estate is characterised by the instantly recognisable Golf styling. Changing with the times while remaining true to its heritage, the latest generation Golf delivers on every level. Model shown is Golf R-Line with optional 18 inch 'Jurva' alloy wheels, LED headlights, LED rear light clusters and metallic paint.

Interior.



01 The **Active Info Display** is a fully configurable, interactive 12.3 inch high resolution TFT display which replaces the standard analogue instrument cluster, displaying vehicle data and information on your dashboard. Five different modes allow you to customise the screen, with large or small dials as you prefer, and a number of items displayed behind them. When used in navigation mode, in conjunction with the Discover Navigation¹ or Discover Navigation Pro systems, you can move the speedometer and rev counter to the edge of the display, creating more space for the navigational map. If you wish, you can include driving, navigation and assistance functions within the graphics of the speedometer. As the Active Info Display is linked to all other assistance systems in the vehicle, any data shown in the centre console of the infotainment system, such as phone numbers or your music's compatible cover art, can also be displayed on the dash, conveniently placed directly within the driver's optimum field of vision. Standard on GTE, GTE Advance, GTD, GTD BlueLine, GTI Performance, R and Alltrack models, and optional on SE, SE Navigation, GT, R-Line and e-Golf models.

02 The **intelligent dashboard and controls** provide a gateway to the digital world, with a sophisticated design, larger infotainment touch-screens and intuitive operation. The large 9.2 inch display of the optional Discover Navigation Pro system features a stylish glass surface, with higher resolution display, sharper graphics clearly showing all the relevant information you need, and operable with touch, voice and gesture control. In addition, decorative trim panels in the door, dash and centre console, along with a selection of stylish seat upholsteries, allow you to personalise your Golf to your taste, creating your own interior ambience.

¹ When the navigation map is displayed in the Active Info Display in conjunction with the Discover Navigation system, the navigation map cannot be displayed on the Discover Navigation's 8.0" infotainment touch-screen.



02

R-Line.

More distinctive than ever, the dynamic R-Line features the unique 'R-Line' styling pack, comprising a number of sporty exterior touches such as uniquely shaped bumpers, side skirts, spoilers, radiator grille and badging, and a luxurious interior, with front sports seats and aesthetic detail, creating the look and feel of a real sports performer.



01 Front sports seats are ergonomically designed for both comfort and style. Finished in contemporary 'R-Line' cloth in the centre section with 'San Remo' microfibre side bolsters, and the 'R-Line' logo displayed on the front seat backrests, not only do they look good, but also provide excellent lateral support when cornering, while lumbar support for the driver and front seat passenger ensures maximum comfort on every journey.

02 The 'R-Line' styling pack includes specially designed front and rear bumpers, a distinctive radiator grille, gleaming black front air intake and side skirts, creating a powerful, athletic look, complemented by sporty 17 inch 'Singapore' alloy wheels, chrome effect trapezoid dummy exhaust tailpipe surrounds to the left and right, and unique 'R-Line' badging. A rear roof spoiler provides additional downforce to the rear axle when accelerating.



02

Model shown is Golf R-Line with optional 18" 'Sebring' alloy wheels, panoramic sunroof, LED headlights, LED rear light clusters and Oryx White premium signature paint.



Model shown is Golf Alltrack with optional 18" 'Kalamata' alloy wheels, Winter pack and metallic paint.

Alltrack.

Looking to add a little spice to your everyday life? With increased ground clearance and heavy-duty running gear, roof rails and 4MOTION, the Golf Alltrack is ready for most adventures. Switch to 'Off-road' mode to optimise traction control, enjoy smooth driving down steep inclines with hill descent assist, and maximise the potential of the turbocharged engine by utilising the paddle shift. The 4MOTION four wheel drive system transfers torque between the front and rear wheels, delivering reliable traction on almost any ground, allowing you to go off-the-beaten-track with confidence and ease. Adventure here you come.



01 The passenger compartment of the Golf Alltrack is designed to impress with its **high quality materials** and advanced features. Stylish 'Alltrack' upholstery or optional 'Vienna' perforated leather adds a touch of luxury, enhanced by 'Polar Night Black' decorative inserts in the centre console, and 'Piano Black' trim in the dash and door panels. The front centre armrest is equipped with a storage box for your phone, keys and other items, and two air vents behind it benefit the rear seat passengers. The rear passenger seat features a folding armrest, ideal for use as a table and providing extra storage or load-through options. Image shown features optional Discover Navigation Pro touch-screen navigation/DVD infotainment system, Dynamic Chassis Control (DCC), panoramic sunroof and metallic paint.



02 The Discover Navigation touch-screen navigation/infotainment system with Car-Net 'Guide and Inform'¹ builds upon the impressive Composition Media system, but with additional features enabling you to easily manage not only your music, but also navigation data and a broad range of vehicle information. The system offers Volkswagen Media Control², which allows remote control of the infotainment system via a smartphone or tablet, preloaded European navigation data, 2D/3D map view which can be easily followed on the 8.0 inch colour touch-screen, three calculated route choices (Fast, Short and Eco), dynamic navigation based on TMC+, branded points of interest and Speed Limit Display³, while 3-years' Car-Net 'Guide and Inform' access makes it possible to integrate 'traffic information online' into route guidance and transfer public and personal points of interest to the navigation system. The service also includes information for fuel location and pricing, weather and news feeds.

¹ Car-Net 'Guide and Inform' services are accessed via a compatible mobile device. Please see www.volkswagen.co.uk for more information. The use of 'Guide and Inform' services entails exchanging large volumes of data. As such, we strongly recommend that you sign-up for a flat rate data plan with your mobile network provider. After the initial 3-year Car-Net contract, an annual subscription is chargeable for the continuation of Car-Net 'Guide and Inform' services.

² Only operable in conjunction with compatible tablets and smartphones including iPhone 5 and above. Please see www.volkswagen.co.uk to check compatibility.

³ Speed Limit Display only reflects national speed limits and does not show temporary speed limit restrictions, or where permanent changes to speed limits are made in-between map updates.

Make way for the GTD sports performers.

The Golf and Golf Estate top diesel performer is here in the form of the GTD, delivering excellent performance and handling, along with dynamic body styling and refined interiors, and equipped with a host of advanced features. Equally at home on long or short trips, it really comes into its own on the open road, delivering high levels of responsiveness and control. Power combines with economy in the Golf GTD in one unbeatable package. GTD styling, flared sill strips and lowered sports suspension hint at its capability, while the 2.0 litre 184 PS TDI diesel engine is built to perform and designed to thrill. The Golf GTD delivers pure driving enjoyment mile after mile.



Exterior.



01

01 18 inch 'Seville' alloy wheels underline the dynamic character of the Golf GTD and Golf GTD Estate, combining with the all-LED headlights featuring dynamic curve lighting, LED daytime running lights, headlight washers and front fog lights to create a powerful exterior. Specify the GTD BlueLine model and **17 inch 'Curitiba' alloy wheels** are fitted as standard which improve drive characteristics, and also CO₂ emissions on the hatch model.

02 Illuminated door sill protectors provide an eye-catching detail as you open the door, helping to protect against scuffs and scrapes as you enter and exit your Golf GTD.

03 The rear of the Golf GTD and Golf GTD Estate is distinctive and dynamic, displaying restyled **LED tinted rear light clusters**, a rear roof spoiler and a 'Black' diffuser with chrome twin exhaust tailpipe, giving emphasis to the unique 'GTD' badging. On Golf GTD Hatch models, the rear indicators feature an **indicator sweep function** which makes your manoeuvring intentions even more noticeable to other road users, as well as being an exterior styling highlight.



02



Model shown is Golf Estate GTD with optional metallic paint.

Interior.



01 The intelligent dashboard and controls open up the digital world, featuring an **Active Info Display** with large 12.3 inch high resolution dash display screen that shows all relevant information and can be personalised to your individual driving preference. Heated front sports seats are upholstered in 'Jacara Grey' cloth, complementing the grey stitching around the leather trimmed three-spoke multifunction steering wheel with 'GTD' logo and gear knob gaiter. Stainless steel pedals provide a sporting detail, enhanced by the black rooflining and 'Honeycomb Black' decorative inserts in the dash and door panels.



Interior shown is Golf GTD with optional Discover Navigation Pro touch-screen navigation/DVD infotainment system and metallic paint.



The GTI Performance, are you ready for this much power?

Cool, stylish and even more powerful, the Golf GTI Performance delivers exhilarating performance and pure driving pleasure. Unique exterior styling creates a powerful road presence, while sports running gear and lowered sports suspension helps hug the road, especially on corners. With its turbocharged 2.0 litre TSI petrol engine delivering 245 PS and with plenty of driver assistance systems, the Golf GTI Performance is all you'd expect and more. Are you ready?



Exterior.



01 The GTI Performance's 'Parker' 18 inch alloy wheels are dynamic and stylish complete with large red brake callipers that are adorned with the iconic 'GTI' logo adding a sporting touch.

02-03 The rear of the Golf GTI Performance is characterised by a 'Black' diffuser with new, larger chrome exhaust tailpipes to the left and right, a body-coloured rear roof spoiler and unique 'GTI' badging with distinctive red finish. New, tinted LED rear light clusters with indicator sweep function complete the picture, giving a dynamic look at night.



Model shown is Golf GTI Performance with optional 19" 'Brescia' alloy wheels and Tornado Red non-metallic paint.



Interior.



02

01-02 As soon as you open the door of the Golf GTI Performance with its illuminated red door sill panels and 'GTI' badging, you'll be inspired. Heated front sports seats are upholstered in 'Jacara Red' cloth and feature height and lumbar adjustment, ensuring optimal support when cornering. The **leather trimmed three-spoke multifunction steering wheel** displays eye-catching red stitching and the 'GTI' logo, with matching gear knob gaiter, enhanced by 'Honeycomb Black' decorative inserts in the dash and door panels. Stainless steel pedals give a real sports feel, while the Active Info Display, with 12.3 inch high resolution screen, allows you to keep an eye on the performance of your vehicle when driving, and 2Zone electronic air conditioning with automatic air recirculation and allergy filter ensures an ambient interior temperature throughout the cabin. Interior shown features optional 'Sports Honeycomb' Art Velours cloth and Tornado Red non-metallic paint.

The ultimate performer.

Ready to go at a moment's notice, the Golf R delivers sheer, unadulterated power. Sports-tuned suspension and 4MOTION all-wheel drive ensure control and comfort, while the powerful 2.0 litre TSI petrol engine delivers power exactly when and where you need it. Are you ready to go?



01-02 There's no mistaking the dynamic Golf R, with its uniquely shaped bumpers, 'R' radiator grille with matt-chrome strip, side sills and matt-chrome effect door mirrors, enhanced by 18 inch 'Cadiz' alloy wheels with 'Black' brake callipers adorned with 'R' logo.





Model shown is Golf R 4MOTION with optional 19" 'Pretoria' alloy wheels and Lapiz Blue metallic signature paint.

Exterior.



02

01 The rear of the R is dynamic and sporty, with the 'Black' diffuser featuring twin oval chrome exhaust tailpipes to the left and right, rear roof spoiler and unique 'R' badging completing the look. Image shown features optional Lapiz Blue metallic signature paint.

02 18 inch 'Cadiz' alloy wheels combined with lowered 'R' sports suspension, give the look of a true sports performer and are exclusive to the R model.



Interior



01-02 The sleek interior includes ambient lighting, a unique 'R' instrument cluster and gear lever knob, and front sports seats upholstered with 'Race' cloth seat centre section, grey Art Velours side bolsters and embroidered 'R' logo. 'Carbon Touch' decorative inserts in the dash and door panels, a leather trimmed multifunction three-spoke steering wheel with 'R' logo and gear knob gaiter, and unique 'R' design key add to the exclusive sporty feel. Image shown features optional Discover Navigation Pro touch-screen navigation/DVD infotainment system.

Due to unprecedented demand, leading to long delivery lead times, Golf GTE is currently temporarily closed to ordering. For full details please consult your authorised Volkswagen retailer or visit www.volkswagen.co.uk



Dynamic versus sustainable? Why not have both?

Combining GTI dynamics with e-Golf sustainability, the Golf GTE offers the best of both worlds. When fully charged in all-electric mode, this exciting hybrid has a maximum range of up to 28 miles¹ on the GTE Advance and 30 miles¹ on the GTE. Press the GTE button to combine the electric motor with the 1.4 litre TSI petrol engine, delivering up to an impressive 204 PS, reaching a top speed of 138mph, where the law permits.



¹ The specified NEDC range can vary because of driving style, speed, use of additional electrical consuming equipment, outside temperature, number of people in car/maximum load, driving style selection (e-mode, hybrid, battery hold, battery charge or 'GTE' mode) and terrain. Please consult your Volkswagen retailer for full details or visit the Volkswagen website at www.volkswagen.co.uk

Exterior.



01



02

01 The LED tinted rear light clusters with indicator sweep function are elegantly integrated into the rear design, giving a distinctive look, especially at night. A rear roof spoiler, rear diffuser in 'Black' with chrome twin exhaust tailpipe and unique 'GTE' badging add real sports style.

02 The Golf GTE and GTE Advance are equipped with remote electrically foldable door mirrors featuring reverse activated kerb-view adjustment on the passenger's door mirror and door mirror puddle lights which illuminate the area for added convenience at night or in poor light.

Due to unprecedented demand, leading to long delivery lead times, Golf GTE is currently temporarily closed to ordering. For full details please consult your authorised Volkswagen retailer or visit www.volkswagen.co.uk



Model shown is Golf GTE with optional Oryx White premium signature paint.

Due to unprecedented demand, leading to long delivery lead times, Golf GTE is currently temporarily closed to ordering. For full details please consult your authorised Volkswagen retailer or visit www.volkswagen.co.uk



Interior.

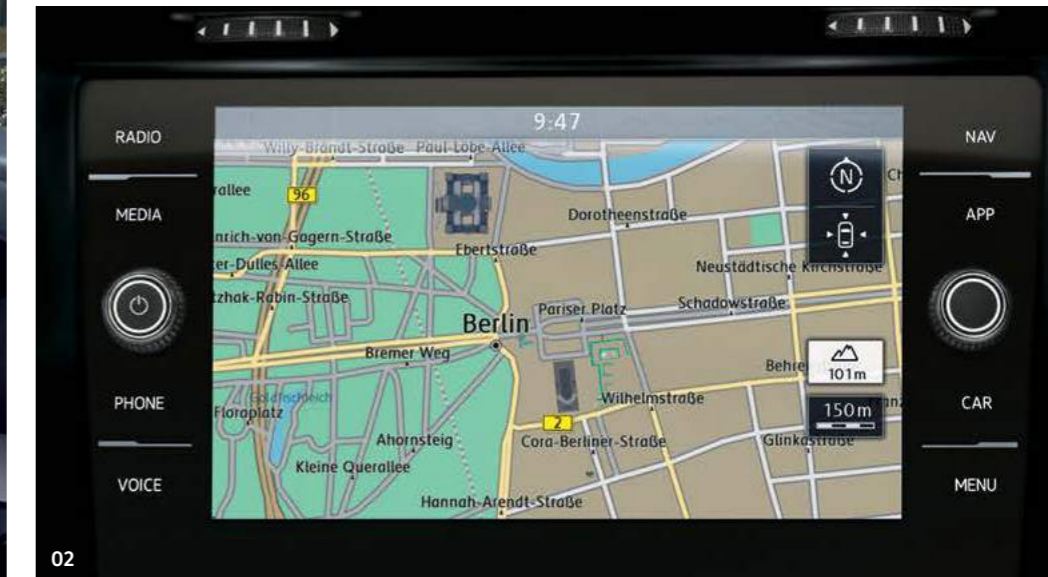

01 Sporty, refined and understated, the luxurious interior is equipped with a unique 'GTE' instrument cluster and 'Honeycomb Black' decorative inserts in the dash and door panels creating real atmosphere at night. Front sports seats are upholstered in 'Jacara Blue' upholstery and are height and lumbar adjustable to ensure the optimum seating position. The **leather trimmed three-spoke multifunction steering wheel is finished in contrast blue stitching with the 'GTE' logo** and has a matching gear knob gaiter. Black rooflining and stainless steel brake and accelerator pedals complete the sporty look, with progressive steering and 2Zone electronic air conditioning adding to the driving enjoyment.

02 Specify the GTE Advance and you get the **Discover Navigation touch-screen navigation/infotainment system with Car-Net 'Guide and Inform'**¹ which builds upon the impressive Composition Media system found in the GTE. The additional features enable you to easily manage not only your music, but also navigation data and a broad range of vehicle information. The system offers Volkswagen Media Control², which allows remote control of the infotainment system via a smartphone or tablet, preloaded European navigation data, 2D/3D map view which can be easily followed on the 8.0 inch colour touch-screen, three calculated route choices (Fast, Short and Eco), dynamic navigation based on TMC+, branded points of interest, Speed Limit Display³ and 3-years' Car-Net 'Guide and Inform' access makes it possible to integrate 'traffic information online' into route guidance and transfer public and personal points of interest to the navigation system. The service also includes information for fuel location and pricing, weather and news feeds.

¹ Car-Net 'Guide and Inform' services are accessed via a compatible mobile device. Please see www.volkswagen.co.uk for more information. The use of 'Guide and Inform' services entails exchanging large volumes of data. As such, we strongly recommend that you sign-up for a flat rate data plan with your mobile network provider. After the initial 3-year Car-Net contract, an annual subscription is chargeable for the continuation of Car-Net 'Guide and Inform' services.

² Only operable in conjunction with compatible tablets and smartphones including iPhone 5 and above. Please see www.volkswagen.co.uk to check compatibility.

³ Speed Limit Display only reflects national speed limits and does not show temporary speed limit restrictions, or where permanent changes to speed limits are made in-between map updates.



The future looks familiar.

Take a step forward towards a future of sustainable motoring. With a range of up to 186 miles¹, the e-Golf is the ideal vehicle for everyday use. Whether driving around town, doing the school run, shopping, socialising or going to work, the e-Golf delivers responsive performance and plenty of driving enjoyment whilst producing zero emissions when the vehicle is in motion.

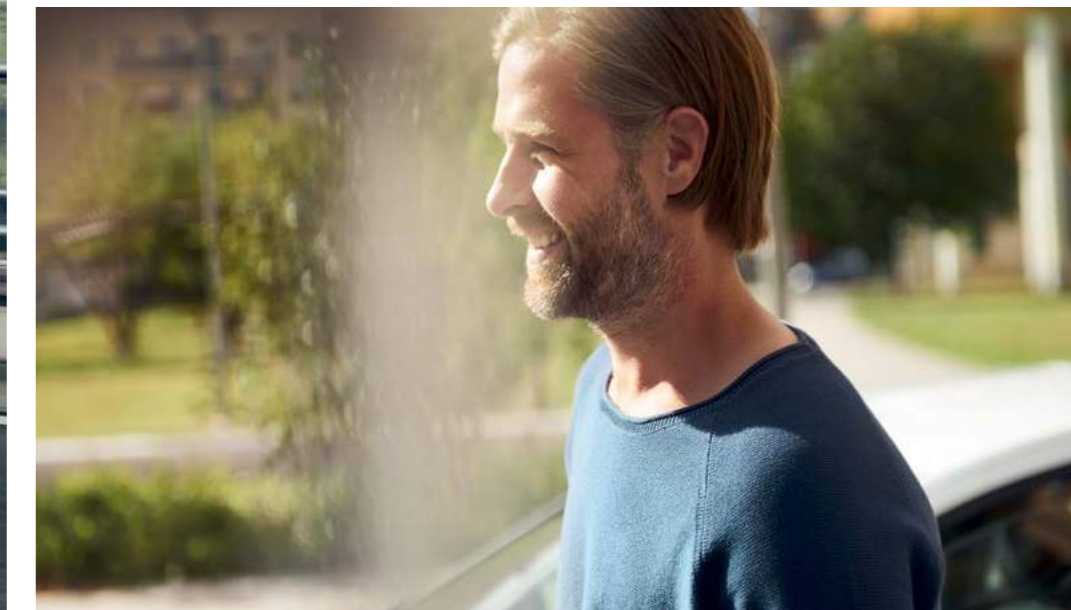

¹ The specified NEDC range can vary because of driving style, speed, use of additional electrical consuming equipment, outside temperature, number of people in car/maximum load, driving style selection (normal, ECO, ECO+) and terrain. Please consult your Volkswagen retailer for full details or visit the Volkswagen website at www.volkswagen.co.uk

Exterior.

Futuristic yet reassuringly familiar, it's plain to see that you are driving a very special Golf. The unique e-Golf badging adorning the front and rear, the blue stripe on the aerodynamic front grille that extends through to the LED headlights and the striking design of the LED daytime running lights with their unique 'C' signature look symbolise the e-Golf's distinctive individuality and all-electric zero emission¹ environmental credentials.



01 In addition to the e-Golf's distinctive blue styling hints, an impressive range of exterior and interior specification enhance the e-Golf, such as 16 inch 'Tillevé' alloy wheels with 205/55 R16 low rolling resistance tyres, unique 'e-Golf' instrument cluster, Discover Navigation Pro infotainment system with Volkswagen Media Control and a range of Car-Net online mobile services and helpful apps. Model shown is e-Golf with optional Winter pack and Pure White non-metallic paint.

02 From the rear, the e-Golf creates a lasting impression with the 'e-Golf' styling pack comprising uniquely shaped bumpers, rear roof spoiler and side sills. The LED tinted rear light clusters with indicator sweep function are not only a stylish design feature, but also alert other drivers to the intention to turn more effectively.

¹ Zero emissions while driving.



Model shown is e-Golf with optional rear tinted windows and Pure White non-metallic paint.

Interior.

The interior of the e-Golf continues the theme with contrast blue decorative stitching on the leather trimmed three-spoke multifunction steering wheel and gear knob. The Discover Navigation Pro touch-screen navigation/DVD infotainment system includes integrated voice activation, gesture control and Car-Net 'Guide and Inform Plus' can be operated intuitively via the 9.2 inch colour touch-screen. The multifunction colour display and power meter will also help you keep an eye on the most important information about your vehicle as well as your journey.



01 Car-Net 'Guide and Inform Plus'¹ gives you online access to a wide range of useful information, such as weather, exciting destinations in your surrounding area, nearby parking spaces or the next filling station. You can also receive the latest traffic information with recommendations for avoiding congestion or news and weather feeds from the Internet.

¹ Car-Net 'Guide and Inform' and 'Guide and Inform Plus' services are accessed via a compatible mobile device. Please see www.volkswagen.co.uk for more information. The use of 'Guide and Inform' services entails exchanging large volumes of data. As such, we strongly recommend that you sign-up for a flat rate data plan with your mobile network provider. After the initial 3-year Car-Net contract, an annual subscription is chargeable for the continuation of Car-Net 'Guide and Inform' services. Please see www.volkswagen.co.uk to check smartphone compatibility.



Interior shown is e-Golf with optional Active Info Display, 'Vienna' leather upholstery, carpet mats and Pure White non-metallic paint.



01

Interior shown is Golf R-Line with optional Discover Navigation Pro touch-screen navigation/DVD infotainment system, climate control – 2Zone electronic air conditioning and metallic paint.

Infotainment.

The Golf and Golf Estate incorporate the latest generation infotainment systems, providing advanced levels of connectivity and intuitive operation, utilising touch-screens, voice control, phone operation and, for the first time ever, gesture control.



02



03

01-02 Innovative gesture control enables you to operate the Discover Navigation Pro touch-screen navigation/DVD infotainment system with the greatest of ease. Using a simple sideways swiping gesture, you can scroll through the main menu, change radio stations, flip through the playlist or browse through your picture viewer or albums in the media library. Successful swipes are confirmed by a sound effect that can be deactivated if you wish. Standard on e-Golf and optional on SE Navigation, GT, R-Line, GTE, GTE Advance, GTD, GTD BlueLine, GTI Performance, R and Alltrack models as part of the Discover Navigation Pro touch-screen navigation/DVD infotainment system.

03 The 'Dynaudio Excite' soundpack produces phenomenal sound, delivering 400 watt output via an ten channel digital amplifier and eight speakers located around the cabin. The Digital Signal Processor (DSP) maximises the sound from each speaker, ensuring every seat is in the optimum listening position. Optional on SE, SE Navigation, GT, R-Line, GTD, GTD BlueLine, GTI Performance, R and Alltrack models



01



02

1 Devices must be Bluetooth HFP (Hands Free Profile) compatible, please contact your authorised Volkswagen retailer for specific phone compatibility.
 2 Speed Limit Display only reflects national speed limits and does not show temporary speed limit restrictions, or where permanent changes to speed limits are made in-between map updates.
 3 Car-Net 'Guide and Inform' and 'Guide and Inform Plus' services are accessed via a compatible mobile device. Please see www.volkswagen.co.uk for more information. The use of 'Guide and Inform' services entails exchanging large volumes of data. As such, we strongly recommend that you sign-up for a flat rate data plan with your mobile network provider. After the initial 3-year Car-Net contract, an annual subscription is chargeable for the continuation of Car-Net 'Guide and Inform' services.
 4 Only operable in conjunction with compatible tablets and smartphones including iPhone 5 and above. Please see www.volkswagen.co.uk to check compatibility.

01 The **Composition Media infotainment system** is equipped with an 8.0 inch colour touch-screen, DAB digital radio receiver, Multi Device Interface (MDI), single CD player, SD card reader and USB connection. It allows music playback from MP3, WMA and AAC files, simultaneous pairing of two compatible mobile devices, SMS functionality (when stationary and on compatible Android smartphones only), Bluetooth telephone and audio functionality¹, and provides driver tips and journey analysis via the 'Think Blue. Trainer.' Eight speakers, situated to the front and rear, deliver 4 x 20 watt output. Standard on S, SE, and GTE models.

02 The **Discover Navigation touch-screen navigation/infotainment system** adds navigational functionality to the 'Composition Media' system, providing dynamic navigation based on TMC+, branded points of interest, preloaded European navigation data, Speed Limit Display² and three routes (Fast, Short and Eco), and 2D/3D map view. It comes with 3-years' Car Net 'Guide and Inform'³, providing online access to such information as traffic, fuel pricing, weather and news feeds; and includes online navigation software updates, enabling you to download the latest map data. The system also offers Volkswagen Media Control⁴, which allows remote control of the infotainment system via a smartphone or tablet. Standard on SE Navigation, GT, R-Line, GTE Advance, GTD, GTD BlueLine, GTI Performance, R and Alltrack and optional on S and GTE.

03 The **Discover Navigation Pro touch-screen navigation/DVD infotainment system** features a glass-covered 9.2 inch colour touch-screen for navigation, DVD, CD and radio functions. It responds to spoken voice commands for navigation and telephone functions, and also features gesture control for use with various different menus, responding to a sideways swiping gesture and confirming a successful swipe with a sound effect, which can be deactivated if required. Building on the Composition Media specification, it is equipped with a 64 GB SSD hard drive, The system offers Volkswagen Media Control⁴, allowing remote control of the infotainment system via a smartphone or tablet, preloaded European navigation data, 3D map view, three calculated routes (Fast, Short and Eco), dynamic navigation based on TMC+, branded points of interest, Speed Limit Display², photo display from JPEG and PNG files and two SD card readers. It comes with 3-years' Car Net 'Guide and Inform Plus'³, providing online access to such information as traffic, fuel pricing, weather and news feeds; and includes online navigation software updates, enabling you to download the latest map data. Standard on e-Golf and optional on SE Navigation, GT, R-Line, GTE, GTE Advance, GTD, GTD BlueLine, GTI Performance, R and Alltrack models.

03



Interior shown is Golf GT with optional Discover Navigation Pro touch-screen navigation/DVD infotainment system and 2Zone electronic air conditioning.

A virtual world at your fingertips.

Thanks to Car-Net connectivity you can enjoy a whole range of online services while you travel, helping to make your journey easier, more comfortable and ultimately more informed. As well as enjoying up-to-the-minute information, you can also access many of your favourite apps from your smartphone, all conveniently displayed on the infotainment system's touch-screen display.



Model shown is Golf R-Line with optional panoramic sunroof, 'Vienna' leather upholstery and metallic paint.



01 Car-Net 'Security & Service'¹ acts as your personal assistant supporting you in every driving situation and providing you with all the key information you need regarding your mobility. An integrated SIM-card provides continuous connectivity and interaction between the driver, vehicle and Volkswagen's call centre or server. In the event of an accident, should the driver activate the 'eCall' button or the airbags are deployed triggering the 'eCall' service, Volkswagen's Emergency Centre will be contacted directly. Key information such as the condition and location of the vehicle will be sent to emergency response units. In the event of minor incidents, the 'Automatic accident notification' can send location and vehicle details to the Volkswagen Emergency Centre should the driver wish. Additional data is also shared including details of 'Car breakdown', 'Vehicle health report' and 'Service schedule' ensuring your vehicle's information is always up to date – 10-year subscription included.

The service also allows vehicle information to be accessed via the Car-Net Portal or Car-Net app, via a laptop or smartphone, from the comfort of your home or even the office. Information such as 'Driving data', the status of 'Doors and lights', 'Area alert', 'Speed alert', remote control of 'Horn and hazard lights', 'Parking position' and 'Online anti-theft alarm' can be easily accessed and monitored – 3-year subscription included. Standard on GT, R-Line, GTE Advance, GTD, GTD BlueLine, GTI Performance, R and Alltrack and optional on SE and SE Navigation.



02 With Car-Net 'Guide and Inform'², your Golf becomes a mobile network using your smartphone's Wi-Fi hotspot. **Car-Net 'Guide and Inform'**¹ gives you online access to a wide range of useful information, such as weather, exciting destinations in your surrounding area, nearby parking spaces or the next filling station. You can also receive the latest traffic information with recommendations for avoiding congestion or news and weather feeds from the Internet. Car-Net 'Guide and Inform' is standard on the Discover Navigation touch-screen navigation/infotainment system. Standard on SE Navigation, GT, R-Line, GTE Advance, GTD, GTD BlueLine, GTI Performance, R and Alltrack and optional on S and GTE. Opting for the Discover Navigation Pro touch-screen navigation/DVD infotainment system means that you can benefit from 'Guide and Inform Plus'². Standard on e-Golf and optional as part of the Discover Navigation Pro touch-screen navigation/DVD infotainment system on SE Navigation, GT, R-Line, GTE, GTE Advance, GTD, GTD BlueLine, GTI Performance, R and Alltrack models.

03 Car-Net 'App-Connect'³ allows your Golf to connect with current Apple and Android smartphones through three innovative technologies: Apple 'CarPlay', Google 'Android Auto' and 'MirrorLink'TM. This enables you to 'mirror' your smartphone's most important functions, such as phone contacts, news and music, on the touch-screen of your infotainment system, enabling you to operate them simply and safely during your journey. Please note, there is usage of only certified apps while driving. Optional on S and standard on all other models. Image shown features optional Discover Navigation Pro touch-screen navigation/DVD infotainment system.

¹ Use of Car-Net 'Security & Service' is governed in a separate Contract concluded online with Volkswagen. The customer has 90 days after vehicle handover to register the vehicle at www.volkswagen.com/car-net. This will enable the customer to use Services for the full period of validity. The Emergency Call Service is already activated when the vehicle is delivered, without registration being required. Availability of Car-Net Services may vary depending on the country in question. The services are available during the agreed contractual period and may be subject to amendments during the duration of the contract. To use the free Car-Net app you will need a smartphone with iOS or Android operating system and a SIM-card with a data option. You will also need an appropriate mobile phone contract already in place or separately arranged with your mobile phone provider. Depending on your mobile tariff, sending and receiving data online may incur additional charges (e.g. roaming charges), particularly if you are using Car-Net abroad. For more information on Car-Net Security & Service, go to www.volkswagen.com/car-net or contact your Volkswagen retailer. For information on your mobile tariff rates, please contact your mobile phone provider.

² Car-Net 'Guide and Inform' and 'Guide and Inform Plus' services are accessed via a compatible mobile device. Please see www.volkswagen.co.uk for more information. The use of all 'Guide and Inform' services entails exchanging large volumes of data. As such, we strongly recommend that you sign-up for a flat rate data plan with your mobile network provider. After the initial 3-year Car-Net contract, an annual subscription is chargeable for the continuation of all 'Guide and Inform' services.

³ Only operable in conjunction with compatible smartphones including iPhone 5 and above. Please see www.volkswagen.co.uk to check smartphone compatibility.

Due to unprecedented demand, leading to long delivery lead times, Golf GTE is currently temporarily closed to ordering. For full details please consult your authorised Volkswagen retailer or visit www.volkswagen.co.uk

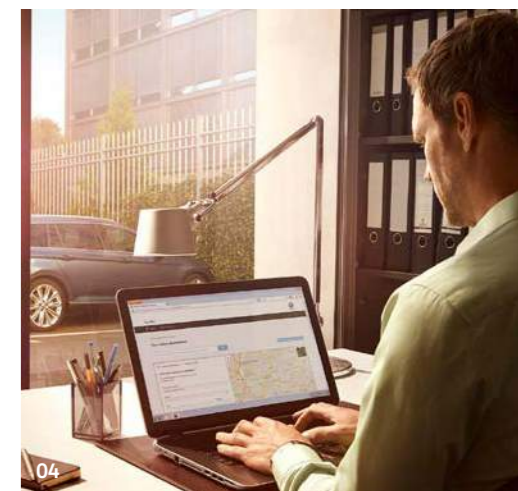

04 The Volkswagen Car-Net Destination Import allows you to search for destinations from the comfort of your home or office and send them directly to your Golf's navigation system. Simply log into the Volkswagen Car-Net portal, click 'Online destination import' and search for wherever you wish to go. Find your destination, save it, name it, and then send it to your Golf's navigation system. Your named destinations will then be displayed under 'My Destinations' on the main navigation display screen, it's that easy. You can also similarly send your 'Personal points of interest' from your computer or tablet and download them to your Golf's navigation system and they will appear on the navigation screen as you drive. Standard on SE Navigation models and above, and optional on S models as part of the Discover Navigation touch-screen navigation/infotainment system.

Driver's assistance systems.

Intelligent driver assistance systems ensure greater comfort and convenience on your journey, and can help you to overcome or avoid potentially critical situations.

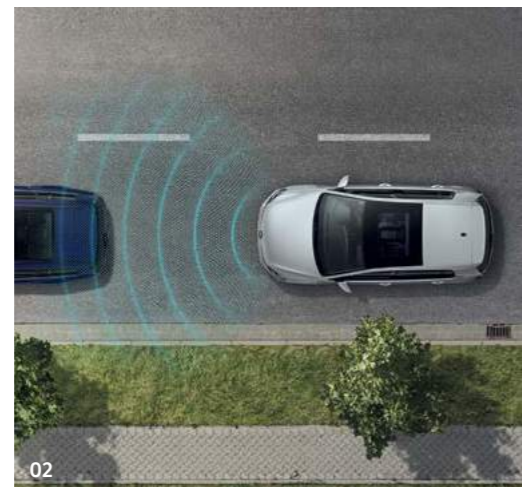
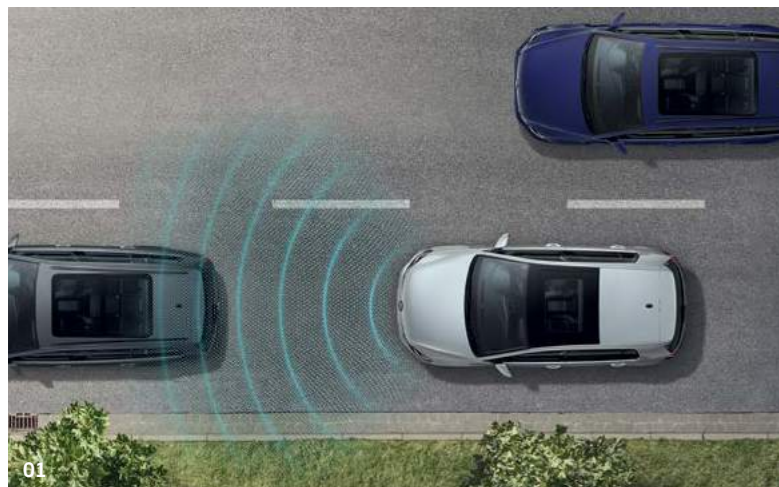

01 Traffic Jam Assist is a camera and radar sensor controlled warning system that helps you keep your distance in congested traffic and avoid a typical congestion type collision. Should your vehicle drift out of lane, the system accelerates, brakes and steers as appropriate, as long as it detects the driver's hands on the wheel. Optional on SE Navigation models and above as part of one of the Lane Assist Plus options on 5-door DSG models only.

02 Adaptive Cruise Control (ACC) including Front Assist radar sensor controlled distance monitoring system, City emergency braking system, cruise control and speed limiter, offers you intelligent control of your driving speed by automatically adjusting acceleration and braking. Whether around town or on the motorway, the system will adjust your speed to that of the vehicle in front, keep your specified distance, warn if you are approaching too fast and, in an emergency situation, generate enough braking force to try to reduce the severity of a collision or possibly even prevent the collision entirely. Standard on SE models and above. Front Assist, the radar sensor controlled distance monitoring system is standard when choosing S models.

03 Predictive Pedestrian Protection features a camera and radar sensor controlled warning system. This alerts you should it detect any pedestrians at the edge of the road or on the carriageway, via acoustic and optical signals as well as a gentle jolt of the brakes. Standard on all models.

04 Trailer Assist including Park Assist helps you reverse a trailer or caravan with a weight of up to 1,800kg into a parking bay or entrance from the street. To operate, simply engage reverse gear and activate the system via a push button. The driving angle and possible driving angles are displayed on the instrument cluster. All the driver has to do is operate the accelerator pedal and brake, while the system automatically controls the direction of the car, using the joystick (mirror adjustment switch) to move the trailer backwards into the required position. Optional on SE, SE Navigation, GT, R-Line, GTE, GTE Advance, GTD, GTD BlueLine, GTI Performance and Alltrack models. Must be ordered in conjunction with optional towbar – swivelling.

Due to unprecedented demand, leading to long delivery lead times, Golf GTE is currently temporarily closed to ordering. For full details please consult your authorised Volkswagen retailer or visit www.volkswagen.co.uk



05 The Active Info Display is a fully configurable, interactive 12.3 inch TFT display which replaces the standard analogue instrument cluster, displaying vehicle data and information on your dashboard. Five different modes allow you to customise the screen, with large or small dials as you prefer, and a number of items displayed behind them. When used in navigation mode, in conjunction with the Discover Navigation¹ or Discover Navigation Pro systems, you can move the speedometer and rev counter to the edge of the display, creating more space for the navigational map. If you wish, you can include driving, navigation and assistance functions within the graphics of the speedometer. As the Active Info Display is linked to all other assistance systems in the vehicle, any data shown in the centre console of the infotainment system, such as phone numbers or your music's compatible cover art, can also be displayed on the dash, conveniently placed directly within the driver's optimum field of vision. Standard on GTE, GTE Advance, GTD, GTD BlueLine, GTI Performance, R and Alltrack models. Optional on SE, SE Navigation, GT, R-Line and e-Golf models.

¹ When the navigation map is displayed in the Active Info Display in conjunction with the Discover Navigation system, the navigation map cannot be displayed on the Discover Navigation's 8.0" infotainment touch-screen.

Wheels – standard.

01 6J x 15" steel wheels with 195/65 R15 tyres and full size wheel trims.

02 'Linás' 6½J x 16" alloy wheels with 205/55 R16 tyres and anti-theft wheel bolts.

03 'Dijon' 7J x 17" alloy wheels with 225/45 R17 tyres and anti-theft wheel bolts.

04 'Singapore' 7J x 17" alloy wheels with 225/45 R17 tyres and anti-theft wheel bolts.

05 'Seville' 7½J x 18" alloy wheels with 225/40 R18 tyres and anti-theft wheel bolts.

06 'Curitiba' 7½J x 17" alloy wheels with 225/45 R17 tyres and anti-theft wheel bolts.

07 'Parker' 7½J x 18" alloy wheels with 225/40 R18 tyres and anti-theft wheel bolts.

08 'Cadiz' 7½J x 18" alloy wheels with 225/40 R18 tyres and anti-theft wheel bolts.

09 'Rio De Janeiro' 7½J x 17" alloy wheels with 225/45 R17 tyres and anti-theft wheel bolts.

10 'Marseille' 7½J x 18" alloy wheels with 225/40 R18 tyres and anti-theft wheel bolts.

11 'Tillevé' 6½J x 16" alloy wheels with 205/55 R16 tyres low rolling resistance tyres and anti-theft wheel bolts.

12 'Valley' 6½J x 17" alloy wheels with 205/55 R17 tyres and anti-theft wheel bolts.

■ Standard □ Optional

Golf | GO Golf Estate | GE

S | S SE and SE Navigation | SE GT | GT R-Line | RL GTD | GTD GTD BlueLine | GTD BL

GTI Performance | GTI R | R GTE | GTE GTE Advance | GTE A e-Golf | E Alltrack | AT

Images shown feature optional non-metallic, metallic and metallic signature paint.

Due to unprecedented demand, leading to long delivery lead times, Golf GTE is currently temporarily closed to ordering. For full details please consult your authorised Volkswagen retailer or visit www.volkswagen.co.uk



01 Steel wheels

GO, GE **S**



02 'Linás'

GO, GE **SE**



03 'Dijon'

GO, GE **GT**



04 'Singapore'

GO **RL**



05 'Seville'

GO, GE **GTD**



06 'Curitiba'

GO, GE **GTD BL**



07 'Parker'

GO **GTI**



08 'Cadiz'

GO, GE **R**



09 'Rio De Janeiro'

GO **GTE**



10 'Marseille'

GO **GTE A**



11 'Tillevé'

GE **E**



12 'Valley'

GE **AT**

Alloy wheels – optional.



01 'Lyon'

GO, GE S



02 'Karlskoga'

GO, GE SE GT



03 'Madrid'

GO, GE SE GT



04 'Madrid Blue'

GO, GE SE GT



05 'Jurva'

GO GT RL
GE GT



06 'Marseille'

GO RL



07 'Sebring'

GO RL

01 'Lyon' 6J x 15" alloy wheels with 195/65 R15 tyres and anti-theft wheel bolts.

02 'Karlskoga' 7J x 17" alloy wheels with 225/45 R17 tyres and anti-theft wheel bolts.

03 'Madrid' 7J x 17" alloy wheels with 225/45 R17 tyres and anti-theft wheel bolts.

04 'Madrid Blue' 7J x 17" alloy wheels with 225/45 R17 tyres and anti-theft wheel bolts.

05 'Jurva' 7½J x 18" alloy wheels with 225/40 R18 tyres and anti-theft wheel bolts.

06 'Marseille' 7½J x 18" alloy wheels with 225/40 R18 tyres and anti-theft wheel bolts.

07 'Sebring' 7½J x 18" alloy wheels with 225/40 R18 tyres and anti-theft wheel bolts.

Standard Optional

Golf | GO Golf Estate | GE

S | S SE and SE Navigation | SE GT | GT R-Line | RL GTD | GTD GTD BlueLine | GTD BL

GTI Performance | GTI R | R GTE | GTE Alltrack | AT

Images shown feature optional non-metallic and metallic paint.

Due to unprecedented demand, leading to long delivery lead times, Golf GTE is currently temporarily closed to ordering. For full details please consult your authorised Volkswagen retailer or visit www.volkswagen.co.uk

Alloy wheels – optional (continued).



GO GTD



GO GTD



GO GTI



GO GTI

08 'Brescia' 7½J x 19" alloy wheels with 225/35 R19 tyres and anti-theft wheel bolts.

09 'Santiago' 7½J x 19" alloy wheels with 225/35 R19 tyres and anti-theft wheel bolts.

10 'Seville Dark Graphite' 7½J x 18" alloy wheels with red pinstripe, 225/40 R18 tyres and anti-theft wheel bolts.

11 'Brescia' 7½J x 19" alloy wheels with 225/35 R19 tyres and anti-theft wheel bolts.

12 'Santiago' 7½J x 19" alloy wheels with 225/35 R19 tyres and anti-theft wheel bolts.

13 'Pretoria' 8J x 19" alloy wheels with 235/35 R19 tyres and anti-theft wheel bolts.

14 'Pretoria Black' 8J x 19" alloy wheels with 235/35 R19 tyres and anti-theft wheel bolts.

15 'Spielberg' 8J x 19" alloy wheels with 235/35 R19 tyres and anti-theft wheel bolts.

16 'Kalamata' 7½J x 18" alloy wheels with 225/45 R18 tyres and anti-theft wheel bolts.

Standard Optional

Golf | GO Golf Estate | GE

S | S SE and SE Navigation | SE GT | GT R-Line | RL GTD | GTD GTD BlueLine | GTD BL

GTI Performance | GTI R | R GTE | GTE Alltrack | AT



GO GTI



GO, GE R



GO, GE R



GO, GE R



GE A

Images shown feature optional non-metallic and metallic paint.

Paint.

01 Pure White Non-Metallic 0Q

02 Urano Grey Non-Metallic 5K

03 Tornado Red Non-Metallic G2

04 Turmeric Yellow Metallic 6T

05 Reflex Silver Metallic 8E

06 Isaac Blue Steel Metallic 8P

07 Atlantic Blue Metallic H7

08 Tungsten Silver Metallic K5

09 White Silver Metallic K8

10 Cranberry Red Metallic V8

11 Indium Grey Metallic X3

12 Lapiz Blue Metallic Signature L9

13 Deep Black Pearl Effect 2T

14 Oryx White Premium Signature 0R

Standard Optional

Golf | GO Golf Estate | GE

S | S SE and SE Navigation | SE GT | GT R-Line | RL GTD and GTD BlueLine | GTD GTI Performance | GTI R | R GTE and GTE Advance | GTE e-Golf | E Alltrack | AT

Please note: Colour range is reproduced for illustration purposes only. Actual on-car colours may vary from those shown, as screen technology does allow exact reproduction of the paint colours. Please note that some colours shown are not available on certain trims. Please see key for available paint finishes. Images shown include optional equipment. Image 02 is e-Golf.

Due to unprecedented demand, leading to long delivery lead times, Golf GTE is currently temporarily closed to ordering. For full details please consult your authorised Volkswagen retailer or visit www.volkswagen.co.uk



GO S SE GT RL GTD GTI R GTE E
GE S SE GT GTD R AT



GO S SE GT RL E
GE S SE GT AT

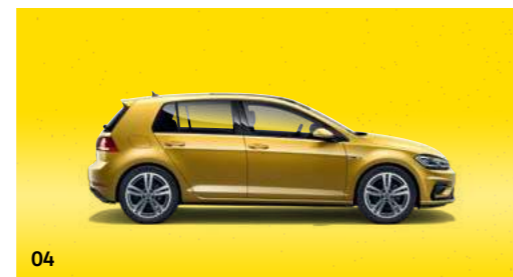

GO S SE GT RL R E
GE S SE GT R



GO GTD GTI GTE
GE GTD



GO S SE GT GTD GTI GTE E
GE S SE GT GTD AT



GO S SE GT RL GTD GTI R GTE E
GE S SE GT GTD R



GO S SE GT RL GTD GTI R GTE E
GE S SE GT GTD R AT



GO S SE GT RL GTD GTI R GTE E
GE S SE GT GTD R AT



GO S SE GT GTD GTI GTE E
GE S SE GT GTD AT



GO R
GE R



GO SE GT RL GTD GTI R GTE E
GE SE GT GTD R AT



GO S SE GT RL GTD GTI R GTE E
GE S SE GT GTD R AT

Upholstery – standard.

Standard on S models

01 'Bella' cloth Titan Black TW

Standard on SE and SE Navigation models

02 'Zoom' cloth Titan Black TW

03 'Zoom' cloth Shetland XW

Standard on GT models

04 Art Velours seat centre section with 'Global' cloth side bolsters Titan Black/Quartz TW

05 Art Velours seat centre section with 'Global' cloth side bolsters Shetland/Shetland XW

Standard on R-Line models

06 'R-Line' cloth seat centre section with 'San Remo' microfibre side bolsters Titan Black TW

Standard on GTD and GTD BlueLine models

07 'Jacara Grey' cloth Titan Black TW

Standard on GTI Performance models

08 'Jacara Red' cloth Titan Black/Red TW

Standard on R models

09 'Race' cloth seat centre section with grey Art Velours side bolsters Titan Black TW

Standard on GTE and GTE Advance models

10 'Jacara Blue' cloth Titan Black/Blue TW

Standard on e-Golf models

11 'Zoom' cloth Titan Black TW

Standard on Alltrack models

12 'Alltrack' cloth seat centre section with Alcantara side bolsters Titan Black TW

Standard Optional

Golf | **GO** Golf Estate | **GE**

S | **S** SE and SE Navigation | **SE** GT | **GT** R-Line | **RL** GTD and GTD BlueLine | **GTD**

GTI Performance | **GTI** R | **R** GTE and GTE Advance | **GTE** e-Golf | **E** Alltrack | **AT**

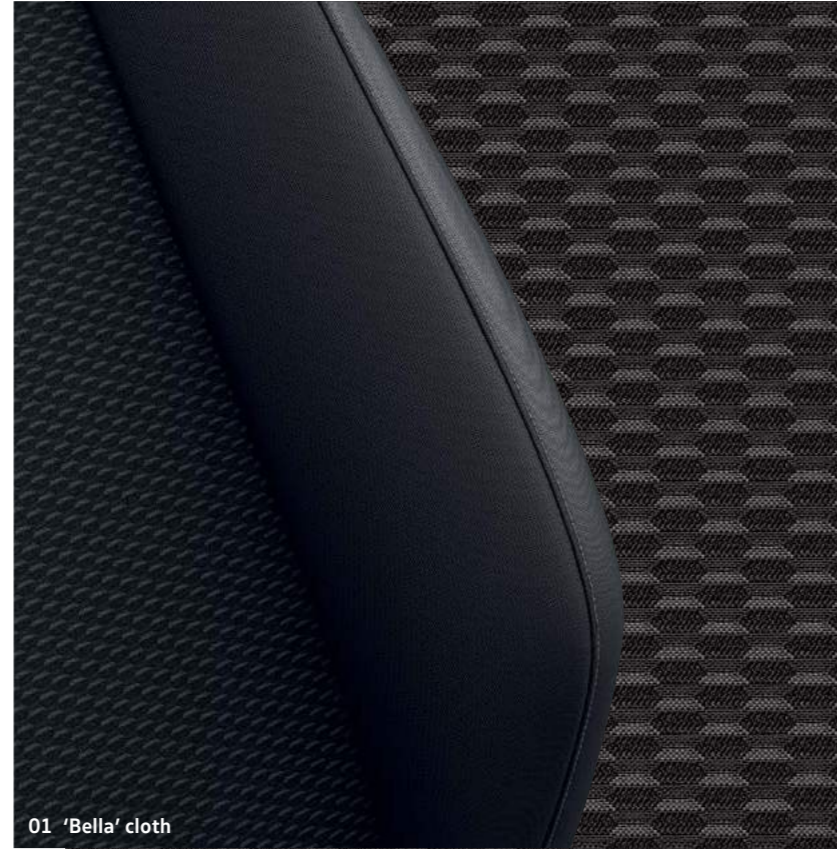

01 'Bella' cloth

GO, GE **S**

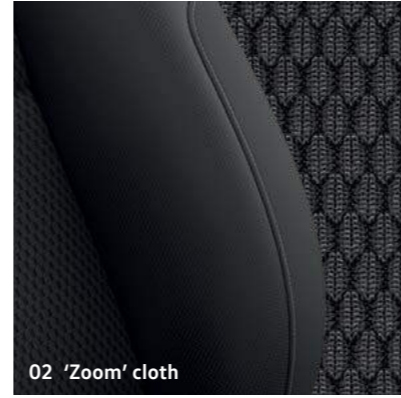

02 'Zoom' cloth

GO, GE **SE**



03 'Zoom' cloth

GO, GE **SE**

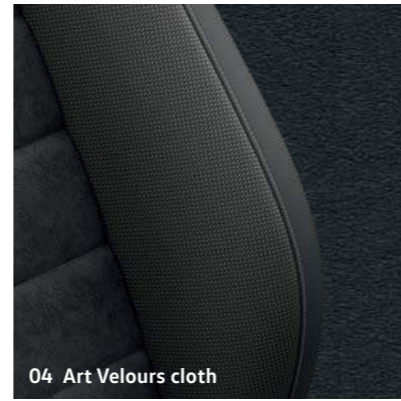

04 Art Velours cloth

GO, GE **GT**

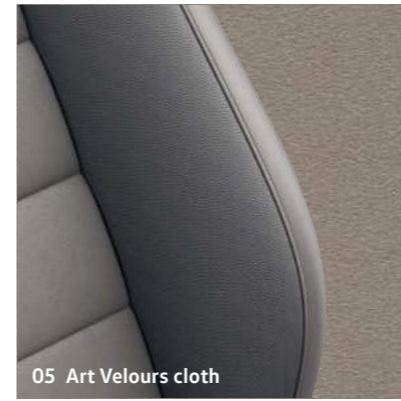

05 Art Velours cloth

GO, GE **GT**



08 'Jacara Red' cloth

GO **GTI**



11 'Zoom' cloth

GO **E**



06 'R-Line' cloth

GO **RL**

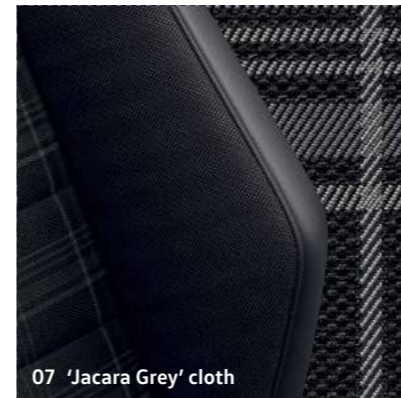

07 'Jacara Grey' cloth

GO, GE **GTD**

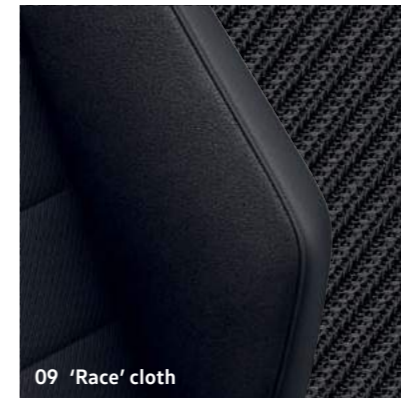

09 'Race' cloth

GO, GE **R**



10 'Jacara Blue' cloth

GO **GTE**



12 'Alltrack' cloth

GE **AT**

Please note: Swatches reproduced for illustration purposes only. Actual upholstery colours may vary from those shown, as screen technology does not allow exact reproduction of the upholstery colours.

Due to unprecedented demand, leading to long delivery lead times, Golf GTE is currently temporarily closed to ordering. For full details please consult your authorised Volkswagen retailer or visit www.volkswagen.co.uk

Upholstery – optional.

Optional on SE, GT and e-Golf models

- 01 'Vienna' perforated leather* Black TW
- 02 'Vienna' perforated leather* Pure Grey UW
- 03 'Vienna' perforated leather* Shetland XW

Optional on Alltrack models

- 04 'Vienna' perforated leather* Black TW
- 05 'Vienna' perforated leather* Pure Grey UW

Optional on R-Line, GTD, GTD BlueLine, R, GTE and GTE Advance models

- 06 'Vienna' perforated leather* Black TW

Optional on GTI Performance models

- 07 'Vienna' perforated leather* Black/Red TW

Optional on GTD, GTD BlueLine, GTE and GTE Advance models

- 08 'Sports Honeycomb' Art Velours cloth Black/Flint Grey TW

Optional on GTI Performance models

- 09 'Sports Honeycomb' Art Velours cloth Black/Red TW

Optional on R models

- 10 'Carbon/Nappa' leather* Black TW
- 11 'Carbon/Nappa' leather* Grey IB

■ Standard □ Optional

Golf | GO Golf Estate | GE

S | S SE and SE Navigation | SE GT | GT R-Line | RL GTD and GTD BlueLine | GTD GTI Performance | GTI R | R GTE and GTE Advance | GTE e-Golf | E Alltrack | AT

* Some parts of leather interior will contain artificial leather. Please note that from late November 2018, only the front seats are perforated and not the rear seats.
Please note: Swatches reproduced for illustration purposes only.
Actual upholstery colours may vary from those shown, as screen technology does not allow exact reproduction of the upholstery colours.

Due to unprecedented demand, leading to long delivery lead times, Golf GTE is currently temporarily closed to ordering. For full details please consult your authorised Volkswagen retailer or visit www.volkswagen.co.uk



01 'Vienna' leather
GO SE GT E
GE SE GT

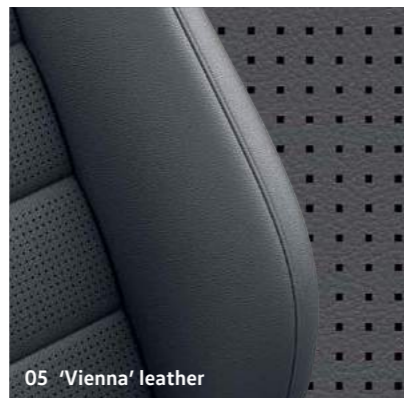

05 'Vienna' leather
GE AT

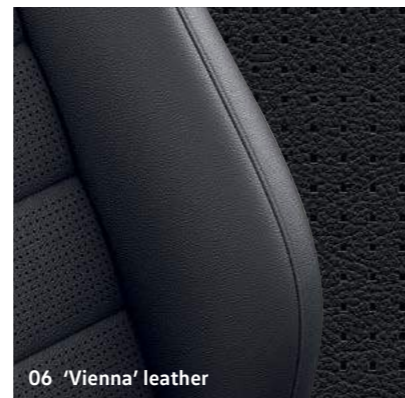

06 'Vienna' leather
GO RL GTD R GTE
GE GTD R

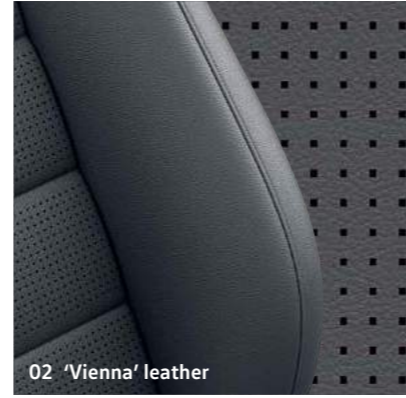

02 'Vienna' leather

GO SE GT E
GE SE GT

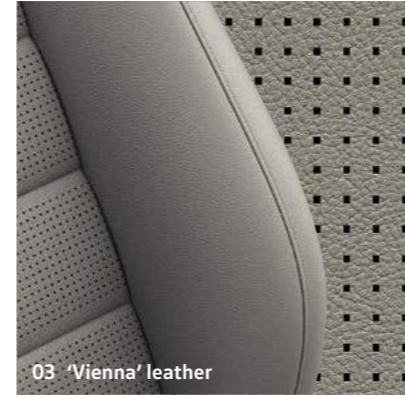

03 'Vienna' leather

GO SE GT E
GE SE GT



04 'Vienna' leather

GE AT

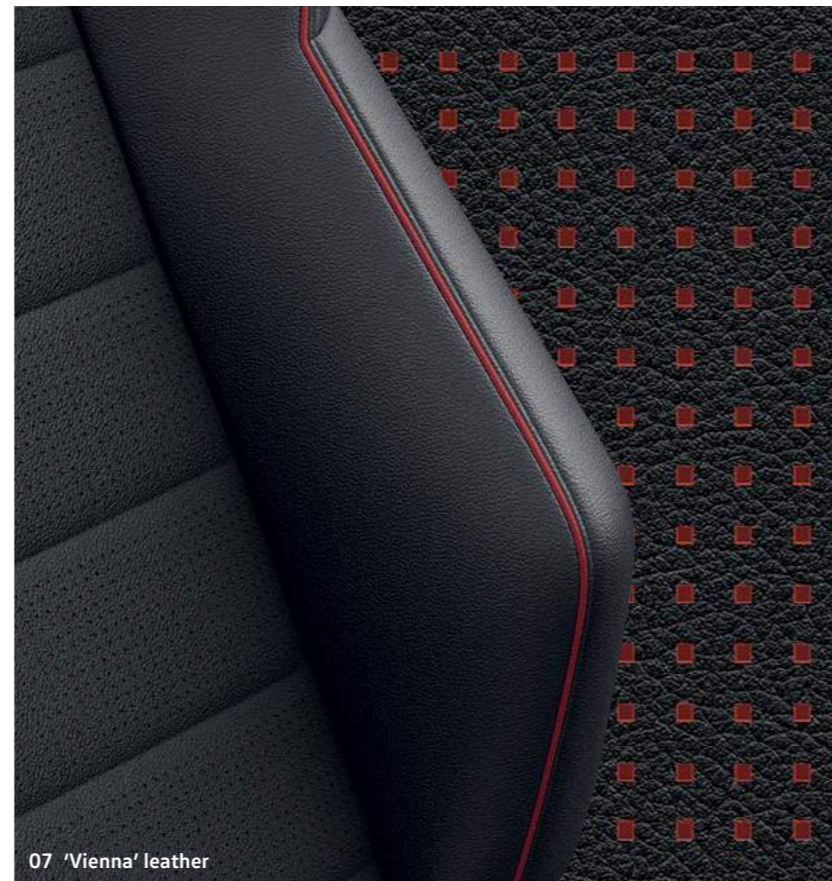

07 'Vienna' leather

GO GTI

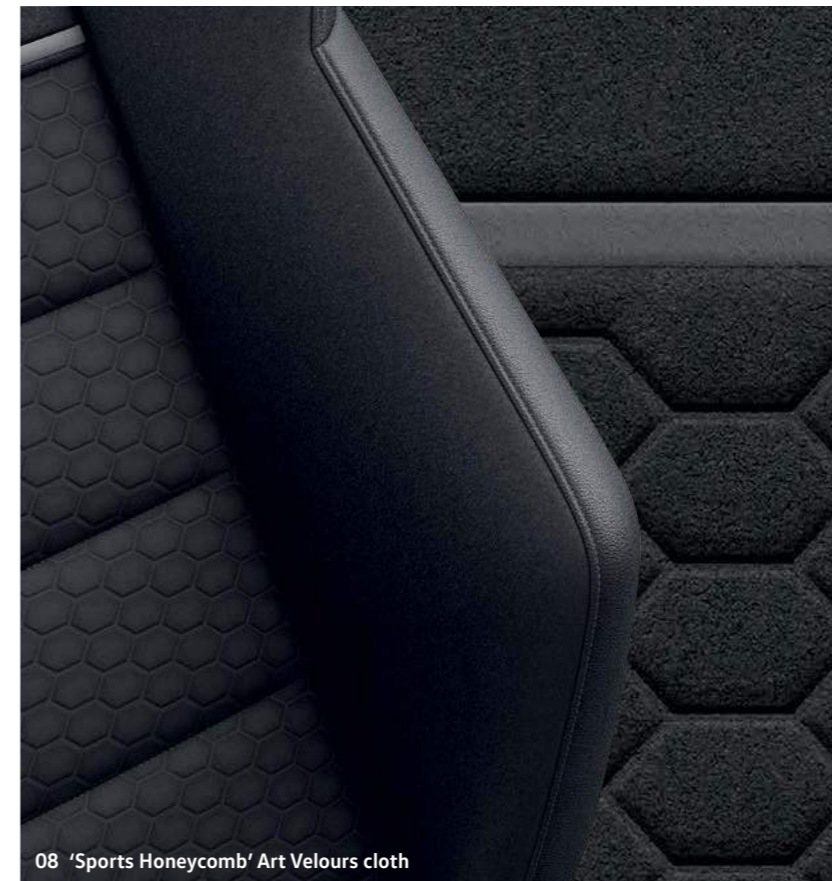

08 'Sports Honeycomb' Art Velours cloth

GO GTD GTE
GE GTD

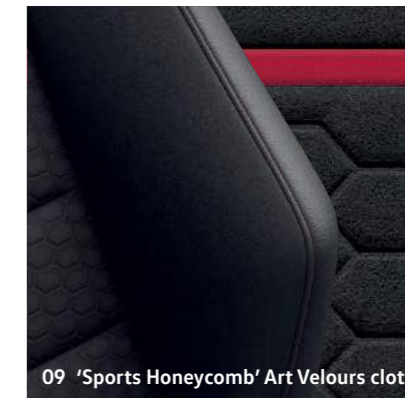

09 'Sports Honeycomb' Art Velours cloth

GO GTI



10 'Carbon/Nappa' leather

GO, GE R

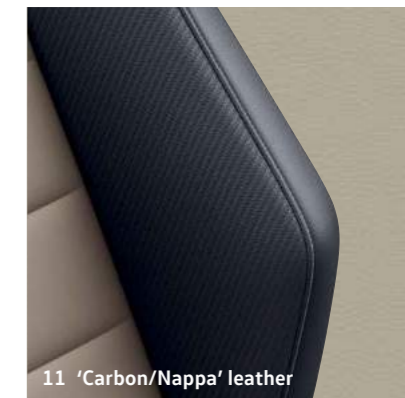

11 'Carbon/Nappa' leather

GO, GE R

Upholstery – Golf.

	Carpet	Dashboard	Pure White OQ Non-Metallic*1	Urano Grey 5K Non-Metallic	Tornado Red G2 Non-Metallic*	Turmeric Yellow 6T Metallic*	Reflex Silver 8E Metallic*	Isaac Blue Steel 8P Metallic*	Atlantic Blue H7 Metallic*	Tungsten Silver K5 Metallic*	White Silver K8 Metallic*	Cranberry Red V8 Metallic*	Indium Grey X3 Metallic*	Lapiz Blue L9 Metallic Signature*	Deep Black 2T Pearl Effect*	Oryx White OR Premium Signature*
'Bella' cloth Standard on S																
Titan Black (TW)	Black	Titan Black/Titan Black	●	●	●	●	●	-	●	●	●	●	●	-	●	-
'Zoom' cloth Standard on SE and SE Navigation models																
Titan Black (TW)	Black	Titan Black/Titan Black	●	●	●	●	●	-	●	●	●	●	●	-	●	●
Shetland (XW)	Black	Titan Black/Shetland	●	●	●	●	●	-	●	●	●	●	●	-	●	●
Art Velours seat centre section with 'Global' cloth side bolsters Standard on GT models																
Titan Black/Quartz (TW)	Black	Titan Black/Titan Black	●	●	●	●	●	-	●	●	●	●	●	-	●	●
Shetland/Shetland (XW)	Black	Titan Black/Shetland	●	●	●	●	●	-	●	●	●	●	●	-	●	●
'R-Line' cloth seat centre section with 'San Remo' microfibre side bolsters Standard on R-Line models																
Titan Black (TW)	Black	Titan Black/Titan Black	●	●	●	●	-	-	●	-	●	-	●	-	●	●
'Jacara Grey' cloth Standard on GTD and GTD BlueLine models																
Titan Black (TW)	Black	Titan Black/Titan Black	●	-	●	-	-	●	●	●	●	●	●	-	●	●
'Jacara Red' cloth Standard on GTI Performance models																
Titan Black/Red (TW)	Black	Titan Black/Titan Black	●	-	●	-	-	●	●	●	●	●	●	-	●	●
'Race' cloth seat centre section with grey Art Velours side bolsters Standard on R models																
Titan Black (TW)	Black	Titan Black/Titan Black	●	-	●	●	-	-	●	-	●	-	●	●	●	●
'Jacara Blue' cloth Standard on GTE and GTE Advance models																
Titan Black/Blue (TW)	Black	Titan Black/Titan Black	●	-	-	-	-	●	●	●	●	●	●	-	●	●
'Zoom' cloth Standard on e-Golf models																
Titan Black (TW)	Black	Titan Black/Titan Black	●	●	-	●	-	-	●	●	●	●	●	-	●	●

* Pure White and Tornado Red non-metallic, metallic, metallic signature, pearl effect, premium signature paints and leather upholstery are optional at extra cost.
 † Some parts of leather interior will contain artificial leather. Please note that from late November 2018, only the front seats are perforated and not the rear seats.
 ● Standard. ○ Optional at extra cost. - Not available.
 1 Pure White non-metallic paint is non-chargeable on GTE, GTE Advance, GTD, GTD BlueLine, GTI Performance and R models.

Due to unprecedented demand, leading to long delivery lead times, Golf GTE is currently temporarily closed to ordering. For full details please consult your authorised Volkswagen retailer or visit www.volkswagen.co.uk

	Carpet	Dashboard	Pure White OQ Non-Metallic*1	Urano Grey 5K Non-Metallic	Tornado Red G2 Non-Metallic*	Turmeric Yellow 6T Metallic*	Reflex Silver 8E Metallic*	Isaac Blue Steel 8P Metallic*	Atlantic Blue H7 Metallic*	Tungsten Silver K5 Metallic*	White Silver K8 Metallic*	Cranberry Red V8 Metallic*	Indium Grey X3 Metallic*	Lapiz Blue L9 Metallic Signature*	Deep Black 2T Pearl Effect*	Oryx White OR Premium Signature*
'Vienna' leather with perforated heated front sport seats*1 Optional on SE, SE Navigation, GT and e-Golf models																
Black (TW)	Black	Titan Black/Titan Black	○	○	○	○	○	-	○	○	○	○	○	-	○	○
Pure Grey (UW)	Black	Titan Black/Titan Black	○	○	○	○	○	-	○	○	○	○	○	-	○	○
Shetland (XW)	Black	Titan Black/Shetland	○	○	○	○	○	-	○	○	○	○	○	-	○	○
'Vienna' leather with perforated heated front sport seats*1 Optional on R-Line models																
Black (TW)	Black	Titan Black/Titan Black	○	○	○	○	-	-	○	-	○	-	○	-	○	○
'Vienna' leather with perforated heated front sport seats*1 Optional on GTD and GTD BlueLine models																
Black (TW)	Black	Titan Black/Titan Black	○	-	○	-	-	○	○	○	○	○	○	-	○	○
'Vienna' leather with perforated heated front sport seats*1 Optional on GTI Performance models																
Black/Red (TW)	Black	Titan Black/Titan Black	○	-	○	-	-	○	○	○	○	○	○	-	○	○
'Vienna' leather with perforated heated front sport seats*1 Optional on GTE and GTE Advance models																
Black (TW)	Black	Titan Black/Titan Black	○	-	-	-	-	○	○	○	○	○	○	-	○	○
'Vienna' leather with perforated heated front sport seats*1 Optional on R models																
Black (TW)	Black	Titan Black/Titan Black	○	-	○	○	-	-	○	-	○	-	○	○	○	○
'Sports Honeycomb' Art Velours cloth Optional on GTD and GTD BlueLine models																
Black/Flint Grey (TW)	Black	Titan Black/Titan Black	○	-	○	-	-	○	○	○	○	○	○	-	○	○
'Sports Honeycomb' Art Velours cloth Optional on GTE and GTE Advance models																
Black/Flint Grey (TW)	Black	Titan Black/Titan Black	○	-	-	-	-	○	○	○	○	○	○	-	○	○
'Sports Honeycomb' Art Velours cloth Optional on GTI Performance models																
Black/Red (TW)	Black	Titan Black/Titan Black	○	-	○	-	-	○	○	○	○	○	○	-	○	○
'Carbon/Nappa' leather*1 Optional on R models																
Black (TW)	Black	Titan Black/Titan Black	○	-	○	○	-	-	○	-	○	-	○	○	○	○
Grey (IB)	Black	Titan Black/Titan Black	○	-	○	○	-	-	○	-	○	-	○	○	○	○

* Pure White and Tornado Red non-metallic, metallic, metallic signature, pearl effect, premium signature paints and leather upholstery are optional at extra cost.
 † Some parts of leather interior will contain artificial leather. Please note that from late November 2018, only the front seats are perforated and not the rear seats.
 ● Standard. ○ Optional at extra cost. - Not available.
 1 Pure White non-metallic paint is non-chargeable on GTE, GTE Advance, GTD, GTD BlueLine, GTI Performance and R models.

Due to unprecedented demand, leading to long delivery lead times, Golf GTE is currently temporarily closed to ordering. For full details please consult your authorised Volkswagen retailer or visit www.volkswagen.co.uk



Upholstery – Golf Estate.

'Bella' cloth Standard on S

Carpet	Dashboard	Pure White OQ Non-Metallic*1	Urano Grey 5K Non-Metallic	Tornado Red G2 Non-Metallic*	Turmeric Yellow G1 Metallic*	Reflex Silver 8E Metallic*	Isaac Blue Steel 8P Metallic*	Atlantic Blue H7 Metallic*	Tungsten Silver K5 Metallic*	White Silver K8 Metallic*	Cranberry Red V8 Metallic*	Indium Grey X3 Metallic*	Lapiz Blue L9 Metallic Signature*	Deep Black 2T Pearl Effect*	Oryx White OR Premium Signature*
Titan Black (TW)	Titan Black/Titan Black	●	●	●	●	●	-	●	●	●	●	●	-	●	-

'Zoom' cloth Standard on SE and SE Navigation models

Titan Black (TW)	Titan Black/Titan Black	●	●	●	●	●	-	●	●	●	●	●	-	●	●
Shetland (XW)	Titan Black/Shetland	●	●	●	●	●	-	●	●	●	●	●	-	●	●

Art Velours seat centre section with 'Global' cloth side bolsters Standard on GT models

Titan Black/Quartz (TW)	Titan Black/Titan Black	●	●	●	●	●	-	●	●	●	●	●	-	●	●
Shetland/Shetland (XW)	Titan Black/Shetland	●	●	●	●	●	-	●	●	●	●	●	-	●	●

'Jacara Grey' cloth Standard on GTD and GTD BlueLine models

Titan Black (TW)	Titan Black/Titan Black	●	-	●	-	-	●	●	●	●	●	●	-	●	●
------------------	-------------------------	---	---	---	---	---	---	---	---	---	---	---	---	---	---

'Race' cloth seat centre section with grey Art Velours side bolsters Standard on R models

Titan Black (TW)	Titan Black/Titan Black	●	-	●	●	-	-	●	-	●	-	●	●	●	●
------------------	-------------------------	---	---	---	---	---	---	---	---	---	---	---	---	---	---

'Alltrack' cloth seat centre section with Alcantara side bolsters Standard on Alltrack models

Titan Black (TW)	Titan Black/Titan Black	●	●	●	-	-	-	-	●	●	●	●	-	●	●
------------------	-------------------------	---	---	---	---	---	---	---	---	---	---	---	---	---	---

'Vienna' leather with perforated heated front sport seats*† Optional on SE, SE Navigation and GT models

Black (TW)	Titan Black/Titan Black	○	○	○	○	○	-	○	○	○	○	○	-	○	○
Pure Grey (UW)	Titan Black/Titan Black	○	○	○	○	○	-	○	○	○	○	○	-	○	○
Shetland (XW)	Titan Black/Shetland	○	○	○	○	○	-	○	○	○	○	○	-	○	○

'Vienna' leather with perforated heated front sport seats*† Optional on GTD and GTD BlueLine models

Black (TW)	Titan Black/Titan Black	○	-	○	-	-	○	○	○	○	○	○	-	○	○
------------	-------------------------	---	---	---	---	---	---	---	---	---	---	---	---	---	---

'Vienna' leather with perforated heated front sport seats*† Optional on R models

Black (TW)	Titan Black/Titan Black	○	-	○	○	-	-	○	-	○	-	○	○	○	○
------------	-------------------------	---	---	---	---	---	---	---	---	---	---	---	---	---	---

'Vienna' leather with perforated heated front sport seats*† Optional on Alltrack models

Black (TW)	Titan Black/Titan Black	○	○	○	-	-	-	-	○	○	○	○	-	○	○
Pure Grey (UW)	Titan Black/Titan Black	○	○	○	-	-	-	-	○	○	○	○	-	○	○

'Sports Honeycomb' Art Velours cloth Optional on GTD and GTD BlueLine models

Black/Flint Grey (TW)	Titan Black/Titan Black	○	-	○	-	-	○	○	○	○	○	○	-	○	○
-----------------------	-------------------------	---	---	---	---	---	---	---	---	---	---	---	---	---	---

'Carbon/Nappa' leather*† Optional on R models

Black (TW)	Titan Black/Titan Black	○	-	○	○	-	-	○	-	○	-	○	○	○	○
Grey (IB)	Titan Black/Titan Black	○	-	○	-	-	-	○	-	○	-	○	○	○	○

* Pure White and Tornado Red non-metallic, metallic, metallic signature, pearl effect, premium signature paints and leather upholstery are optional at extra cost.
† Some parts of leather interior will contain artificial leather. Please note that from late November 2018, only the front seats are perforated and not the rear seats.

● Standard. ○ Optional at extra cost. - Not available.

1. Pure White non-metallic paint is non-chargeable on GTD, GTD BlueLine and R models.

Dimensions – Golf.

Exterior dimensions	S, SE, SE Navigation, GT, R-Line	GTD, GTD BlueLine, GTI Performance	R	GTE, GTE Advance	e-Golf
Length – min., mm	4258	4268	4263	4276	4270
Width – excl. door mirrors – 3-door/5-door min./max., mm	1790/1799	1790/1799	1790/1799	1799/1799	1790/1799
Height – max., mm	1492	1482	1465	1484	1482
Height – opened tailgate/floor, mm	2006	1996	1990	2016	2002
Wheelbase, mm	2620	2626	2626	2630	2629
Turning circle, m	10.9	10.9	10.9	10.9	10.9

Interior dimensions	S, SE, SE Navigation, GT, R-Line	GTD, GTD BlueLine, GTI Performance	R	GTE, GTE Advance	e-Golf
Effective headroom – front, mm (with sunroof)	1018 (999)	1018 (999)	1018 (999)	1018 (999)	1018 (999)
Effective headroom – rear, mm (with sunroof)	967 (967)	967 (967)	967 (967)	967 (967)	967
Interior width, front – 3-door/5-door, mm	1469	1469	1469	1469	1469
Interior width, rear – 3-door/5-door, mm	1440	1440	1440	1440	1440

Maximum luggage capacity, litres VDA measuring method using 200 x 100 x 50mm blocks

With rear seats upright	380	380	343	272	341
With rear seats folded	1270	1270	1233	1162	1231

Figures shown are for standard specification models. The addition of certain factory-fitted options and/or accessories may affect some of the dimensions shown.

On illustrations, where arrows and figures are shown inside of the vehicle, the measurements are for interior dimensions. Where arrows and figures are shown outside of the vehicle, the measurements are for exterior dimensions.

Due to unprecedented demand, leading to long delivery lead times, Golf GTE is currently temporarily closed to ordering. For full details please consult your authorised Volkswagen retailer or visit www.volkswagen.co.uk

S, SE, SE Navigation, GT, R-Line

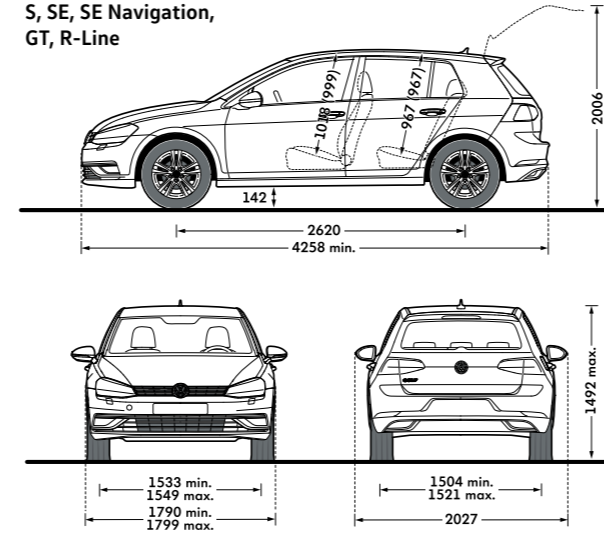

GTD, GTD BlueLine, GTI Performance

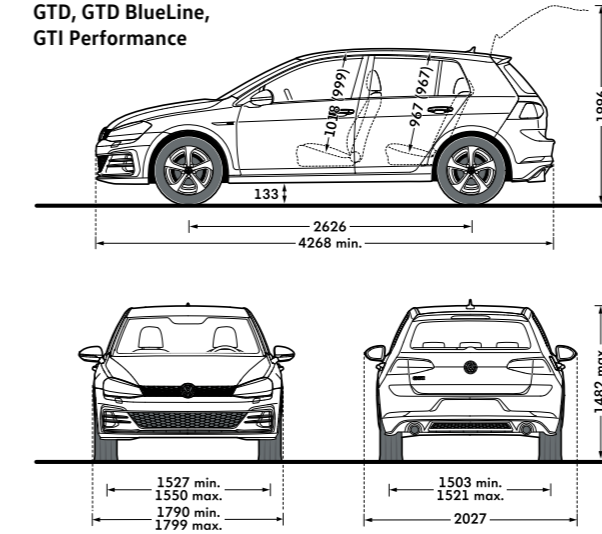

e-Golf

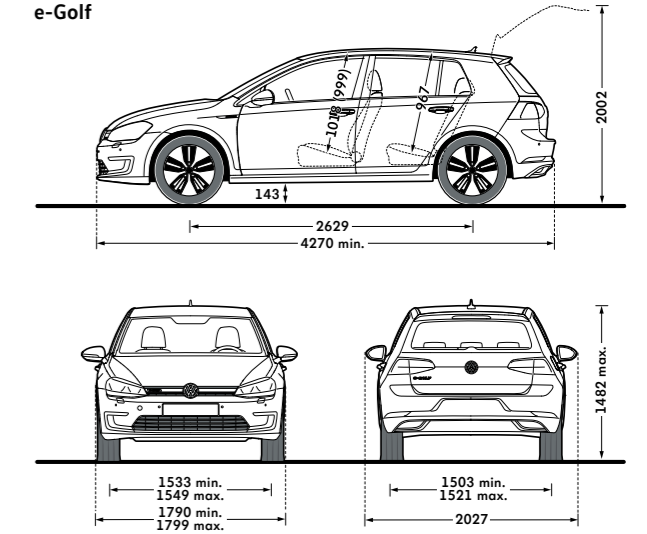

R

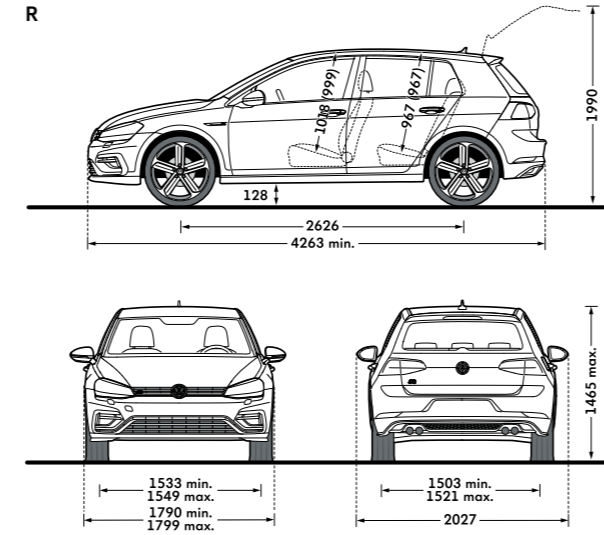

GTE, GTE Advance

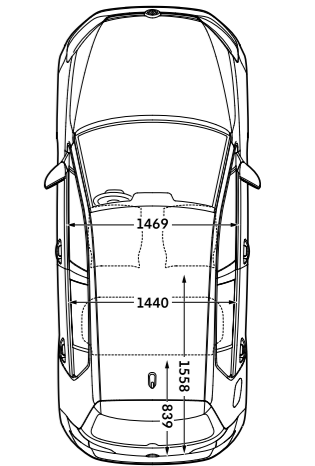
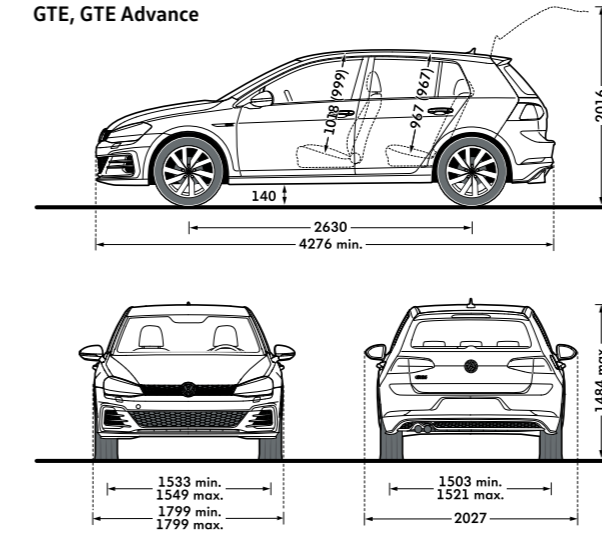

Dimensions – Golf Estate.

Exterior dimensions	S, SE, SE Navigation, GT	GTD, GTD BlueLine	R	Alltrack
Length – min., mm	4567	4567	4586	4567
Width – excl. door mirrors – 3-door/5-door min./max., mm	1799/1799	1799/1799	1799/1799	1799/1799
Height – max., mm	1515	1515	1515	1515
Height – opened tailgate/floor, mm	2020	2020	2020	2020
Wheelbase, mm	2620	2620	2620	2629
Turning circle, m	10.9	10.9	10.9	10.9

Interior dimensions	S, SE, SE Navigation, GT	GTD, GTD BlueLine	R	Alltrack
Effective headroom – front, mm (with sunroof)	1025 (994)	1025 (994)	1025 (994)	1025 (994)
Effective headroom – rear, mm (with sunroof)	980 (972)	980 (972)	980 (972)	980 (972)
Interior width, front – 3-door/5-door, mm	1469	1469	1469	1469
Interior width, rear – 3-door/5-door, mm	1441	1441	1441	1441

Maximum luggage capacity, litres VDA measuring method using 200 x 100 x 50mm blocks

With rear seats upright	605	605	605	605
With rear seats folded	1620	1620	1620	1620

Figures shown are for standard specification models. The addition of certain factory-fitted options and/or accessories may affect some of the dimensions shown.

On illustrations, where arrows and figures are shown inside of the vehicle, the measurements are for interior dimensions. Where arrows and figures are shown outside of the vehicle, the measurements are for exterior dimensions.

S, SE, SE Navigation, GT

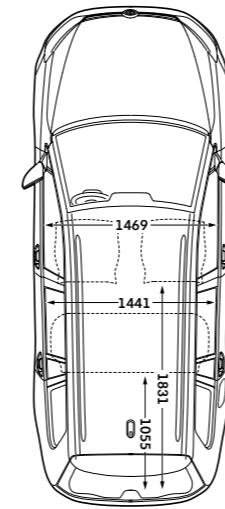
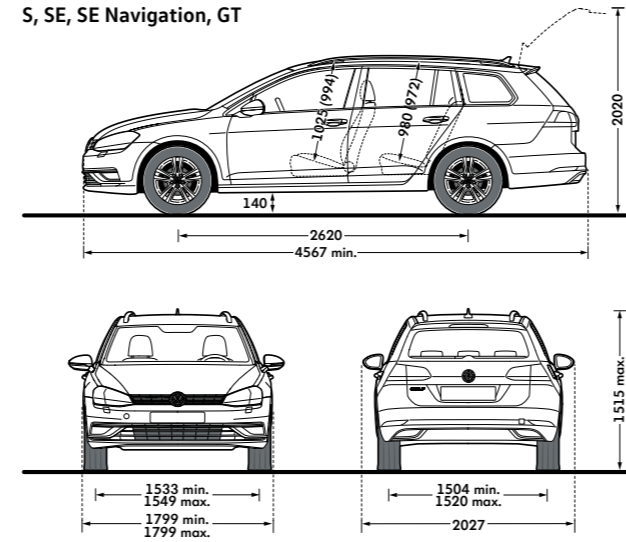

GTD, GTD BlueLine

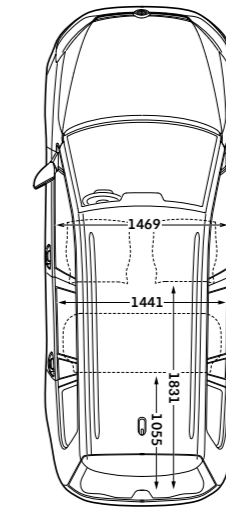
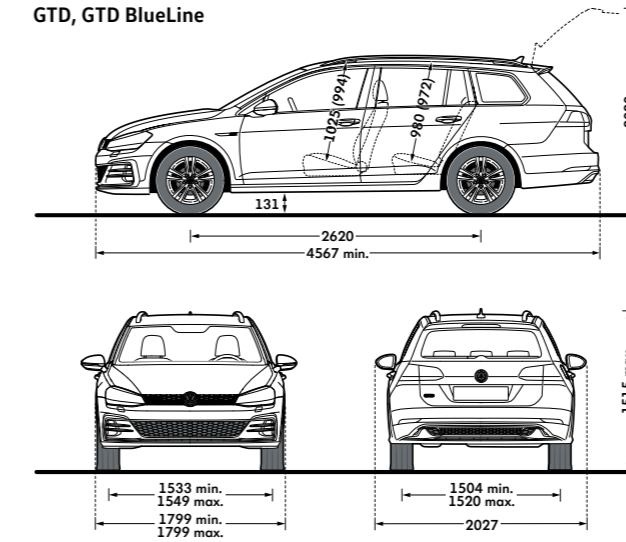

R

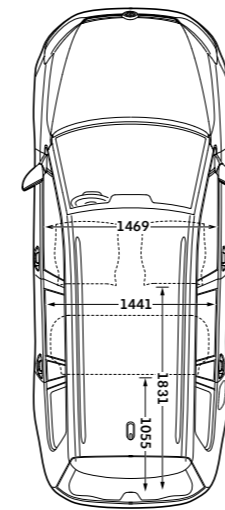
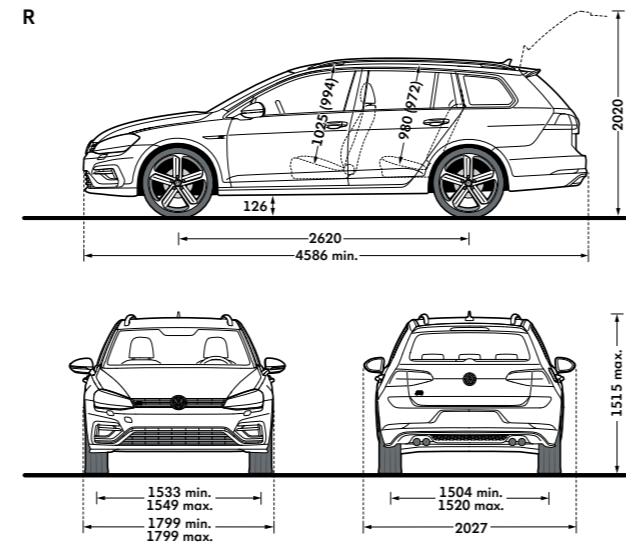

Alltrack

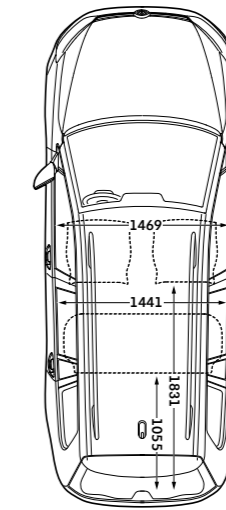
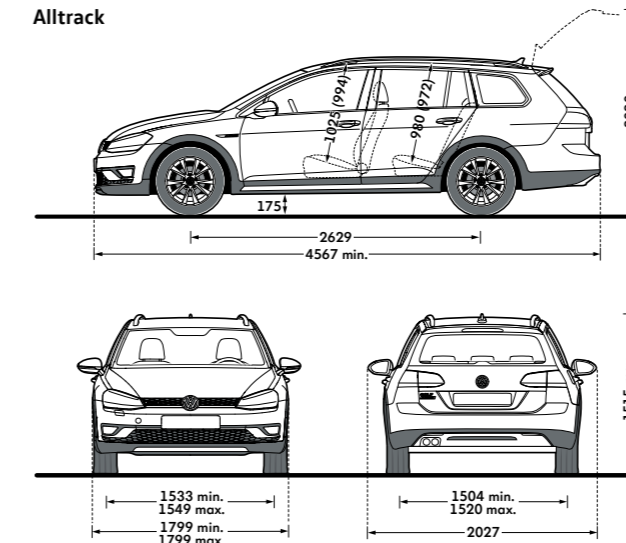

Volkswagen service.

Exclusions and terms and conditions apply to all warranties and plans listed. For pricing and further details of Volkswagen Warranties and Service Plans, please consult your authorised Volkswagen retailer or repairer, or visit www.volkswagen.co.uk

The Volkswagen Warranty

Three-year Warranty

All Volkswagen passenger cars come with a three-year/60,000 miles warranty, which protects your car against the failure of most technical and electrical components due to manufacturing defects. This comprises a two-year manufacturer's warranty with unlimited mileage plus a further one-year/60,000 miles (whichever is soonest) Retailer Warranty¹. Should the mileage exceed 60,000 miles within the first two years, the manufacturer's two-year warranty will still be valid. Full details of the three-year warranty are available from your authorised Volkswagen retailer or repairer.

Body Protection Warranty

The internal body sections and panels of the Golf and Golf Estate are covered against rusting through from the inside for 12 years. Naturally, the vehicle must be cared for in compliance with the manufacturer's operating instructions. Please consult your authorised Volkswagen retailer or repairer for full warranty details.

Three-year Paintwork Warranty

This latest paintwork warranty, pioneered by Volkswagen, provides you with cover on a new car. Naturally, during the warranty period the car must be cared for in compliance with the manufacturer's operating instructions. Any paintwork defects, as a result of the manufacturing process, will be rectified without charge.

Approved Accessories

A comprehensive range of accessories from alloy wheels to carpet mats is available to complement the factory-fitted option list. Volkswagen approved accessories purchased from and fitted by your authorised Volkswagen retailer at the point of vehicle sale will also benefit from the three-year vehicle warranty.

Volkswagen Insurance⁴

We want you to start enjoying your new car from day one and thanks to Volkswagen free 5 day insurance, you can. Call free on 0330 303 6930 (lines are open Monday to Friday 8am – 9pm and Saturday 9am – 5pm), provide a few details and a cover note will be sent to your retailer. They will then tax your car and you can drive it away.

Service Intervals

Volkswagen is pleased to offer you a choice on how your Volkswagen is serviced. The appropriate selection is entirely dependent on how the car is likely to be driven and its general use. To help you identify which type of service would be most suitable, please refer to the following guide.

The Fixed Service is recommended for vehicles that will cover less than 10,000 miles in 12 months and if the vehicle is likely to be used in the following way:

- Predominantly urban driving, short journeys with frequent cold starts.
 - Activities regularly producing high engine loading, e.g. frequent hill climbs, driving with vehicle fully loaded and towing.
 - Uneconomical driving style using high rpms with heavy acceleration and heavy braking.
- The service intervals for the Fixed Service are as follows:
- Oil change service – After 1 year or 10,000 miles (15,000km), whichever is soonest.
 - Inspection service² – First after 2 years or 20,000 miles (30,000km), then every one year or 20,000 miles (30,000km), whichever is soonest.

The Flexible Service is recommended for vehicles with daily mileage of more than 25 miles where the vehicle is driven regularly mainly on longer distance journeys. The vehicle is driven mainly at a constant speed with minimum vehicle and engine loading, minimal towing and driven in an economical manner. With the Flexible Service the vehicle can cover anywhere between 10,000³ and a maximum of 20,000³ miles or 24 months (whichever is soonest) between oil changes.

The service intervals for the Flexible Service are as follows:

- Oil change service – According to flexible service interval display (after 2 years at the latest).
- Inspection service² – First after 2 years or 20,000 miles (30,000km), then every one year or 20,000 miles (30,000km), whichever is soonest.

The up! model is only available with the Fixed Service schedule. Please consult your authorised Volkswagen retailer or repairer for advice and full details.

Please note: If you purchase a Volkswagen Fixed Price Service Plan your vehicle will follow the Fixed Service schedule.

Electric vehicles: Vehicles powered only by an electric motor require a Fixed Service as follows:

- Inspection service – First service after 20,000 miles (30,000km)/2 years, whichever is soonest.
- Subsequent services every 20,000 miles (30,000km)/1 year, whichever is soonest.

Please note: If you purchase a Volkswagen Fixed Price Service Plan your vehicle will follow the Fixed Service schedule.

Volkswagen Insurance⁵

Get three years' Volkswagen Insurance cover for free.

Another great benefit of being a Volkswagen driver. If your Volkswagen was damaged in an accident, wouldn't you want it fixed by a Volkswagen trained technician using only genuine Volkswagen parts? Insurance is Volkswagen's accident and repair cover which does exactly that. It works alongside your main comprehensive motor insurance policy no matter who you are insured with, to make sure you get the quality repair and service you would want. If you're involved in an accident or your car is stolen, just one call to us and we'll look after your claim from start to finish ensuring your Volkswagen is restored to the highest standard.

Activate your cover and benefit from:

- A guarantee that your Volkswagen will be repaired by a Volkswagen approved repairer and Volkswagen trained technicians, using only genuine Volkswagen parts and paints.
- A dedicated Claims Manager who will manage your claim from start to finish, liaising with your insurer and the repairer so you don't have to.
- Help to recover any uninsured losses using our Legal Expenses Cover.
- Online claims tracking so you can keep up to date with the status of any claim.

Volkswagen Insurance is free to all Volkswagen customers for three years and it only takes a minute to get cover. To find out more and to activate your cover, visit www.volkswagen-insurance.co.uk

Volkswagen Finance⁶

Volkswagen Finance specialises in providing funding solutions for Volkswagen drivers. Whether your Volkswagen is for private or business use, you can choose from a range of funding options.

- Solutions – a Personal Contract Plan
- Hire purchase
- Lease purchase
- Finance lease
- Contract hire

With all Volkswagen Finance products you can choose a fixed-cost maintenance plan to help you budget for your servicing and maintenance costs. No matter what finance product you choose, your local Volkswagen retailer will be able to provide you with a personalised quote that could meet your budget and vehicle needs.

Fuel consumption and CO₂ Emissions

Fuel consumption and CO₂ figures are obtained under standardised EU test conditions (Directive 93/116/EEC). This allows a direct comparison between different manufacturer models but may not represent the actual fuel consumption achieved in 'real world' driving conditions. More information is available on the Volkswagen website at www.volkswagen.co.uk and at www.dft.gov.uk/vca. The weight of a vehicle will influence the level of CO₂ emissions it produces; as a result, vehicles with higher levels of specification and factory-fitted options may emit higher levels of CO₂. Choosing larger alloy wheels than those fitted as standard may result in increased fuel consumption as well as higher CO₂ emissions and subsequently an increased Vehicle Excise Duty (VED) band. BIK rates paid by company car drivers may also increase. In some instances, the recommended 'On the road' retail price paid for a vehicle may increase as a result of the increased VED rate. CO₂ is the main greenhouse gas responsible for global warming. The specifications contained in this brochure are for information purposes only and are subject to change.

Volkswagen Roadside Assistance

Every new car is registered for Volkswagen Roadside Assistance for one year except the Touareg which is registered for three years. This provides vehicle roadside and home recovery in the unlikely event of a breakdown in the UK and Europe (subject to conditions). Volkswagen Roadside Assistance can also be purchased for subsequent years.

Exclusions and terms and conditions apply. For pricing and further details of Volkswagen Roadside Assistance, please consult your authorised Volkswagen retailer, or visit www.volkswagen.co.uk

Volkswagen e-golf and GTE eight-year Battery Warranty

1. A guarantee for eight years or 99,360 miles/160,000km (whichever is soonest), on all material or manufacturing defects.
2. Gradual reduction in battery capacity over times is integral to the nature of the component, and does not represent a defect under the terms of this guarantee, as long as the reduction in capacity is not in excess of the value specified for this vehicle in the owner's manual.
3. With the exception of the warranty term, all warranty conditions stipulated by the Volkswagen retailer selling the vehicle (prerequisites, criteria for freedom from defects, exclusions, settlement of claims, entry into force and start of extended warranty term, scope of application etc.) also apply to the high voltage battery.

Volkswagen e-Golf and GTE Specialist Retailer Network

e-Golf and GTE models are only available for sale through an authorised specialist Volkswagen retailer. These retailers have the ability to provide the highest levels of service when purchasing your e-Golf or GTE model. For details of your nearest authorised specialist Volkswagen retailer, please visit volkswagen.co.uk for more details.

EV and PHEV vehicle

Home charging using a domestic socket will depend on the condition and suitability of the wiring in your home. Always consult a qualified electrician before charging when using a domestic socket for the first time, or, if the socket is to be used as the primary source of charging. Domestic sockets on the same circuit as other appliances, particularly those in frequent use, will draw additional amperage which may result in a breaker switch being 'tripped'. Establishing a separate circuit for home charging will help ensure your electric vehicle is supplied with a consistent, uninterrupted current. For optimum charging, we recommend installing an electric vehicle charging point at home.

Tax Free Sales

For full details, please contact your authorised Volkswagen retailer.

Please note:

Some illustrations in this brochure do not necessarily reflect UK specifications and may not be available. In particular, controls and some items of equipment are positioned differently for the UK. The specifications contained in this brochure are for information purposes only and are subject to change. If you require any specific feature, you must consult your authorised Volkswagen retailer who is regularly updated with any change in specification. Please check model availability and full specification details with your authorised Volkswagen retailer prior to ordering. Note: we would like to advise you that telephone calls to Volkswagen Customer Care may be monitored and recorded as part of our training and quality assurance processes. All our monitoring and recording processes meet OfTel regulations.

¹ All warranty work must be completed by an authorised Volkswagen retailer or repairer.

² The inspection service first at 3 years (or 40,000 miles) and then every second year (or 40,000 miles) has additional workscope.

³ The quoted mileage is based on a conversion from kilometres and is therefore unlikely to exceed circa 18,000 miles between oil changes.

⁴ Volkswagen Car Insurance is underwritten by U K Insurance Limited. Registered Office: The Wharf, Neville Street, Leeds LS1 4AZ. Registered in England and Wales number: 1179980. U K Insurance Limited is authorised by the Prudential Regulation Authority and regulated by the Financial Conduct Authority (FCA) and the Prudential Regulation Authority. Calls may be recorded. Volkswagen Financial Services is a trading name of Volkswagen Financial Services (UK) Limited ('VWFS UK'), registered in England and Wales number: 2835230 (Registered Office: Brunswick Court, Yeomans Drive, Blakelands, Milton Keynes MK14 5LR). Volkswagen Insurance Service (Great Britain) Ltd. is an appointed representative of VWFS UK. VWFS UK is authorised and regulated by the FCA, registration number: 311988. Authorisation details for both organisations can be checked on the Financial Services Register by visiting www.fca.org.uk. VWFS UK and U K Insurance Limited are not part of the same corporate group.

⁵ Insurance from Volkswagen Financial Services is sold and administered by Lawshield UK Limited, registered in England number: 3360532. Registered office: Lawshield House, 850 Ibis Court, Lakeside Drive, Centre Park, Warrington, Cheshire, WA1 1RL and underwritten by UK General Insurance Limited on behalf of Great Lakes Insurance SE. Great Lakes Insurance SE is a German insurance company with its headquarters at Königinstrasse 107, 80802 Munich. UK Branch office: Plantation Place, 30 Fenchurch Street, London, EC3M 3AJ. Lawshield UK Limited is authorised and regulated by the Financial Conduct Authority (FCA). Authorisation details can be checked on the FCA's register at www.fca.org.uk. Great Lakes Insurance SE, UK Branch, is authorised by Bundesanstalt für Finanzdienstleistungsaufsicht and subject to limited regulation by the Financial Conduct Authority and Prudential Regulation Authority. Details about the extent of their regulation by the Financial Conduct Authority and Prudential Regulation Authority are available on request.

⁶ Finance is available to 18s and over, subject to status. Terms and conditions apply. Volkswagen Finance.

The Golf and Golf Estate

Volkswagen Information Service. Telephone: 0800 333 666

Internet: www.volkswagen.co.uk

© Volkswagen Group United Kingdom Limited 2018.

Issue: 13 September 2018



facebook.com/VolkswagenUK



[@UKVolkswagen](https://twitter.com/@UKVolkswagen)



youtube.com/user/ukvolkswagen