

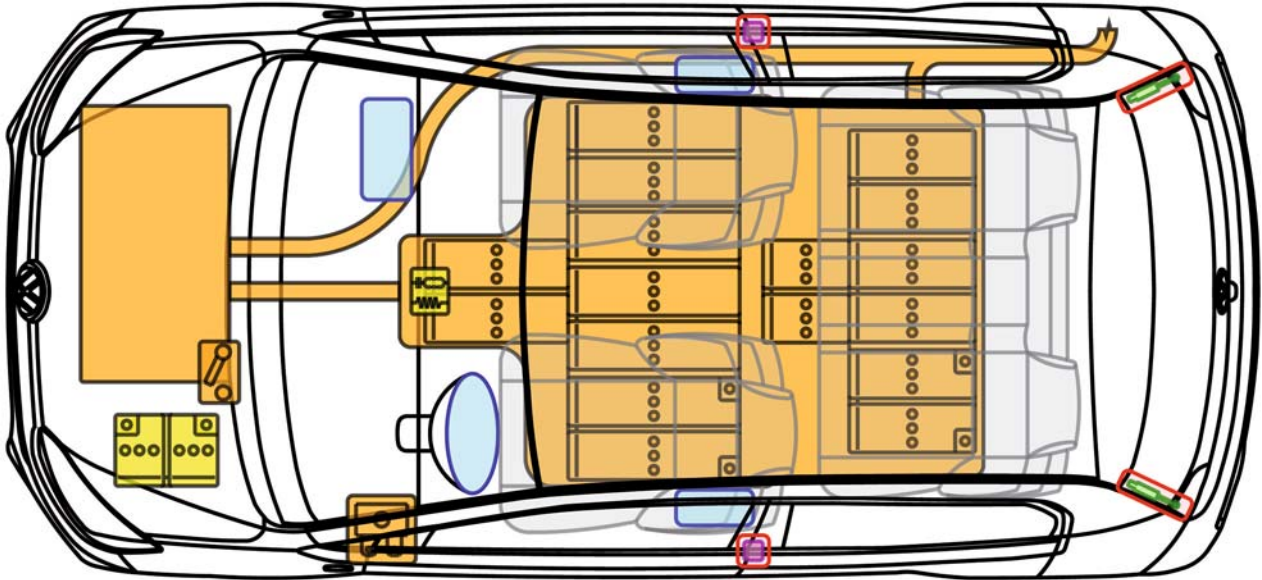

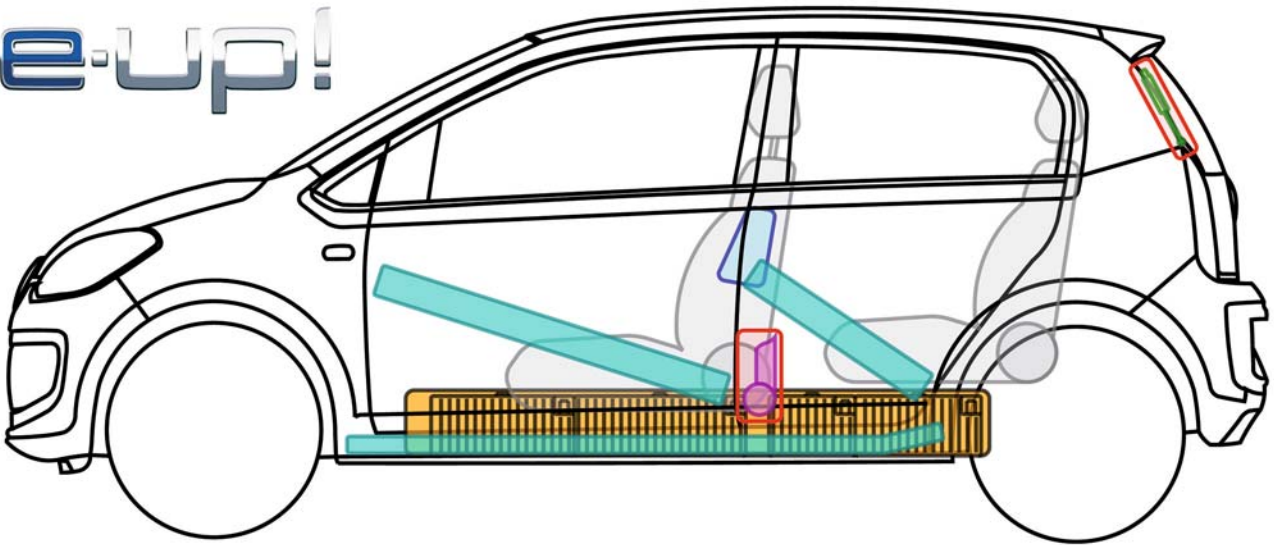











e-up!
(from 2013)



e-up!



Key

	Airbag		Body reinforcement		Control unit		High-voltage battery
	Gas generator				12 V battery		High-voltage component/wiring
	Belt tensioner		Gas strut		Fuel tank		High-voltage disconnecting point



e-up!
(from 2013)



Vehicle identification

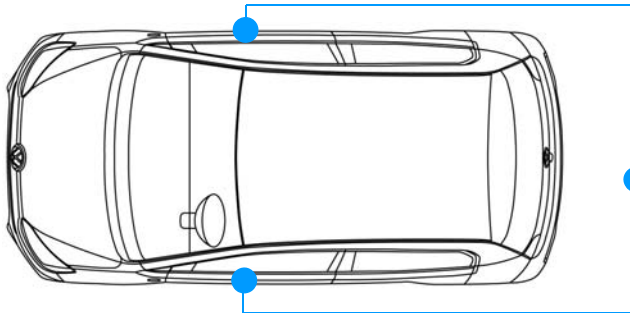

Lettering on doors and rear hatch



Prevent the vehicle from rolling

1. Put the selector lever in the Park (P) position.
2. Apply the parking brake.

Deactivate the drive and the high-voltage system

Deactivating the drive and the high-voltage system
(when ignition and fuse carrier can be accessed from the interior)

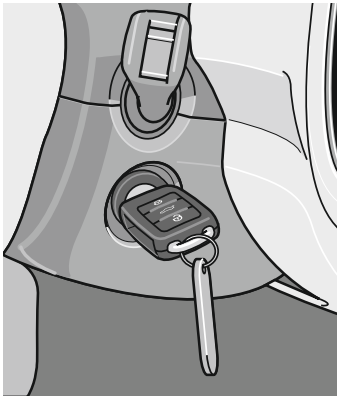

1. Turn the ignition key to the “OFF” position and remove it.



Removing the ignition key deactivates passive safety systems such as airbags and belt tensioners once the airbag control unit has discharged (approx. 4 seconds). Working on the system before the unit has discharged may damage the airbag system, causing the airbags to be triggered.

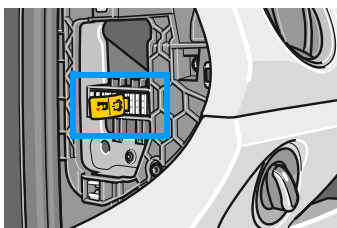

2. Remove the cover of the dashboard fuse holder on the left. Pull out the marked fuse. (yellow flag)



The high-voltage system will be de-energised about 20 seconds after deactivation. The passive safety systems such as airbags and belt tensioners are then deactivated.





e-up!
(from 2013)



Deactivate the drive and the high-voltage system

Deactivating the drive and the high-voltage system
(when motor compartment is accessible).

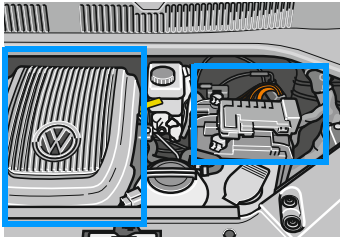

1. Disconnect 12 V battery
2. Remove motor cover

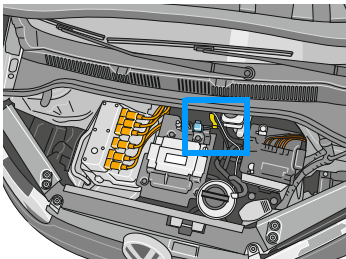

3. Locate rescue disconnecting point

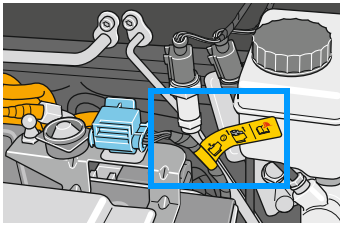

4. Open rescue disconnecting point
The procedure is described on the tag.



The high-voltage system will be de-energised about 20 seconds after deactivation. The passive safety systems such as airbags and belt tensioners are then deactivated.



Vehicles connected to charging pillars

Unlock vehicle. Disconnect the charging cable from the vehicle and, in the event of a severe accident, deactivate the vehicle's high-voltage system (see "Deactivating the vehicle").